



Infraestructura e Industria

Tarifa 2024
Marzo 2024





Editorial

Otro año más, otra tarifa más, y una nueva oportunidad para agradecer la confianza depositada en Aliaxis y en todas nuestras marcas.

Sin vosotros, este proyecto de innovación, crecimiento y sostenibilidad que es Aliaxis no sería posible.

Creo que estamos todos un poco cansados de hablar de incertidumbre, volatilidad, inflación..., por eso, voy a hablaros de cariño y positivismo, sí, del cariño y positivismo que vivimos en Aliaxis, y con el que diseñamos y construimos este catálogo.

En Aliaxis, apostamos por la innovación, por la sostenibilidad y por el servicio. Nuestro objetivo es ayudaros a dar soluciones fiables a vuestros clientes con las que crecer. Por eso, os ponemos en el centro de nuestras decisiones y buscamos que cada proyecto tenga impacto POSITIVO en vosotros.

Entre 2022 y 2023 hemos invertido más de 14 millones de euros, y tenemos planes de inversión que superarán estas cifras. Todo ello para mejorar nuestras fábricas y desarrollar nuevas soluciones sostenibles que ayuden al planeta.

Hoy;

- ✓ Ya usamos un 22% de energía renovable de autoconsumo en nuestras plantas y llegaremos al 100% en 2025.
- ✓ Hemos reducido el 12% de nuestras emisiones de CO2.
- ✓ Hemos reducido el consumo de agua un 30% y queremos llegar el 50% en 2024.
- ✓ Tenemos la certificación OCS en Alicante y la tendremos en nuestra planta de Álava para antes del primer trimestre de 2024.
- ✓ Tenemos el objetivo de cero residuos a vertedero, que alcanzaremos durante el 2024.
- ✓ Hemos lanzado el primer sifón hecho íntegramente 100% con polipropileno reciclado, y con un envase de cartón 100% reciclado.
- ✓ Hemos incorporado ZYPHO a la familia de Aliaxis, y presentamos al mercado el recuperador de energía térmica más eficiente, con reducción de hasta un 75% del consumo de energía en el agua caliente de la ducha.
- ✓ Hemos lanzado la nueva gama de tubería y accesorios PPH
- ✓ Hemos lanzado el primer portal para distribuidores on-line "Mi Aliaxis" con vosotros y seguiremos añadiendo funcionalidades nuevas en 2024
- ✓ Hemos invertido en formación de nuestro equipo humano para garantizar que el cuidado y la atención experta a vosotros sea un hecho diferencial de nuestra empresa y nuestra marca.

Y muchos más proyectos que estamos desarrollando y de los que os haremos partícipes.

Si como dijo alguien, la economía es un estado de ánimo, junto con vosotros, y GRACIAS VOSOTROS, vamos a hacer de 2024 un año muy POSITIVO.

Con cariño y enorme agradecimiento, os envío un afectuoso saludo,

Jorge Barranco

Vicepresidente Aliaxis Iberia

Bienvenido a

aliaxis

El cambio positivo que se hace realidad

En Aliaxis, nuestro propósito es brindar soluciones a los desafíos hídricos del mundo y acelerar la transición hacia la energía limpia.

Líderes en el sector

Ya son más de cinco décadas de experiencia en 4 segmentos clave:



EDIFICACIÓN



INFRAESTRUCTURA



INDUSTRIA

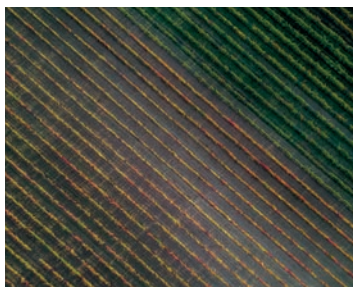

AGRICULTURA



Escanea el código para descargar las tarifas de:

- Edificación y Riego
- Infraestructura e Industria

Aliaxis: una gran compañía en expansión



Corazón local. Espíritu global

Operamos en más de 40 países y diseñamos soluciones sostenibles, fáciles de instalar e innovadoras.

Gracias a nuestros más de 14.000 empleados, nuestros sistemas de tuberías y accesorios satisfacen las necesidades más exigentes de nuestros clientes en los sectores de construcción, infraestructura, industria y agricultura.

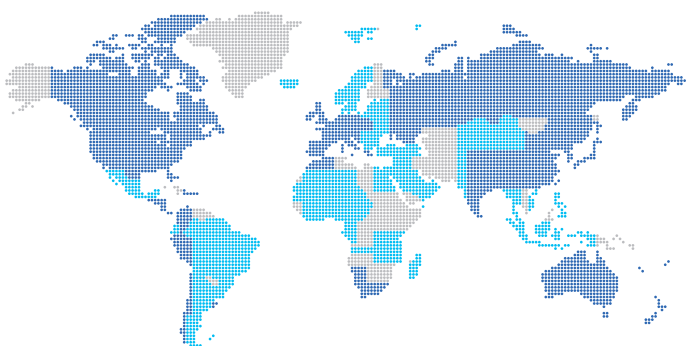

Conoce más sobre nuestras fábricas en España



Alicante

El origen de nuestras soluciones en sanitario

- + 55 años de experiencia
- 80.000 m²
- + 500 empleados



Okondo

El origen de nuestras soluciones para infraestructura

- + 30 años de experiencia
- 5.000 m²
- + 100 empleados



Para más información consulta alixis.es

FINALES DE CARRERA MECÁNICOS E INDUCTIVOS

Fácil instalación con gran versatilidad de uso, incluso en ambientes corrosivos.

AMPLIACIÓN DE GAMA



Encuétralo en:
Tarifa Infraestructura e Industria, pág. 449

ACCESORIOS PP-H

Nuevas curvas 90°.

Cuenta con 8 marcas orientables que permiten la correcta alineación en todas las direcciones del tubo durante su instalación.

Tiene una superficie interna pulida que minimiza la sedimentación de impurezas.

REDISEÑADAS Y MEJORADAS



Encuétralo en:
Tarifa Infraestructura e Industria, pág. 324

FLEXIPOL FM

Nuestras tuberías cuentan con certificado FM para instalaciones enterradas de PEAD contraincendios.

Nuevos diámetros: Ø 63 ,75 ,125 y 140 mm.

Más información en:



NUEVOS DIÁMETROS



Encuétralo en:

Tarifa Infraestructura e Industria, pág. 10

ACCESORIOS MANIPULADOS

Contamos con un taller especializado al lado de nuestra fábrica de tuberías de polietileno donde realizamos el diseño y producción de accesorios a medida.

Gracias a nuestro sistema de soldadura a tope, las uniones son resistentes y de alto rendimiento.

AMPLIACIÓN DE GAMA

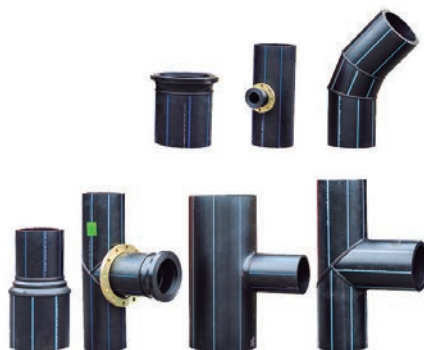

Encuétralo en:

Tarifa Infraestructura e Industria, pág. 42

SIFONES FLEXIBLES DE GOMA

Muy fáciles de instalar.

Gama disponible con accesorios de válvula y racor.



Encuétralo en:

Tarifa Edificación y Riego, pág. 39

LINNUM ALTURA REDUCIDA

Con una altura de sifón de tan solo 30 mm.

Permite una instalación al ras del suelo.



Encuétralo en:

Tarifa Edificación y Riego, pág. 76

LINNUM CERCO OCULTO

En acabado negro mate y con diseño reversible.

Al voltear la rejilla obtendrás un marco rellenable que te permitirá conseguir acabados con otros materiales (cerámica, mármol, cristal, entre otros).



Encuétralo en:

Tarifa Edificación y Riego, pág. 76

VÁLVULAS CLICK CLACK

Adaptables a todo tipo de diseño gracias a la variedad de acabados, tapones y dimensiones.

Integrable a todo tipo de lavabo, hasta en aquellos de de altura reducida.

Más información en:



ENLACES DE 3 PIEZAS PP-RCT

Ampliación de gama sistema WF/PP-R agua caliente y fría.

Nuevas piezas que permiten desmontarse y hacer uniones por ambos lados, facilitando el trabajo en instalaciones encastradas.

REJILLA CONNECTO B125

La rejilla más resistente combinable con todas las canaletas de la gama CONNECTO®.

NUEVOS MODELOS



Encuétralo en:

Tarifa Edificación y Riego, pág. 12

AMPLIACIÓN DE GAMA



Encuétralo en:

Tarifa Edificación y Riego, pág. 242

NUEVO MODELO

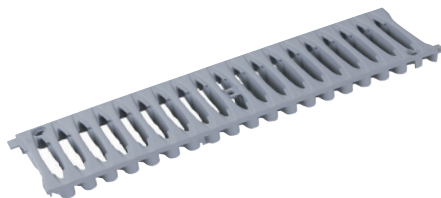

Encuétralo en:

Tarifa Edificación y Riego, pág. 220

¿Qué servicios tenemos para ofrecerte? En Aliaxis somos las personas que cada día te damos repuesta.



Atención comercial al canal de distribución:

Estamos comprometidos a proporcionar apoyo en cada solución, ya que tenemos un equipo de profesionales listos para asesorar al canal de distribución.

El equipo comercial brinda el apoyo necesario sobre todas nuestras categorías de productos y los beneficios que estos brindan.

Solicita un asesor: vozdelcliente@aliaxis.com



Asesoramiento técnico a instaladores:

Ayudamos a instaladores en su día a día y a facilitar la planificación para su negocio. Esto se logra gracias a un **equipo de especialistas en fontanería** encargados de ofrecerles el mejor apoyo técnico.



Prescripción de proyectos de edificación:

Asesoramos a promotoras, constructoras, ingenierías y grandes instaladores en la etapa de desarrollo de sus proyectos para la selección de las mejores soluciones. Utilizamos herramientas avanzadas de diseño para lograr una asesoría personalizada, **contamos con una oficina técnica capaz de realizar cálculos**, diseños y planos como también de optimizar diseños realizados por ingenierías.

Más información: prescripcion.alicante@aliaxis.com



Atención al cliente:

Si alguien puede resolver cualquier duda que se pueda dar durante la compra y/o entrega de un pedido, ese es nuestro equipo de atención al cliente especializado en el canal de distribución.

Pedidos Industria	pedidos.iberia@aliaxis.com
Pedidos Infraestructura	pedidos.infra@aliaxis.com vozdelcliente.infra@aliaxis.com
Pedidos Edificación	pedidos.iberia@aliaxis.com vozdelcliente@aliaxis.com
Teléfono de atención al cliente	965 111 290
Horario de atención al cliente	de Lunes a Jueves: de 8.00 a 17.00 Viernes : de 8.00 a 14.30



SAT:

Contamos con un equipo de expertos que brindan soporte técnico post venta para productos específicos como para depuradoras y trituradores.



Índice

Infraestructura

1 Tubería de PE	7	7 Equipos y herramientas Friatools	75
Tubería para agua	8	Máquinas de soldadura	76
Flexipol PE100 / FM / RD / RC / RT		Rascadores	80
Flexipol PE100 ranurado/perforado		Accesorios y herramientas	85
Excel-Plus			
Tubería para gas	15	8 Accesorios de PE inyectados largos	89
Gasypol PE100 RC			
Tubería para telecomunicaciones y alta tensión		9 Accesorios de PE inyectados cortos	103
2 Magnum 3G	17	10 Accesorios metálicos	113
Fitting para tubo de PE	18	Uniones y adaptadores brida	116
Fitting con inserto de latón	23	Carretes de desmontaje	129
Fitting UTC/PE	24	Abrazaderas de reparación	130
Fitting alta resistencia química HCR	26		
Válvulas para contador HCR	28	11 Válvulas y accesorios de fundición	133
Repuestos	29	Válvulas	134
		Trampillones	137
3 Fitting Astore	31	Accesorios	141
Accesorios en PP para tubería de PE		Ventosas	142
Codos	32	Hidrantes y bocas de riego	144
Máquinas de soldadura	33	Collarines, abrazaderas, tomas en carga	145
Enlaces	34	Bridas	147
Tapones / Llaves de apriete	35		
Collarines	36	12 Accesorios para saneamiento enterrado PVC	149
4 Accesorios manipulados de PE	41		
5 Pasamuros y juntas	53		
6 Accesorios electrosoldables Frialen	57		
Accesorios electrosoldables PE	58		
Tomas simples	68		
Tomas en carga	69		
Válvulas PE para agua y gas	73		

Industria

13 Tubería de PVC-U presión 0802	155	19 Sistema PP-H socket 0805	287
14 Accesorios de PVC-U presión 0801	157	Tubo y accesorios	290
Accesorios encolados, mixtos y roscados		Válvulas manuales	294
Bridas y adaptadores	166	Válvulas actuadas	303
Uniones 3 piezas	173	Válvulas de control de presión	319
Soportes y abrazaderas	175	20 Sistema PP-H testa/butt welding 0805	321
Adhesivos y disolventes	175	Accesorios	324
15 Válvulas manuales de PVC-U presión 0802	177	21 Sistema PVDF 0807	333
Válvulas de bola 2 vías	186	Tubo y accesorios	336
Válvulas de bola 3 vías	191	Válvulas manuales	338
Válvulas de mariposa	192	Válvulas actuadas	345
Válvulas y grifos de membrana	195	Válvulas de control de presión	354
Válvulas de retención	198	22 Sistema C-PVC 0806	357
Filtros inclinados	201	Tubo y accesorios	360
16 Válvulas de solenoide 0904	203	Válvulas manuales	364
17 Válvulas motorizadas de PVC-U presión 0808	207	Válvulas actuadas	371
Válvulas de bola actuadas	212	23 Accesorios mecánicos para la unión de tuberías - Straub 0810	385
Válvula de 3 vías actuadas	216	24 Recambios 0811	437
Válvulas de mariposa	217	Conectores	440
Válvulas de membrana	223	Accesorios para válvulas manuales	441
Válvulas de control de presión	229	Actuadores y accesorios	444
18 Medición 0803	231	Accesorios y válvulas de membrana 0809	448
Flujómetros modelo corto	234	Recambios	452
Flujómetros modelo largo	251		
Medidores electrónicos de caudal	269		
Sensores de caudal	272		
Electrodos de PH y ORP	276		
Sensores y transmisores de conductividad	278		
Accesorios de instalación y recambios	280		

1

2

3

4

5

6

7

8

9

10

11

12

13

14

15

16

17

18

19

20

21

22

23

24



Tubería para agua

Flexipol PE100 / FM / RD / RC / RT
Flexipol PE100 ranurado/perforado
Excel-Plus®

Tubería para gas

Gasypol PE100 RC

Tubería para telecomunicaciones y alta tensión



Tubería de Polietileno

INFRAESTRUCTURA





FLEXIPOL - MASA TUBOS DE POLIETILENO PE100

Conducción de Agua a Presión
Fabricados según Norma UNE-EN 12201

COLOR Y APLICACIONES

Negro Banda Azul: Agua Potable
Negro-Negro Banda Marrón: Agua no Potable (Aguas Industriales-Saneamiento)
Negro Banda Morada: Agua no Potable (Agua Reciclada)

MARCAJE:

MASA FLEXIPOL

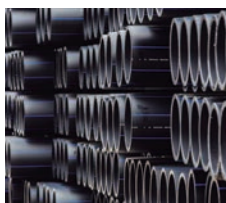

Declaración de cumplimiento Hessel con la PAS 1075 disponible.

FORMATO DE SUMINISTROS*:

Hasta Ø 90 en rollos de 100 metros
Ø 110 en rollos de 50 metros y 100 metros
Desde Ø 20 hasta Ø 110 barras de 6 metros
Desde Ø 90 hasta Ø280 en barras de 12 metros
Desde Ø 315 hasta Ø 1000 en barras de 13 metros

PN10 / SDR 17 Barras

Ref.	Ø Ext.	Long.	Barras /Palet	€/m
059063010116	63	6	131	4,11
059075010116	75	6	100	7,23
059090010116	90	6	63	9,43
059110010116	110	6	60	13,87
059110010115	110	12	60	13,87
059125010116	125	6	45	18,11
059125010115	125	12	45	18,11
059140010115	140	12	39	22,89
059140010116	140	6	39	22,89
059160010115	160	12	28	24,10
059160010116	160	6	28	24,10
059180010115	180	12	22	36,33
059200010115	200	12	6	46,94
059200010116	200	6	6	46,94
059250010115	250	12	5	83,25
059250010116	250	6	5	83,25
059315010113	315	13	4	105,20
059315010116	315	6	4	105,20
059355010113	355	13	3	142,02
059400010113	400	13	3	149,02
059500010113	500	13	2	231,59
059630010113	630	13	2	365,73
059710010113	710	13	2	464,81

PN10 / SDR 17 Rollos

Ref.	Ø Ext.	Long.	Barras /Palet	€/m
059032010125	32	100	-	1,10
059040010125	40	100	-	1,81
059050010125	50	100	-	2,70
059063010125	63	100	-	4,11
059075010124	75	50	-	7,23
059075010125	75	100	-	7,23
059090010125	90	100	-	9,43
059090010124	90	50	-	9,43
059110010124	110	50	-	13,87
059110010125	110	100	-	13,87

PN16 / SDR 11 Barras

Ref.	Ø Ext.	Long.	Barras /Palet	€/m
060040016116	40	6	100	2,64
060050016116	50	6	80	3,98
060063016116	63	6	131	6,01
060075016116	75	6	100	8,22
060090016116	90	6	63	11,63
060110016116	110	6	43	17,12
060110016115	110	12	43	17,12
060125016115	125	12	30	21,95
060125016116	125	6	30	21,95
060160016116	160	6	17	35,62
060160016115	160	12	17	35,62
060200016116	200	6	6	55,31
060200016115	200	12	6	55,31
060225016116	225	6	5	69,57
060250016115	250	12	5	85,80
060250016116	250	6	5	85,80
060315016113	315	13	4	136,50
060315016116	315	6	4	136,50
060400016113	400	13	3	220,10

PN16 / SDR 11 Rollos

Ref.	Ø Ext.	Long.	Barras /Palet	€/m
060020016125	20	100	-	0,83
060025016125	25	100	-	1,01
060032016125	32	100	-	1,59
060040016125	40	100	-	2,64
060050016125	50	100	-	3,98
060063016125	63	100	-	6,01
060075016125	75	100	-	8,22
060075016124	75	50	-	8,22
060090016125	90	100	-	11,63
060090016124	90	50	-	11,63
060110016125	110	100	-	17,12
060110016124	110	50	-	17,12

FLEXIPOL - MASA
TUBOS DE POLIETILENO PE100

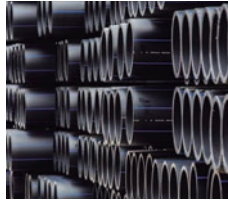

* Para Otros formatos, bandas presiones y aplicaciones se establece una cantidad mínima por pedido.

Ø Medida	Cantidad mínima
	por pedido (m)
20	20000
25	15000
32	10000
40	5000
50	4000
63	2500
75	1500
90	1000
110	1000
125	800
140	500
160	600
180	500
200	400
225	450
250	400
280	450
315	200
355	200
400	150
450	200
500	150
560	200
630	150
710	150
800	100
900	100
1000	100

Ø Medida	C X PALET AGUA	
	PN 10	PN 16
20		250 (metro)
25		200 (metro)
32	150 (metro)	150 (metro)
40	100 (barra)	100 (barra)
50	80 (barra)	80 (barra)
63	131 (barra)	131 (barra)
75	100 (barra)	100 (barra)
90	63 (barra)	63 (barra)
110	60 (barra)	43 (barra)
125	45 (barra)	30 (barra)
140	39 (barra)	26 (barra)
160	28 (barra)	17 (barra)
180	22 (barra)	17 (barra)
200	6 (barra)	6 (barra)
225	5 (barra)	5 (barra)
250	5 (barra)	5 (barra)
280	4 (barra)	4 (barra)
315	4 (barra)	4 (barra)
355	3 (barra)	3 (barra)
400	3 (barra)	3 (barra)
450	2 (barra)	2 (barra)
500	2 (barra)	2 (barra)
560	2 (barra)	2 (barra)
630	2 (barra)	2 (barra)
710	2 (barra)	
800	2 (barra)	
900	1 (barra)	
1000	1 (barra)	

FLEXIPOL - MASA
TUBOS DE POLIETILENO FM

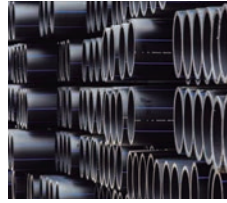

Declaración de cumplimiento Hessel con la PAS 1075 disponible.

Nº Material antiguo	SDR	Medida	Texto breve de material	Importe	UM
A1G0630121F0	SDR9	63	TUBO D 63 FM1613 SDR9 BARRAS 12M	16,75	M
A1G0750121F0	SDR9	75	TUBO D 75 FM1613 SDR9 BARRAS 12M	19,20	M
A1G0900121F0	SDR9	90	TUBO D90 FM1613 SDR9 BARRAS 12M	22,84	M
A1G1100121F0	SDR9	110	TUBO D110 FM1613 SDR9 BARRAS 12M	33,87	M
A1G1250121F0	SDR9	125	TUBO D125 FM1613 SDR9 BARRAS 12M	57,41	M
A1G1400121F0	SDR9	140	TUBO D140 FM1613 SDR9 BARRAS 12M	64,31	M
A1G1600121F0	SDR9	160	TUBO D160 FM1613 SDR9 BARRAS 12M	71,86	M
A1G1800121F0	SDR9	180	TUBO D180 FM1613 SDR9 BARRAS 12M	94,45	M
A1G2000121F0	SDR9	200	TUBO D200 FM1613 SDR9 BARRAS 12M	112,02	M
A1G2250121F0	SDR9	225	TUBO D225 FM1613 SDR9 BARRAS 12M	138,67	M
A1G2501181F0	SDR9	250	TUBO D250 FM1613 SDR9 BARRAS 11,8M	188,21	M
A1G2500121F0	SDR9	250	TUBO D250 FM1613 SDR9 BARRAS 12M	174,38	M
A1G2800121F0	SDR9	280	TUBO D280 FM1613 SDR9 BARRAS 12M	215,22	M
A1G3150121F0	SDR9	315	TUBO D315 FM1613 SDR9 BARRAS 12M	271,61	M
A1F0630121F0	SDR11	63	TUBO D 63 FM1613 SDR11 BARRAS 12M	11,91	M
A1F0750121F0	SDR11	75	TUBO D 75 FM1613 SDR11 BARRAS 12M	15,52	M
A1F0900121F0	SDR11	90	TUBO D90 FM1613 SDR11 BARRAS 12M	19,03	M
A1F1100121F0	SDR11	110	TUBO D110 FM1613 SDR11 BARRAS 12M	28,22	M
A1F1250121F0	SDR11	125	TUBO D125 FM1613 SDR11 BARRAS 12M	41,88	M
A1F1400121F0	SDR11	140	TUBO D140 FM1613 SDR11 BARRAS 12M	53,53	M
A1F1600121F0	SDR11	160	TUBO D160 FM1613 SDR11 BARRAS 12M	59,88	M
A1F1800121F0	SDR11	180	TUBO D180 FM1613 SDR11 BARRAS 12M	79,37	M
A1F2000121F0	SDR11	200	TUBO D200 FM1613 SDR11 BARRAS 12M	93,36	M
A1F2250121F0	SDR11	225	TUBO D225 FM1613 SDR11 BARRAS 12M	115,56	M
A1F2500121F0	SDR11	250	TUBO D250 FM1613 SDR11 BARRAS 12M	145,32	M
A1F2800121F0	SDR11	280	TUBO D280 FM1613 SDR11 BARRAS 12M	179,35	M
A1F3150121F0	SDR11	315	TUBO D315 FM1613 SDR11 BARRAS 12M	226,34	M
A1F3550121F0	SDR11	355	TUBO D355 FM1613 SDR11 BARRAS 12M	285,23	M
A1F4000121F0	SDR11	400	TUBO D400 FM1613 SDR11 BARRAS 12M	359,98	M
A1F4500121F0	SDR11	450	TUBO D450 FM1613 SDR11 BARRAS 12M	454,93	M
A1F5000121F0	SDR11	500	TUBO D500 FM1613 SDR11 BARRAS 12M	562,60	M
A1F5600121F0	SDR11	560	TUBO D560 FM1613 SDR11 BARRAS 12M	699,05	M
A1F6300121F0	SDR11	630	TUBO D630 FM1613 SDR11 BARRAS 12M	898,71	M

FLEXIPOL - MASA - TUBOS DE POLIETILENO PE100 RD

Tubo confeccionado con resina RD de última generación aditivada que le confiere una mayor resistencia a la desinfección realizada en las tuberías de agua potable incluso utilizando Dioxido de Cloro.

Reduce los costes de mantenimiento por ataques químicos. La resina PE-100 RD confiere a la tubería una seguridad 3.5 veces mayor que otras resinas (PEX-b HP, PVC, PE-100 Estándar).

Tubo óptimo para acometidas, donde la influencia de las temperaturas y desinfección afecta más a las instalaciones, y donde el PH del agua es elevado (plantas desaladoras).

Diámetros y espesores conforme a la norma UNE EN-12201 y NF-114 (Francia).



Amplio abanico de certificados disponibles:

ACS de materia prima.

Materia prima certificada por AENOR bajo la UNE EN-12201.

Materia prima homologada por LNE (NF-114) Francia.

Materia prima Certificada por IIP (Istituto Italiano del Plástico) Italia.

Materia prima Certificada por HY (Hygiene-Institut des Ruhrgebiets) Alemania.

FLEXIPOL - TUBOS DE POLIETILENO PE100 RC

Tubo confeccionado con resina RC de última generación que le confiere una mayor resistencia a la propagación lenta y rápida de fisuras y a las cargas puntuales

Cumple con los estrictos requisitos de propagación lenta de fisuras de acuerdo a PAS 1075. Declaración de cumplimiento Hessel disponible.

Ventajas respecto a grados PE 100 Estándar:

Ahorro en costes de obra civil

El tubo puede ser instalado sin lecho de arena

En función del tipo de árido de la excavación éste puede ser reutilizado

Mejor comportamiento en instalaciones "agresivas".

En instalaciones en terrenos con rocas, piedras etc es importante si el tubo sufre arañazos en la instalación.

Es recomendable para nuevas técnicas de entubado sin zanja:

Perforación dirigida, bursting, relining... Donde el tubo sufre abrasión directa

Propiedades Físicas:

Alta resistencia a la propagación lenta de fisuras.

Supera los requisitos estándar del Notched Pipe Test (NPT) según ISO 13479:

Para UNE-EN-1555 > 500h

Para la Asociación PE 100 Plus > 500h

La resina utilizada por MASA > 9.500 h, es decir, superior al año

Supera los requisitos del Full Notch Creep Test (FNCT) Test según ISO 16770:

Para DIBt > 300 h

Para DVGW GW 323 > 3.300 h

La resina utilizada por MASA > 8.760 h, es decir, superior al año

Alta resistencia a la propagación rápida de fisuras.

La resistencia a la propagación rápida de fisuras puede ser medida mediante el Test S4 de acuerdo a la ISO 13477.

La resina utilizada por MASA tiene una alta resistencia en comparación con los requisitos de Ref.:

Para UNE-EN-1555 > 10bar a 0° C

La resina utilizada por MASA alcanza resultados de > 20 bar a -15° C

Amplio abanico de certificados disponibles:

ACS de materia prima y tubo

Materia prima y tubo certificado por AENOR bajo la UNE-

EN-12201 y UNE-EN-1555

Test S4 con diferentes parámetros

Notch Pipe Test > 10.500 h

Point Loading Test > 1 Año

DVGW W270

ISO 9080

Compatibilidad de soldadura

Envejecimiento por calor Hessel: Ensayo superado con 2 Mpa

Resistencia al gas condensado

FLEXIPOL - TUBOS DE POLIETILENO PE100 RT

Tubo fabricado con un polietileno de alta densidad (PE100) negro, que combina las tradicionales cualidades de los tubos de polietileno con nuevas propiedades que amplían sus posibilidades y campo de utilización.

- Resistencia química
- Resistencia a la abrasión.
- Buenas propiedades organolépticas (para su uso con agua potable)
- Buena resistencia a la fluencia
- Posibilidad de unión por termofusión.
- Resistencia a la oxidación
- Buena resistencia a la intemperie

- Alta estabilidad dimensional
- Excelentes propiedades de resistencia al agrietamiento por tensión (ESCR)
- Muy buena resistencia hidrostática a largo plazo, incluso a temperaturas elevadas.
- Excelente envejecimiento al calor
- Alta estabilidad frente a la extracción.

Estas propiedades permiten que este tipo de tubos sean utilizados en nuevas aplicaciones, como son el transporte de agua caliente (a temperaturas superiores a los 40°C admitidos para los tubos PE100), unidades de desalinización ó conductos para cables de potencia.

TUBOS FLEXIPOL PE100 RANURADOS O PERFORADOS PARA EL DRENAJE DE LIXIVIADOS Y CAPTACIÓN DE BIOGÁS

Tubos manipulados a partir de tubos estándar de PE100 según UNE-EN-12201

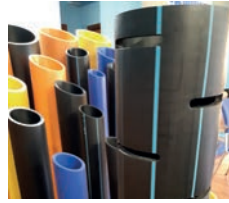

TUBO RANURADO A 1/3, 2/3 O COMPLETO DE ACUERDO A DIN 4266 Y 4262

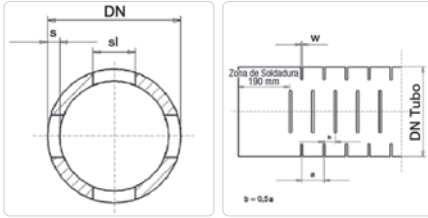

TUBO PERFORADO

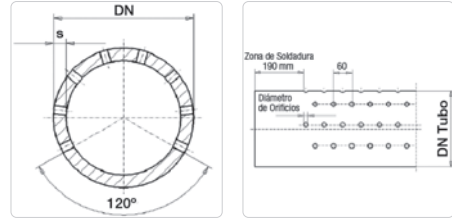

Para medidas solicitar fichas técnicas

TIPOS DE RANURADO

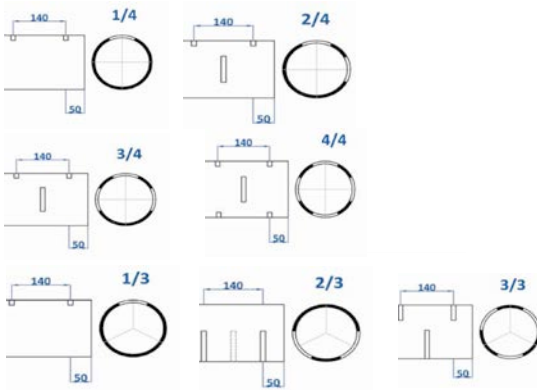

TIPOS DE PERFORACIÓN

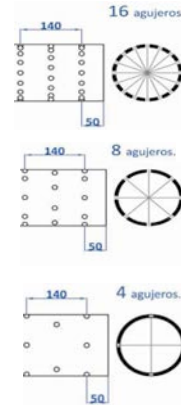

Ø Ext.	PN6	PN10	PN16
63			
75			
90			
110			
125			
140			
160			
180		Consultar	
200			
225			
250			
280			
315			
355			
400			

Ø Ext.	PN6	PN10	PN16
63			
75			
90			
110			
125			
140			
160			
180		Consultar	
200			
225			
250			
280			
315			
355			
400			

Escoger tipo de ranurado, diámetro del tubo y presión.
 Ancho ranura 12 mm.

Escoger tipo de perforación, diámetro del tubo y presión.
 Ø agujero 12 mm

EXCEL-PLUS®

Tubo multicapa para acometidas de agua potable fabricado con PE100 RC y revestimiento interior de PVDF Kynar®. Certificado Sanitario ACS del laboratorio CARSO Laboratoire Santé Environnement Hygiène de Lyon (Francia). Óptimo comportamiento en lugares de desinfección concentrada y alta temperatura.



Resistencia mecánica

El cuerpo en PE100 RC PN16 conforme a norma UNE-EN-12201 dota al tubo de una mayor resistencia mecánica al punzonamiento y a la propagación rápida y lenta de las fisuras. Gran resistencia a los terrenos corrosivos y a la corrosión electrolytica generada por el transporte en ambientes eléctricos.

Insensibilidad a los desinfectantes

El revestimiento interno de PVDF confiere una protección duradera a la oxidación generada por los desinfectantes. Se trata de un polímero caracterizado por una gran resistencia química a los oxidantes en fuerte concentración y temperatura elevada.

Impermeable a hidrocarburos

Sometido al ensayo (WIS 4-32-19) impuesto a los tubos con barrera de aluminio el tubo Excel Plus® demostró su impermeabilidad a los hidrocarburos presentando idénticas prestaciones que estos multicapas tricapa pero con una mayor facilidad de puesta en obra.

Inhibición de biofilm

El revestimiento interno de PVDF Kynar® ralentiza considerablemente la proliferación bacteriana en las paredes del tubo en comparación con un tubo estándar de PE, o un acero, y facilita la eliminación de ese biofilm.

Instalación con accesorios estándar para PE.

Recomendable realizar la unión con accesorios electrosoldables de alta seguridad FRIALEN®

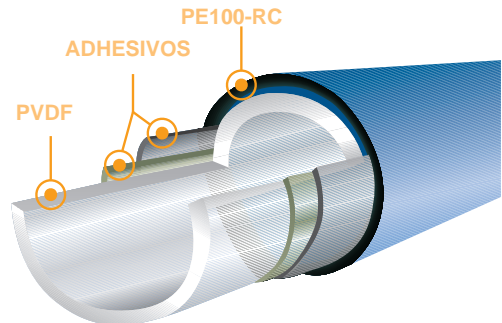

Ø Exterior (mm)	Espesor min. (mm)	Peso (kg/m)	Diámetro rollo 50m (m)	Ancho de rollo (m)	Peso aprox. rollo 50m (kg)	Peso aprox. barra 5m (kg)
25	2,3	0,195	1,20	0,200	10,00	0,98
32	3,0	0,310	1,40	0,200	16,00	1,55
40	3,7	0,469	1,40	0,300	24,00	2,35
50	4,6	0,715	1,70	0,160	36,00	3,58
63	5,8	1,114	1,70	0,260	56,00	5,57
75	6,8	1,542	2,15	0,225	77,11	7,71
90	8,2	2,215	2,50	0,370	110,77	11,08
110	10,0	3,262	-	-	-	16,31



EXCEL-PLUS®

Ref.	Formato	Ø Ext.	Espesor	€/m
X5F0250051M0	Barras 5 mts	25	2,30	10,44
X5F0250502M0	Rollos 50 mts	25	2,30	10,44
X5F0320051M0	Barras 5 mts	32	3,00	13,89
X5F0320502M0	Rollos 50 mts	32	3,00	13,89
X5F0400051M0	Barras 5 mts	40	3,70	19,48
X5F0400502M0	Rollos 50 mts	40	3,70	19,48
X5F0500051M0	Barras 5 mts	50	4,60	22,86
X5F0500502M0	Rollos 50 mts	50	4,60	22,86
X5F0630051M0	Barras 5 mts	63	5,80	30,74
X5F0630502M0	Rollos 50 mts	63	5,80	30,74
X5F0750501M0	Barras 5 mts	75	6,80	41,14
X5F0750502M0	Rollos 50 mts	75	6,80	43,18
X5F0900501M0	Barras 5 mts	90	8,20	51,00
X5F0900502M0	Rollos 50 mts	90	8,20	56,07
X5F1100501M0	Barras 5 mts	110	10,00	65,97

DN	Formato Rollos	Formato Barras
25	Paquetes de 8 rollos (400 metros)	Paquetes de 25 barras (125 metros)
32	Paquetes de 7 rollos (350 metros)	Paquetes de 25 barras (125 metros)
40	Paquetes de 3 rollos (150 metros)	Paquetes de 20 barras (100 metros)
50	Paquetes de 3 rollos (150 metros)	Paquetes de 16 barras (80 metros)
63	Paquetes de 3 rollos (150 metros)	Paquetes de 16 barras (80 metros)
75 a 110	consultar disponibilidad	consultar disponibilidad



SISTEMA DE ACOMETIDA

Set de Acometida	€/ud (Con 1 m de tubo)	€/ud (Con 2 m de tubo)
Set de Acometida DN 25* Toma en carga DAA 63/32 Reducción MR 32/25 Válvula de Bola KH DN 25 Manguito UB DN 25 Tubo Excel Plus DN25	131,80	143,96
Set de Acometida DN 32* Toma en carga DAA 63/32 Manguito UB DN 32 Válvula de Bola KH DN 32 Manguito UB DN 32 Tubo Excel Plus DN32	141,41	157,56

* Consultar precios para otras medidas y/o longitudes de tubo mayores a 1 y 2 m
Los sets se suministran sin soldar. Posibilidad de suministro con soldaduras bajo petición.

**GASYPOL - MASA
 TUBOS DE POLIETILENO
 PE100 RC**

Resistente a la propagación rápida y lenta de fisuras y cargas puntuales

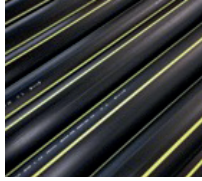

Para Conducción de Combustibles Gaseosos. Fabricados según Norma UNE-EN 1555.
 Declaración de cumplimiento Hessel con la PAS 1075 disponible.

COLORES: negro banda amarilla.

MARCAJE*: MASA GASYPOL
**Personalizados bajo petición*

FORMATO DE SUMINISTROS*

Hasta Ø63 en rollos de 100 metros
 Ø90 y Ø110 (SDR 11) rollos de 50 metros
 Desde Ø110 barras de 8 y 12 metros

**Para otras medidas y SDR consultar la cantidad mínima por pedido en la página 9.*

SDR 11

Ø Ext.	Espesor	€/m
20	3,0	1,71
25	3,0	2,22
32	3,0	2,57
40	3,7	3,84
63	5,8	8,69
90	8,2	17,57
110	10,0	26,06
160	14,6	55,27
200	18,2	86,17
250	22,7	134,14

SDR 17

Ø Ext.	Espesor	€/m
63	3,8	5,93
90	5,4	12,03
110	6,6	17,90
160	9,5	37,40
200	11,9	58,39
250	14,8	90,76
315	18,7	144,41

MONOTUBO POLIETILENO

COLORES

Negro
 Personalizados bajo consulta

FORMATO DE SUMINISTROS

Personalizados: rollos y/o bobinas



Ref.	Ø	€/m
011032	32	3,20
010040	40	4,80
011040	40	5,60
012040	40	5,91
010050	50	4,80
011050	50	6,39
011063	63	6,08



Proveedor global de soluciones en agua y energía

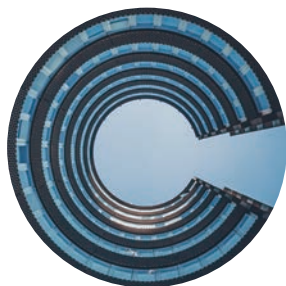

Edificación



Infraestructura



Industria



Agricultura

Trabaja con nuestro equipo de ingenieros y expertos en conducción de fluidos de todo el mundo. Te acompañarán de principio a fin en todos tus proyectos.



0137

Magnum 3G

Sistema para unión de tuberías a presión Magnum 3G

Fitting para tubo de PE

Fitting con inserto de latón

Fitting UTC/PE

Fitting alta resistencia química HCR

Válvulas para contador HCR

Repuestos



Sistema para unión de tuberías a presión

INFRAESTRUCTURA



Más información





Sistema para unión de tuberías a presión Magnum 3G

Fitting para tubo de PE



- **Gama de accesorios de compresión para tuberías de Polietileno** desde 16 hasta 110 mm de diámetro con sistema desliza y aprieta y montaje en sólo 2 pasos.
- **Apto para agua potable y adecuado para el transporte de fluidos a presión** en industria, infraestructura, edificación y agricultura con una fiabilidad total. 1.600Kpa (PN16) a 20oC.
- **Certificaciones de Ø16 a Ø63: KIWA - ACS- AENOR - IIP - DVGW**

kiwa



AENOR
Asociación Española de
Normalización y Certificación



J-63



Medida	Ref.	U/	/ n.º	€
16	M55149	50	A-1	3,15
20	M55017	100	A-11	3,91
25	M55018	100	A-11	4,74
32	M55019	100	A-11	6,75
40	M55020	100	A-9	10,57
50	M55003	100	A-9	15,27
63	M55004	100	A-9	23,02
75	M55021	100	A-11	50,75
90	M55022	100	A-9	65,96
110	M55165	2	A-8	102,45

Enlace recto.

J-68



Medida	Ref.	U/	/ n.º	€
20-16	M55153	50	A-2	3,92
25-16	M55229	50	A-2	4,74
25-20	M55041	50	A-2	4,74
32-20	M55374	25	A-2	7,10
32-25	M55042	25	A-2	6,75
40-25	M55375	25	A-11	13,10
40-32	M55043	25	A-11	10,74
50-25	M55376	15	A-11	17,97
50-32	M55377	15	A-11	17,97
50-40	M55044	15	A-11	20,70
63-32	M55378	15	A-9	21,86
63-40	M55379	15	A-9	21,86
63-50	M55045	15	A-9	28,38
75-63	M55070	5	A-11	50,62
90-75	M55071	5	A-9	68,58
110-90	M55221	2	A-8	99,31

Enlace reducido.

J-95



Medida	Ref.	U/	/ n.º	€
20	M55330	100	A-11	14,90
25	M55331	100	A-9	6,95
32	M55332	50	A-9	8,12
40	M55333	50	A-12	15,10
50	M55334	25	A-4	14,82
63	M55335	20	A-12	27,49

Enlace recto para reparaciones.

J-97



Medida	Ref.	U/	/ n.º	€
32	M55394	50	A-9	10,62
40	M55395	25	A-8	15,06
50	M55396	15	A-9	20,55
63	M55397	15	A-12	27,22

Enlace acodado 45°.



J-64

Medida	Ref.	U/	/ n.º	€
16	M55154	50	A-1	3,15
20	M55029	50	A-2	3,91
25	M55030	50	A-11	4,74
32	M55031	50	A-9	6,98
40	M55032	25	A-8	10,57
50	M55009	15	A-9	15,27
63	M55010	15	A-12	22,98
75	M55033	5	A-9	58,69
90	M55034	5	A-4	68,04
110	M55190	2	A-9	160,66

Enlace acodado 90°.



J-69

Medida	Ref.	U/	/ n.º	€
16-½"	M55312	50	A-2	4,04
20-½"	M55096	50	A-2	3,93
20-¾"	M55313	50	A-2	3,87
25-½"	M55217	50	A-2	4,86
25-¾"	M55097	50	A-2	4,86
25-1"	M55314	50	A-2	4,75
32-¾"	M55315	25	A-2	5,97
32-1"	M55098	25	A-2	6,12
32-1 ¼"	M55316	25	A-2	6,12
40-1"	M55317	25	A-11	7,72
40-1 ¼"	M55099	25	A-11	7,98
50-1 ¼"	M55318	20	A-9	10,67
50-1 ½"	M55163	20	A-9	10,88
50-2"	M55164	20	A-4	16,59

Enlace acodado 90° rosca macho.



J-59

Medida	Ref.	U/	/ n.º	€
63	M55735	10	A-4	34,00

Te 45°.



J-71

SIN REFUERZO METÁLICO

Medida	Ref.	U/	/ n.º	€
16-½"	M55393	50	A-2	3,60
20-½"	M55135	50	A-2	5,09
20-¾"	M55307	50	A-2	5,00
25-½"	M55218	50	A-2	5,94
25-¾"	M55136	50	A-2	5,91
25-1"	M55308	50	A-2	5,80
32-¾"	M55242	25	A-2	7,38
32-1"	M55137	25	A-2	7,38
32-1 ¼"	M55309	25	A-2	8,52
40-1"	M55310	25	A-11	11,89
40-1 ¼"	M55138	25	A-11	9,22
50-1 ¼"	M55311	20	A-9	13,50
50-1 ½"	M55159	20	A-9	13,77
50-2"	M55364	20	A-9	14,73
63-2"	M55160	20	A-4	16,90



J-71

CON REFUERZO METÁLICO

Medida	Ref.	U/	/ n.º	€
20-½"	M55175	50	A-2	5,66
20-¾"	M55366	50	A-2	6,97
25-½"	M55225	50	A-2	6,41
25-¾"	M55176	50	A-2	6,63
25-1"	M55367	50	A-2	6,97
32-¾"	M55243	25	A-2	8,19
32-1"	M55177	25	A-2	8,19
32-1 ¼"	M55368	25	A-2	9,00
40-1"	M55369	25	A-11	12,36
40-1 ¼"	M55178	25	A-11	12,36
50-1 ¼"	M55370	20	A-9	13,96
50-1 ½"	M55188	20	A-9	15,76
50-2"	M55371	20	A-9	15,19
63-2"	M55189	20	A-4	19,45
75-2 ½"	M55257	10	A-9	35,66
90-3"	M55258	6	A-9	48,20
110-4"	M55259	4	A-4	108,61

Enlace acodado 90° rosca hembra..



J-73

Medida	Ref.	U/	/ n.º	€
16	M55150	50	A-2	4,99
20	M55072	100	A-9	5,94
25	M55073	100	A-4	7,15
32	M55074	25	A-8	10,13
40	M55075	25	A-4	15,81
50	M55086	10	A-9	23,06
63	M55087	10	A-4	34,69
75	M55088	5	A-4	86,41
90	M55089	5	A-4	107,68
110	M55191	2	A-4	184,22

Te bocas iguales.



J-74

Medida	Ref.	U/	/ n.º	€
25-20	M55115	50	A-8	11,29
25-32	M55380	50	A-8	10,13
32-25	M55116	25	A-8	13,15
40-25	M55381	25	A-9	15,49
40-32	M55117	25	A-9	15,81
50-25	M55382	10	A-9	24,29
50-32	M55383	10	A-9	24,29
50-40	M55118	10	A-9	24,29
63-25	M55384	10	A-4	28,35
63-32	M55385	10	A-4	32,72
63-50	M55119	10	A-4	34,54

Te 90º reducida al centro



J-96

Medida	Ref.	U/	/ n.º	€
20	M55387	100	A-9	8,62
25	M55388	100	A-4	11,07
32	M55389	25	A-8	14,74
40	M55390	25	A-4	23,96
50	M55391	10	A-9	32,88
63	M55392	10	A-4	44,42

Te 90º para reparaciones.



J-66

Medida	Ref.	U/	/ n.º	€
40-40	M55365	10	A-11	24,87
50-40	M55100	10	A-11	24,87
50-50	M55373	10	A-11	27,27
63-50	M55101	10	A-9	35,21
75-2 1/2"	M55102	5	A-8	40,71
90-3"	M55103	5	A-9	63,11
110-4"	M55222	2	A-11	118,31

Enlace brida.



J-60

Medida	Ref.	U/	/ n.º	€
25-1/2"	M55353	50	A-11	7,24
25-3/4"	M55195	50	A-11	7,38
32-1"	M55196	25	A-11	10,10
40-1 1/4"	M55304	50	A-5	18,52
50-1 1/2"	M55305	15	A-9	23,04
63-2"	M55306	15	A-4	43,34

Te 90º rosca macho.



SIN REFUERZO METÁLICO

J-65

Medida	Ref.	U/	/ n.º	€
16-½"	M55354	100	A-8	4,38
20-½"	M55023	100	A-8	4,99
20-¾"	M55324	100	A-8	6,89
25-½"	M55219	50	A-11	7,04
25-¾"	M55024	100	A-9	7,04
25-1"	M55325	100	A-8	7,43
32-¾"	M55244	50	A-9	9,64
32-1"	M55025	50	A-9	9,64
32-1 ¼"	M55326	50	A-8	10,89
40-1"	M55328	50	A-12	15,24
40-1 ¼"	M55026	50	A-12	15,24
50-1 ¼"	M55329	15	A-9	17,13
50-1 ½"	M55007	15	A-9	18,15
63-2"	M55008	15	A-4	28,49



CON REFUERZO METÁLICO

J-65

Medida	Ref.	U/	/ n.º	€
20-½"	M55183	100	A-8	5,71
20-¾"	M55358	100	A-8	5,75
25-½"	M55224	50	A-11	7,49
25-¾"	M55184	100	A-9	7,69
25-1"	M55359	100	A-9	7,56
32-¾"	M55245	50	A-9	10,38
32-1"	M55185	50	A-9	10,38
32-1 ¼"	M55360	50	A-9	11,59
40-1"	M55362	50	A-4	13,74
40-1 ¼"	M55186	50	A-4	15,50
50-1 ¼"	M55363	15	A-9	17,86
50-1 ½"	M55187	15	A-9	19,45
63-2"	M55141	15	A-4	30,66
75-2 ½"	M55142	5	A-9	73,09
90-3"	M55143	5	A-4	96,55
110-4"	M55227	2	A-4	170,77

Te 90º rosca hembra.



SIN REFUERZO METÁLICO

J-65

Medida	Ref.	U/	/ n.º	€
32-1"-25	M55327	50	A-9	8,16



J-65

CON REFUERZO METÁLICO

Medida	Ref.	U/	/ n.º	€
32-1"-25	M55361	50	A-9	9,46

Te 90º rosca hembra reducida.



SIN REFUERZO METÁLICO

J-72

Medida	Ref.	U/	/ n.º	€
20-½"	M55076	50	A-2	5,26
25-¾"	M55077	50	A-11	5,67



CON REFUERZO METÁLICO

J-72

Medida	Ref.	U/	/ n.º	€
20-½"	M55179	50	A-2	6,44
25-¾"	M55180	50	A-11	7,15

Codo grifo 90º.



J-78

Medida	Ref.	U/	/ n.º	€
16	M55372	50	A-1	2,86
20	M55104	50	A-1	3,15
25	M55105	50	A-2	3,52
32	M55106	25	A-2	5,52
40	M55107	25	A-11	6,80
50	M55108	10	A-2	10,05
63	M55109	10	A-11	14,44
75	M55110	5	A-11	25,73
90	M55111	5	A-8	42,15
110	M55223	2	A-2	85,28

Tapón final.



J-61

Medida	Ref.	U/	/ n.º	€
16-3/8"	M55148	50	A-10	1,97
16-1/2"	M55147	50	A-10	1,97
16-3/4"	M55336	50	A-10	1,94
20-1/2"	M55011	100	A-2	2,42
20-3/4"	M55132	50	A-1	3,34
25-1/2"	M55133	50	A-2	3,34
25-3/4"	M55012	100	A-11	3,03
25-1"	M55213	50	A-2	3,15
32-3/4"	M55214	50	A-11	4,88
32-1"	M55013	100	A-9	4,88
32-1 1/4"	M55215	50	A-11	4,88
32-1 1/2"	M55337	50	A-11	4,79
40-1"	M55216	50	A-9	6,50
40-1 1/4"	M55014	100	A-12	6,50
40-1 1/2"	M55338	100	A-4	7,52
40-2"	M55339	100	A-4	7,52
50-1 1/4"	M55303	25	A-4	8,50
50-1 1/2"	M55001	25	A-8	8,68
50-2"	M55340	25	A-8	10,98
63-1 1/2"	M55341	25	A-4	12,88
63- 2"	M55002	25	A-4	13,13
75-2 1/2"	M55015	5	A-11	33,77
90-3"	M55016	5	A-9	40,01
110-4"	M55192	2	A-11	81,62

Enlace mixto rosca macho.



J-79

Medida	Ref.	U/	/ n.º	€
25-3/4"	M55230	10	A-10	7,38
32-1"	M55231	10	A-1	11,06

Manguito pasamuros.



J-62

SIN REFUERZO METÁLICO

Medida	Ref.	U/	/ n.º	€
16-1/2"	M55152	50	A-10	2,15
20-1/2"	M55035	100	A-2	2,98
20-3/4"	M55687	50	A-1	2,91
20-1"	M55342	100	A-2	2,91
25-1/2"	M55134	50	A-2	3,75
25-3/4"	M55036	100	A-11	3,75
25-1"	M55246	50	A-2	3,75
32-3/4"	M55320	50	A-11	4,89
32-1"	M55037	100	A-9	4,99
32-1 1/4"	M55321	50	A-11	4,89
40-1"	M55322	50	A-9	6,72
40-1 1/4"	M55038	50	A-8	6,84
40-1 1/2"	M55343	50	A-8	6,72
50-1 1/4"	M55323	25	A-8	9,22
50-1 1/2"	M55005	25	A-8	9,22
50-2"	M55344	25	A-8	9,44
63-2"	M55006	25	A-4	14,01



J-62

CON REFUERZO METÁLICO

Medida	Ref.	U/	/ n.º	€
20-1/2"	M55169	100	A-2	3,57
20-3/4"	M55345	50	A-1	3,50
25-1/2"	M55170	50	A-2	4,45
25-3/4"	M55171	100	A-11	4,45
25-1"	M55247	50	A-2	4,45
32-3/4"	M55347	50	A-11	5,65
32-1"	M55172	100	A-9	5,76
32-1 1/4"	M55348	50	A-11	5,65
40-1"	M55349	50	A-8	7,86
40-1 1/4"	M55173	50	A-8	8,02
40-1 1/2"	M55350	50	A-8	8,02
50-1 1/4"	M55351	25	A-8	11,10
50-1 1/2"	M55174	25	A-8	11,31
50-2"	M55352	25	A-8	12,42
63-2"	M55144	25	A-4	16,60
75-2 1/2"	M55145	5	A-11	40,82
90-3"	M55146	5	A-8	109,99
110-4"	M55226	2	A-11	102,90

Enlace mixto rosca hembra.

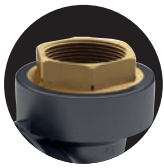
**J-62**

Medida	Ref.	U/	/ n.º	€
20-½"	M55710	50	A-2	18,13
25-¾"	M55711	60	A-11	21,25
32-1"	M55712	50	A-9	24,05
40-1 ¼"	M55713	25	A-2	32,76
50-1 ½"	M55714	12	A-2	40,30
63-2"	M55715	12	A-8	58,54

Enlace mixto rosca hembra con inserto de latón.

**J-71**

Medida	Ref.	U/	/ n.º	€
20-½"	M55723	25	A-2	29,27
25-¾"	M55724	25	A-2	31,85
32-1"	M55725	12	A-1	33,01
40-1 ¼"	M55726	15	A-11	33,01
50-1 ½"	M55727	10	A-11	40,37
63-2"	M55728	10	A-8	50,20

Enlace acodado 90º rosca hembra con inserto de latón.

**J-61**

Medida	Ref.	U/	/ n.º	€
20-½"	M55701	50	A-2	21,24
25-¾"	M55702	60	A-11	21,72
32-¾"	M55703	30	A-11	23,95
32-1"	M55704	50	A-9	23,95
32-1 ¼"	M55705	25	A-11	30,77
32-1 ½"	M55729	25	A-9	30,77
40-1"	M55706	25	A-8	30,94
40-1 ¼"	M55707	40	A-12	32,77
40-1 ½"	M55730	25	A-9	32,76
50-1 ¼"	M55731	12	A-2	40,30
50-1 ½"	M55708	12	A-2	40,30
63-2"	M55709	12	A-8	58,54

Enlace mixto rosca macho con inserto de latón.

**J-69**

Medida	Ref.	U/	/ n.º	€
20-½"	M55716	25	A-2	29,93
25-¾"	M55717	25	A-2	31,67
32-¾"	M55718	12	A-2	34,02
32-1"	M55719	12	A-2	34,02
40- 1"	M55732	12	A-11	37,77
40-1 ¼"	M55720	15	A-11	39,57
40-1 ½"	M55733	15	A-11	39,57
40-1 ¾"	M55734	10	A-2	49,20
50-1 ½"	M55721	10	A-11	49,20
63-2"	M55722	10	A-8	69,65

Enlace acodado 90º rosca macho con inserto de latón.



FITTING UTC/PE

Para la conexión de tubería de PE Métrico a Cobre, PVC, ABS, Acero Inoxidable, Hierro Galvanizado y Plomo

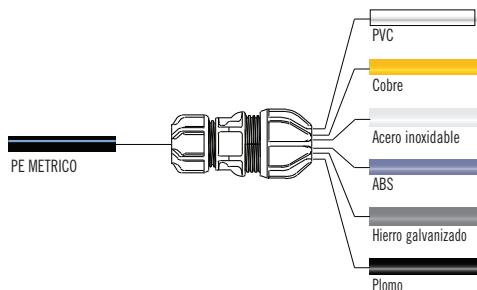

Conexión de PE con una gran variedad de tubos

PVC, cobre, hierro galvanizado, ABS, plomo, acero inoxidable, acero y polietileno.

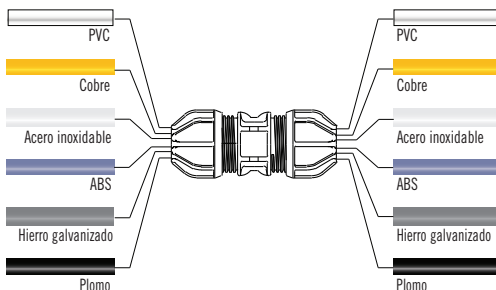

Conexión de una gran variedad de tubos entre sí

PVC, cobre, hierro galvanizado, ABS, plomo, acero inoxidable, acero y polietileno.

INSTALACIÓN RÁPIDA Y FÁCIL - Sistema desliza y aprieta

Completa seguridad

Accesorio premontado, sin riesgo de dañar las tuberías al montar.

Materiales de alto rendimiento

Fabricado con materiales termoplásticos tecnológicamente avanzados.

El Sistema UTC® está clasificado para una presión nominal de 12,5 bar a 20° C..

Cobertura completa

Conectando una amplia variedad de tuberías incluyendo.

Cobre, acero inoxidable, ABS, Hierro galvanizado y plomo.



WATER REGULATIONS ADVISORY SCHEME

WRAS Approval. (United Kingdom)
Cert. n : 1804340

MATERIALES Y COMPONENTES

CONEXIÓN TUBO PE

CONEXIÓN UTC

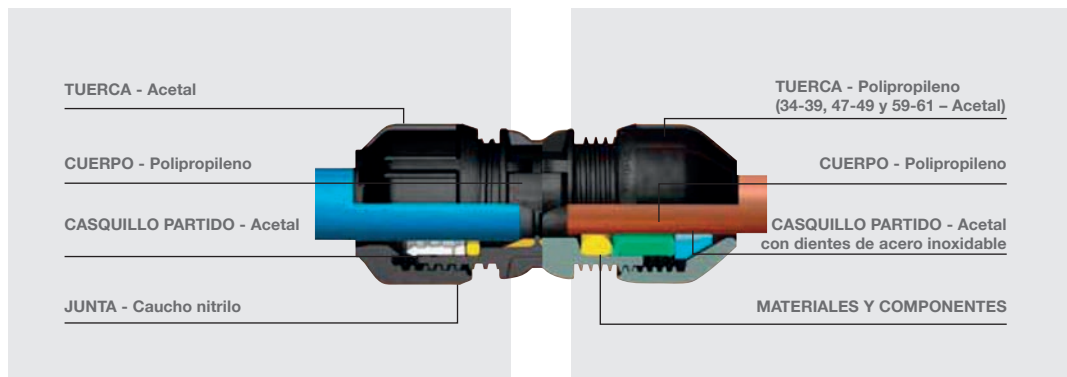



J-63

Medida	Ref.	U/	/ n.º	€
15-21x20	M55453	5	A-10	29,92
21-27x25	M55457	5	A-10	35,76
27-34x32	M55459	5	A-10	50,76
34-39x40	M55462	5	A-10	75,81
47-49x50	M55463	5	A-2	93,06
47-49x63	M55464	5	A-11	106,39
59-61x63	M55465	5	A-2	123,18

Enlace recto transición UTC/PE.



J-61

Medida	Ref.	U/	/ n.º	€
15-21x 3/4"	M55485	5	A-10	108,65
21-27x1"	M55488	5	A-10	119,20
27-34x1 1/2"	M55493	5	A-10	112,61

Enlace mixto r/macho transición UTC/BSP



J-95

Medida	Ref.	U/	/ n.º	€
15-21x15-21	M55471	5	A-10	40,55
21-27x21-27	M55472	5	A-10	44,43
27-34x27-34	M55473	5	A-10	61,98
34-39x34-39	M55474	5	A-10	85,44
39-43x39-43	M55475	5	A-10	97,75
47-49x47-49	M55476	5	A-10	129,70
59-61x59-61	M55477	5	A-10	138,30

Enlace recto reparación UTC/UTC.



J-64

Medida	Ref.	U/	/ n.º	€
21-27x25	M55467	5	A-10	38,01
27-34x32	M55470	5	A-10	28,62

Enlace acodado transición UTC/PE.



J-68

Medida	Ref.	U/	/ n.º	€
21-27x15-21	M55478	5	A-10	44,83
27-34x21-27	M55480	5	A-10	62,57
39-43x27-	M55482	5	A-2	84,87

Enlace reducido reparación UTC/UTC.



J-64

Medida	Ref.	U/	/ n.º	€
21-27x15-21	M55483	5	A-10	30,89
27-34x21-27	M55484	5	A-10	40,92

Enlace acodado UTC/UTC.



MAGNUM 3G

SERIE HCR Sistema para unión de tuberías a presión de alta resistencia a la corrosión.

- Sistema Fácil y rápido de instalar
- Seguro y Fiable
- Avanzado e innovador

Sistema MAGNUM 3G SERIE HCR

La nueva serie HCR Magnum 3G aporta una alternativa eficaz a materiales tradicionales en la instalación de acometidas

para agua potable en edificación e infraestructura, donde materiales como el latón sufren corrosión y deterioro acelerado

debido a los tratamientos para desinfección del agua potable.

Principales características y ventajas del sistema.

Los materiales de la serie HCR MAGNUM 3G están certificados ACS/ AENOR y son aptos para uso en aplicaciones

para agua potable.

- Resistencia química.
- Resistencia a la corrosión y a la abrasión.
- Resistencia a la radiación UV.

Áreas de aplicación.

Los materiales tecnológicamente avanzados confieren al SISTEMA MAGNUM 3G características únicas siendo apto para agua potable y adecuado para el transporte de fluidos a presión en infraestructura, edificación e industria, con una fiabilidad total. 1.600Kpa (PN16) a 20 °C + FOTOS o iconos de los segmentos.

Certificaciones





ACS (Francia),

Fitting materials approved for use in drinking water applications. XP P 41-280. Cert. n. : M3G 15 ACC LY 351 - M3G HCR 15 ACC LY 406.

J-62





Medida	Ref.	U/ 	U/bolsa 	 / n.º	€
20-½"	HCR55035	100	10	A-2	6,15
20-¾"	HCR55687	50	10	A-1	6,15
25-½"	HCR55134	50	10	A-2	6,43
25-¾"	HCR55036	100	10	A-8	6,43
25-1"	HCR55246	50	10	A-2	6,43
32-¾"	HCR55320	50	5	A-11	9,08
32-1"	HCR55037	100	5	A-9	9,08
32-1 ¼"	HCR55321	50	5	A-11	10,95

Enlace mixto rosca hembra HCR.

J-61



Medida	Ref.	U/ 	U/bolsa 	 / n.º	€
20-½"	HCR55011	100	10	A-2	6,00
20-¾"	HCR55132	50	10	A-1	6,00
25-½"	HCR55213	50	10	A-2	6,44
25-¾"	HCR55133	100	10	A-2	6,44
25-1"	HCR55012	50	10	A-8	6,44
32-¾"	HCR55214	50	5	A-11	8,34
32-1"	HCR55013	100	5	A-9	8,34
32-1 ¼"	HCR55215	50	5	A-11	12,22

Enlace mixto rosca macho HCR.



J-65

Medida	Ref.	U/📦	U/bolsa	📦/n.º	€
15-21x20	HCR55024	100	10	A-2	44,48
21-27x25	HCR55244	50	5	A-9	55,11
59-61x63	HCR55025	50	5	A-9	55,11

Te 90º rosca hembra HCR



J-69

Medida	Ref.	U/📦	U/bolsa	📦/n.º	€
25-¾"	HCR55097	50	10	A-2	14,33
25-1"	HCR55314	50	10	A-2	14,33
32-¾"	HCR55315	25	5	A-2	17,20
32-1"	HCR55098	25	5	A-2	17,20

Enlace acodado 90º rosca macho HCR.



J-67

Medida	Ref.	U/📦	U/bolsa	📦/n.º	€
25-¾"	HCR55422	50	10	A-2	7,88
25-1"	HCR55423	50	10	A-2	8,52
32-¾"	HCR55424	25	5	A-2	8,70
32-1"	HCR55425	25	5	A-2	9,65

Enlace mixto rosca hembra, con tuerca loca HCR.



J-99

Medida	Ref.	U/📦	U/bolsa	📦/n.º	€
25-¾"	HCR55413	50	10	A-2	22,71
25-1"	HCR55414	50	10	A-2	22,71
32-¾"	HCR55415	25	5	A-2	26,50
32-1"	HCR55416	25	5	A-2	26,50

Enlace acodado 90ºrosca hembra, con tuerca loca HCR.



J-72

Medida	Ref.	U/📦	U/bolsa	📦/n.º	€
25-¾"	HCR55077	50	10	A-11	43,16

Codo grifo 90º HCR.



Medida	Ref.	U/	/ n.º	€
20-3/4"	52330	50	A-11	34,20
25-3/4"	52331	50	A-11	35,18
32-3/4"	52332	50	A-8	41,24

Válvula esfera para contador - HCR. Enlace fitting.



Medida	Ref.	U/	/ n.º	€
1/2"-3/4"	52333	50	A-11	33,09
3/4"-3/4"	52334	50	A-11	33,53
1"-3/4"	52335	50	A-11	38,28

Válvula esfera para contador - HCR. Conexión rosca macho



Medida	Ref.	U/	/ n.º	€
25-3/4"	52336	50	A-11	47,29
32-3/4"	52337	50	A-8	55,63

Válvula esfera ángulo para contador - HCR. Enlace fitting.



Medida	Ref.	U/	/ n.º	€
3/4"-3/4"	52338	50	A-11	33,53
1"-3/4"	52339	50	A-11	38,28

Válvula esfera ángulo para contador - HCR. Conexión rosca macho.



Medida	Ref.	U/	/ n.º	€
16	M55157	50	4115	0,50
20	M55052	50	4115	0,59
25	M55053	50	4115	0,65
32	M55054	50	A-10	1,06
40	M55055	50	A-10	1,47
50	M55056	25	A-10	1,80
63	M55057	25	A-10	2,59

Junta de estanqueidad Magnum 3G y Magnum 3G-HCR.



Medida	Ref.	U/	/ n.º	€
20	M55400	50	A-2	0,58
25	M55401	50	A-2	0,64
32	M55402	50	A-2	1,05
40	M55403	50	A-2	1,44
50	M55056	25	A-10	1,80
63	M55057	25	A-10	2,59

Junta de estanqueidad accesorios reparaciones Magnum 3G.



Medida	Ref.	U/	/ n.º	€
16	M55232	50	A-10	0,63
20	M55233	50	A-10	0,66
25	M55234	50	A-1	0,71
32	M55235	50	A-2	1,14
40	M55236	50	A-11	1,94
50	M55237	25	A-11	3,11
63	M55238	25	A-8	5,41

Racor Magnum 3G.



Medida	Ref.	U/	/ n.º	€
20	HCR55233	50	A-10	0,86
25	HCR55234	50	A-10	1,03
32	HCR55235	50	A-2	1,31

Racor Magnum 3G - HCR.



Medida	Ref.	U/	/ n.º	€
16	M55156	50	A-10	0,50
20	M55046	50	A-10	0,59
25	M55047	50	A-10	0,81
32	M55048	50	A-10	0,93
40	M55049	50	A-10	1,07
50	M55050	25	A-10	1,50
63	M55051	25	A-1	1,62
75	M55064	15	A-1	14,30
90	M55065	15	A-2	18,84
110	M55168	15	A-2	28,00

Casquillo partido Magnum 3G.





Medida	Ref.	U/	/ n.º	€
16	HCR55046	50	4115	0,58
20	HCR55047	50	4115	0,79
63	HCR55048	50	A-10	0,91

Casquillo partido Magnum 3G - HCR.

Medida	Ref.	U/	/ n.º	€
20	M55406	20	A-10	3,67
25	M55407	20	A-10	3,71
32	M55408	20	A-10	4,78
40	M55409	10	A-10	5,41
50	M55410	10	A-10	6,79
63	M55411	10	A-1	11,61



Casquillo partido Magnum 3G especial tubo PVC.



Medida	Ref.	U/ 	 / n.º	€
16-32	055248	20	A-10	40,94
40-63	055249	20	A-2	57,54
75-110	055250	10	A-8	114,34

Llave de apriete fitting Gama'55.



Medida	Ref.	U/ 	 / n.º	€
16 a 63	055690 ●	10	A-2	22,90

Llave de apriete fitting universal.

0940
Accesorios en PP para tubería de PE

Codos

Máquinas de soldadura

Enlaces

Tapones / Llaves de apriete

Collarines

0802
Válvulas manuales de PVC-U presión

Válvulas de bola 2 vías



Fitting Astore





513

d	Ref.	PN	U/	€
16	GG51316000	16	360	1,41
20	GG51320000 ●	16	200	1,64
25	GG51325000 ●	16	150	2,10
32	GG51332000 ●	16	80	2,92
40	GG51340000 ●	16	50	4,54
50	GG51350000 ●	16	30	7,34
63	GG51363000 ●	16	15	11,48
75	GR51375000 ●	10	11	15,47
90	GR51390000 ●	10	8	21,25
110	GR51311000 ●	10	4	27,84

Codo 90°
H-H



519

d x Rh	Ref.	PN	2	€
16 x 1/2"	GG51916B00	16	400	1,01
20 x 1/2"	GG51920B00 ●	16	260	1,04
20 x 3/4"	GG51920C00	16	260	1,24
25 x 1/2"	GG51925B00	16	180	1,77
25 x 3/4"	GG51925C00 ●	16	180	1,57
25 x 1"	GG51925D00	16	180	1,57
32 x 1"	GG51932D00 ●	16	110	2,00
32 x 1 1/4"	GG51932E00	16	110	1,82
40 x 1 1/4"	GG51940E00 ●	16	60	3,74
40 x 1 1/2"	GG51940F00	16	60	3,69
50 x 1 1/2"	GG51950F00 ●	16	35	5,53
50 x 2"	GG51950G00	16	35	5,59
63 x 2"	GG51963G00 ●	16	20	7,51
63 x 2 1/2"	GG51963H00	16	20	7,89
75 x 2 1/2"	GR51975H00	10	14	10,05
75 x 3"	GR51975I00	10	14	10,16
90 x 3"	GR51990I00 ●	10	10	15,29
110 x 4"	GR51911L00	10	5	19,43

Codo 90° rosca macho.
H-M



518

d x Rh	Ref.	PN	U/	€
16 x 3/8"	GG51816A00	16	400	1,94
16 x 1/2"	GG51816B00	16	400	2,56
20 x 1/2"	GG51820B00 ●	16	260	1,94
20 x 3/4"	GG51820C00	16	260	2,63
25 x 1/2"	GG51825B00	16	180	2,83
25 x 3/4"	GG51825C00 ●	16	180	2,95
25 x 1"	GG51825D00	16	160	2,95
32 x 1/2"	GG51832B00 ●	16	110	3,60
32 x 3/4"	GG51832C00 ●	16	110	3,60
32 x 1"	GG51832D00 ●	16	110	3,60
32 x 1 1/4"	GG51832E00	16	60	4,16
40 x 1 1/4"	GG51840E00 ●	16	60	6,11
40 x 1 1/2"	GG51840F00	16	60	6,11
50 x 1/2"	GG51850F00 ●	16	35	6,94
50 x 2"	GG51850G00	16	35	7,17
63 x 2"	GG51863G00 ●	16	20	11,04
63 x 2 1/2"	GG51863H00	16	20	11,68
75 x 2 1/2"	GR51875H00 ●	16	14	12,44
75 x 3"	GR51875I00	10	14	13,44
90 x 3"	GR51890I00 ●	10	10	17,09
110 x 4"	GR51811L00	10	5	21,07

Codo 90°
H-H



524

d x Rh	Ref.	PN	U/	€
25 x 3/4"	GG52425C00	16	150	2,86

Codo grifo 90°.
H-H

Las piezas rosca hembra de diámetro 40 mm o superior llevan anillo de refuerzo en acero inox.



514



d	Ref.	PN	U/	€
16	GG51416000	16	220	1,94
20	GG51420000	16	120	2,40
20-25-20	GG51420C00	16	120	2,83
25	GG51425000	16	90	2,92
25-32-25	GG51425D00	16	70	4,96
32	GG51432000	16	50	4,20
40	GG51440000	16	30	6,50
50	GG51450000	16	20	10,21
63	GG51463000	16	12	15,68
75	GR51475000	10	7	25,81
90	GR51490000	10	5	30,37
110	GR51411000	10	3	42,21

Te a 90°
H-H-H



516

d x Rm X d	Ref.	PN	U/	€
16 x 1/2" x 16	GG51616B00	16	240	1,43
20 x 1/2" x 20	GG51620B00	16	140	1,61
20 x 3/4" x 20	GG51620C00	16	140	1,88
25 x 3/4" x 25	GG51625C00	16	100	2,95
25 x 1" x 25	GG51625D00	16	100	3,14
32 x 1" x 32	GG51632D00	16	60	3,33
32 x 1 1/4" x 32	GG51632D00	16	60	3,33
40 x 1 1/4" x 40	GG51640E00	16	30	6,31
40 x 1 1/2" x 40	GG51640F00	16	30	6,24
50 x 1 1/2" x 50	GG51650F00	16	20	9,23
50 x 2" x 50	GG51650G00	16	20	9,61
63 x 2" x 63	GG51663G00	16	12	11,42
63 x 2 1/2" x 63	GG51663H00	16	12	11,42
75 x 2 1/2" x 75	GR51675H00	10	10	15,72
90 x 3" x 90	GR51690I00	10	6	23,91
110 x 4" x 110	GR51611L00	10	3	32,20

Te a 90° rosca macho igual y reducida.
H-M-H

515



d x Rh X d	Ref.	PN	U/	€
16 x 3/8" x 16	GG51516A00	16	240	2,88
16 x 1/2" x 16	GG51516B00	16	240	2,72
20 x 1/2" x 20	GG51520B00	16	140	2,92
20 x 3/4" x 20	GG51520C00	16	140	2,92
25 x 1/2" x 25	GG51525B00	16	100	3,10
25 x 3/4" x 25	GG51525C00	16	100	3,10
25 x 1" x 25	GG51525D00	16	100	3,63
32 x 1/2" x 32	GG51532B00	16	60	3,74
32 x 3/4" x 32	GG51532C00	16	60	3,74
32 x 1" x 32	GG51532D00	16	60	3,74
32 x 1 1/4" x 32	GG51532E00	16	50	4,74
40 x 1" x 40	GG51540D00	16	30	6,06
40 x 1 1/4" x 40	GG51540E00	16	30	5,70
40 x 1 1/2" x 40	GG51540F00	16	30	6,13
50 x 1 1/2" x 50	GG51550F00	16	20	9,40
50 x 2" x 50	GG51550G00	16	20	11,46
63 x 2" x 63	GG51563G00	16	12	13,08
63 x 2 1/2" x 63	GG51563H00	16	12	13,08
75 x 2 1/2" x 75	GR51575H00	10	10	19,79
90 x 3" x 90	GR51590I00	10	6	25,70
110 x 4" x 110	GR51511L00	10	3	33,29

Te a 90° rosca hembra igual y reducida.
H-H-H



523

d x dr x d	Ref.	PN	U/	€
25 x 20 x 25	GG52325B00	16	100	3,39
32 x 25 x 32	GG52332C00	16	60	3,47
40 x 32 x 40	GG52340D00	16	30	7,44
50 x 40 x 50	GG52350E00	16	20	10,37
63 x 50 x 63	GG52363F00	16	12	13,92

Te a 90° reducida en el centro.
H-H-H



Enlaces

510



d	Ref.	PN	U/☒	€
16	GG51016000	16	360	1,31
20	GG51020000 ●	16	200	1,59
25	GG51025000 ●	16	150	1,94
32	GG51032000 ●	16	80	2,52
40	GG51040000 ●	16	50	4,28
50	GG51050000 ●	16	30	6,94
63	GG51063000 ●	16	15	10,35
75	GR51075000 ●	10	11	12,04
90	GR51090000 ●	10	8	17,71
110	GR51011000 ●	10	4	23,46

Enlace recto.

H-H



601

d x Rm	Ref.	PN	U/☒	€
16 x 3/8"	GG60116A00	16	500	1,79
16 x 1/2"	GG60116B00	16	500	1,77
20 x 1/2"	GG60120B00 ●	16	400	1,35
20 x 3/4"	GG60120C00	16	340	1,35
25 x 1/2"	GG60125B00	16	250	1,83
25 x 3/4"	GG60125C00 ●	16	250	1,81
25 x 1"	GG60125D00	16	200	1,87
32 x 1/2"	GG60132B00	16	150	1,96
32 x 3/4"	GG60132C00 ●	16	150	1,96
32 x 1"	GG60132D00 ●	16	150	1,92
32 x 1 1/4"	GG60132E00	16	130	2,88
40 x 1"	GG60140D00	16	90	3,87
40 x 1 1/4"	GG60140E00 ●	16	90	5,16
40 x 1 1/2"	GG60140F00 ●	16	90	5,16
50 x 1 1/4"	GG60150E00	16	55	6,00
50 x 1 1/2"	GG60150F00 ●	16	55	6,00
50 x 2"	GG60150G00	16	55	6,88
63 x 1 1/2"	GG60163F00	16	30	7,24
63 x 2"	GG60163G00 ●	16	30	7,08
75 x 2"	GR60175G00	10	25	9,34
75 x 2 1/2"	GR60175H00 ●	10	25	9,89
75 x 3"	GR60175I00	10	25	10,04
90 x 2"	GR60190G00	10	16	11,62
90 x 2 1/2"	GR60190H00	10	16	12,55
90 x 3"	GR60190I00 ●	10	16	11,84
110 x 3"	GG60111I00	10	8	19,85
110 x 4"	GR60111L00	10	8	22,38

Enlace rosca hembra.

H-M.

511



d x Rm	Ref.	PN	U/☒	€
16 x 3/8"	GG51116A00	16	500	0,93
16 x 1/2"	GG51116B00 ●	16	500	0,79
16 x 3/4"	GG51116C00	16	500	0,84
20 x 1/2"	GG51120B00 ●	16	400	1,03
20 x 3/4"	GG51120C00	16	400	1,03
25 x 1/2"	GG51125B00	16	250	1,17
25 x 3/4"	GG51125C00 ●	16	250	1,17
25 x 1"	GG51125D00	16	250	1,42
32 x 3/4"	GG51132C00 ●	16	150	1,74
32 x 1"	GG51132D00 ●	16	150	1,74
32 x 1 1/4"	GG51132E00 ●	16	150	2,28
40 x 1"	GG51140D00 ●	16	90	2,46
40 x 1 1/4"	GG51140E00 ●	16	90	2,74
40 x 1 1/2"	GG51140F00 ●	16	90	2,74
50 x 1 1/4"	GG51150E00	16	55	4,33
50 x 1 1/2"	GG51150F00 ●	16	55	4,33
50 x 2"	GG51150G00 ●	16	55	4,58
63 x 1 1/2"	GG51163F00	16	30	5,25
63 x 2"	GG51163G00 ●	16	30	6,66
63 x 2 1/2"	GG51163H00	16	30	6,66
75 x 2"	GR51175G00	10	25	7,79
75 x 2 1/2"	GR51175H00 ●	10	25	8,01
75 x 3"	GR51175I00	10	25	9,30
90 x 2"	GR51190G00	10	16	10,55
90 x 2 1/2"	GR51190H00	10	16	10,55
90 x 3"	GR51190I00 ●	10	16	11,74
90 x 4"	GR51190L00	10	16	12,98
110 x 2"	GG51111G00	10	8	16,02
110 x 3"	GR51111I00	10	8	16,69
110 x 4"	GR51111L00 ●	10	8	18,72

Enlace rosca macho.

H-M.



Accesorios en PP para tubería de PE

Tapones / Llaves de apriete

525



d x Rh	Ref.	PN	U/	€
25 x 1"	GG52525D00	16	200	3,96
32 x 1"	GG52532D00	16	140	4,43

Enlace con tuerca.
H-H

512



d x dr	Ref.	PN	U/	€
20 x 16	GG51220A00	16	260	1,61
25 x 20	GG51225B00	16	180	1,94
32 x 20	GG51232B00	16	110	2,23
32 x 25	GG51232C00	16	110	2,28
40 x 25	GG51240C00	16	70	3,87
40 x 32	GG51240D00	16	70	4,28
50 x 25	GG51250C00	16	40	4,58
50 x 32	GG51250D00	16	40	4,60
50 x 40	GG51250E00	16	40	5,14
63 x 32	GG51263D00	16	25	6,37
63 x 40	GG51263E00	16	25	6,37
63 x 50	GG51263F00	16	20	6,50
75 x 50	GR51275F00	10	15	8,92
75 x 63	GR51275G00	10	15	8,92
90 x 63	GR51290G00	10	12	13,59
90 x 75	GR51290H00	10	12	14,92
110 x 75	GG51211H00	10	6	21,77
110 x 90	GR51211I00	10	6	25,75

Enlace reducido.
H-H.

520



d x DN	Ref.	PN	U/	€
50 x 1½"	GG52050F00	12	-	23,77
63 x 2"	GG52063G00	10	-	23,31
75 x 2½"	GR52075H00	10	5	25,08
75 x 3" (A)	GR52075I00	10	6	25,00
90 x 3"	GR52090I00	10	3	26,69
90 x 4" (A)	GR52090L00	10	3	27,78
110 x 4"	GR52011L00	10	2	33,40

Enlace con brida metálica.
H-Brida

521



d	Ref.	PN	U/	€
16	GG52116000	16	500	1,01
20	GG52120000	16	400	1,27
25	GG52125000	16	250	1,44
32	GG52132000	16	150	2,28
40	GG52140000	16	90	2,81
50	GG52150000	16	60	4,42
63	GG52163000	16	30	6,66
75	GR52175000	10	28	7,70
90	GR52190000	10	22	10,43
110	GR52111000	10	8	13,66

Tapón final.
H.

J-93



Medida	Ref.	U/	/ n.º	€
16 a 63	055690	10	A-2	22,90

Llave de apriete fitting universal.



Collarines



503

d x Rh	Ref.	PN	U/	€
20 x 1/2"	503020012	10	150	1,06
25 x 1/2"	503025012	10	120	1,06
25 x 3/4"	503025034	10	120	1,06
32 x 1/2"	503032012 ●	10	100	1,06
32 x 3/4"	503032034	10	100	1,06
32 x 1"	503032100	10	60	1,32
40 x 1/2"	503040012	10	60	1,32
40 x 3/4"	503040034	10	60	1,32
40 x 1"	503040100	10	60	1,32
50 x 1/2"	503050012	10	50	1,56
50 x 3/4"	503050034	10	50	1,56
50 x 1"	503050100	10	50	1,56
63 x 1/2"	503063012 ●	10	75	2,28
63 x 3/4"	503063034	10	75	2,28
63 x 1"	503063100	10	75	2,28
63 x 1 1/4"	503063114	10	70	2,28
63 x 1 1/2"	503063112	10	70	2,28
75 x 1/2"	503075012	10	50	3,56
75 x 3/4"	503075034	10	50	3,56
75 x 1"	503075100	10	50	3,56
75 x 1 1/4"	503075114	10	45	3,56
75 x 1 1/2"	503075112	10	45	3,56
75 x 2"	503075200	10	45	3,56

d x Rh	Ref.	PN	U/	€
90 x 1/2"	503090012	10	40	4,20
90 x 3/4"	503090034	10	40	4,20
90 x 1"	503090100	10	40	4,20
90 x 1 1/4"	503090114	10	35	4,20
90 x 1 1/2"	503090112	10	35	4,20
90 x 2"	503090200	10	35	4,20
110 x 1/2"	503110012	10	25	4,98
110 x 3/4"	503110034	10	25	4,98
110 x 1"	503110100	10	25	4,98
110 x 1 1/4"	503110114	10	25	4,98
110 x 1 1/2"	503110112	10	25	4,98
110 x 2"	503110200	10	25	4,98
110 x 3"	503110300	10	20	11,58

Collarín en PP sin refuerzo.

Para riego y obra civil.



505

d x Rh	Ref.	PN	U/	€NBR
20 x 1/2"	505020012	10	150	1,76
25 x 1/2"	505025012	10	120	1,82
25 x 3/4"	505025034	10	120	1,82
32 x 1/2"	505032012	10	100	2,00
32 x 3/4"	505032034	10	100	2,00
32 x 1"	505032100	10	60	2,08
40 x 1/2"	505040012	10	60	2,14
40 x 3/4"	505040034	10	60	2,14
40 x 1"	505040100	10	60	2,14
50 x 1/2"	505050012	10	50	2,28
50 x 3/4"	505050034	10	50	2,28
50 x 1"	505050100	10	75	2,28
63 x 1/2"	505063012	10	75	2,98
63 x 3/4"	505063034	10	75	2,98
63 x 1"	505063100	10	70	2,98
63 x 1 1/4"	505063114	10	70	2,98
63 x 1 1/2"	505063112	10	50	2,98
75 x 1/2"	505075012	10	50	3,80
75 x 3/4"	505075034	10	50	3,80
75 x 1"	505075100	10	45	3,80
75 x 1 1/4"	505075114	10	45	3,80
75 x 1 1/2"	505075112	10	45	3,80
75 x 2"	505075200	10	40	3,80
90 x 1/2"	505090012	10	40	4,32
90 x 3/4"	505090034	10	40	4,32
90 x 1"	505090100	10	35	4,32
90 x 1 1/4"	505090114	10	35	4,32
90 x 1 1/2"	505090112	10	25	4,32
90 x 2"	505090200	10	25	4,32
110 x 1/2"	505110012	10	25	5,10
110 x 3/4"	505110034	10	25	5,10
110 x 1"	505110100	10	25	5,10
110 x 1 1/4"	505110114	10	25	5,10
110 x 1 1/2"	505110112	10	25	5,10
110 x 2"	505110200	10	25	5,10
110 x 3"	505110300	10	20	10,80
125 x 3/4"	505125034	10	30	7,92
125 x 1"	505125100	10	30	7,92
125 x 1 1/4"	505125114	10	30	7,92
125 x 1 1/2"	505125112	10	30	7,92
125 x 2"	505125200	10	30	7,92

d x Rh	Ref.	PN	U/	€NBR
140 x 1"	505140100	10	20	10,30
140 x 1 1/4"	505140114	10	20	10,30
140 x 1 1/2"	505140112	10	20	10,30
140 x 2"	505140200	10	20	10,30
140 x 2 1/2"	505140212	6	20	14,36
140 x 3"	505140300	10	20	14,36
160 x 3/4"	505160034	10	16	14,50
160 x 1"	505160100	10	16	14,50
160 x 1 1/4"	505160114	10	16	14,50
160 x 1 1/2"	505160112	10	16	14,50
160 x 2"	505160200	10	16	14,50
160 x 3"	505160300	6	15	20,70
180 x 1 1/4"	505180114	6	8	54,90
180 x 1 1/2"	505180112	6	8	54,90
180 x 2"	505180200	6	8	54,90
180 x 3"	505180300	6	8	54,90
180 x 4"	505180400	6	6	54,90
200 x 1 1/4"	505200114	6	8	57,30
200 x 1 1/2"	505200112	6	8	57,30
200 x 2"	505200200	6	8	57,30
200 x 3"	505200300	6	8	58,84
200 x 4"	505200400	6	8	58,84
225 x 1 1/4"	505225114	4	7	68,52
225 x 1 1/2"	505225112	4	7	68,52
225 x 2"	505225200	4	7	68,52
225 x 3"	505225300	4	7	68,52
225 x 4"	505225400	4	7	71,10
250 x 1 1/4"	505250114	4	7	80,80
250 x 1 1/2"	505250112	4	7	80,80
250 x 2"	505250200	4	7	80,80
250 x 3"	505250300	4	7	82,74
250 x 4"	505250400	4	6	82,74
280 x 1 1/4"	505280114	4	3	98,64
280 x 1 1/2"	505280112	4	3	98,64
280 x 2"	505280200	4	3	98,64
280 x 3"	505280300	4	3	98,64
280 x 4"	505280400	4	3	98,64
315 x 1 1/4"	505315114	4	4	101,48
315 x 1 1/2"	505315112	4	4	101,48
315 x 2"	505315200	4	4	101,48
315 x 3"	505315300	4	4	105,36
315 x 4"	505315400	4	4	105,36

Collarín en PP con anillo de refuerzo en inox.
Para riego y obra civil.



508

d x Rh x Rh	Ref.	€NBR
20 x 1/2" x 1/2"	508020012	2,98
25 x 1/2" x 1/2"	508025012	3,20
25 x 3/4" x 3/4"	508025034	3,20
32 x 1/2" x 1/2"	508032012	3,96
32 x 3/4" x 3/4"	508032034	3,96
32 x 1" x 1"	508032100	4,08
40 x 1/2" x 1/2"	508040012	4,66
40 x 3/4" x 3/4"	508040034	4,66
40 x 1" x 1"	508040100	4,66
50 x 1/2" x 1/2"	508050012	5,14
50 x 3/4" x 3/4"	508050034	5,14
50 x 1" x 1"	508050100	5,14
63 x 1/2" x 1/2"	508063012	6,18
63 x 3/4" x 3/4"	508063034	6,18
63 x 1" x 1"	508063100	6,18
63 x 1 1/4" x 1 1/4"	508063114	6,18
63 x 1 1/2" x 1 1/2"	508063112	6,18
75 x 1/2" x 1/2"	508075012	8,12
75 x 3/4" x 3/4"	508075034	8,12
75 x 1" x 1"	508075100	8,12
75 x 1 1/4" x 1 1/4"	508075114	8,12
75 x 1 1/2" x 1 1/2"	508075112	8,12
75 x 2" x 2"	508075200	8,12
90 x 1/2" x 1/2"	508090012	10,88
90 x 3/4" x 3/4"	508090034	10,88
90 x 1" x 1"	508090100	10,88
90 x 1 1/4" x 1 1/4"	508090114	10,88
90 x 1 1/2" x 1 1/2"	508090112	10,88
90 x 2" x 2"	508090200	10,88
110 x 1/2" x 1/2"	508110012	11,70
110 x 3/4" x 3/4"	508110034	11,70
110 x 1" x 1"	508110100	11,70
110 x 1 1/4" x 1 1/4"	508110114	11,70
110 x 1 1/2" x 1 1/2"	508110112	11,70
110 x 2" x 2"	508110200	11,70
110 x 3" x 3"	508110300	27,44

d x Rh x Rh	Ref.	€NBR
125 x 3/4" x 3/4"	508125034	16,68
125 x 1" x 1"	508125100	16,68
125 x 1 1/4" x 1 1/4"	508125114	16,68
125 x 1 1/2" x 1 1/2"	508125112	16,68
125 x 2" x 2"	508125200	16,68
140 x 1"	508140100	21,86
140 x 1 1/4"	508140114	21,86
140 x 1 1/2"	508140112	21,86
140 x 2"	508140200	21,86
140 x 2 1/2"	508140212	28,06
140 x 3"	508140300	28,06
160 x 1" x 1"	508160100	28,98
160 x 1 1/4" x 1 1/4"	508160114	28,98
160 x 1 1/2" x 1 1/2"	508160112	28,98
160 x 2" x 2"	508160200	28,98
160 x 3" x 3"	508160300	39,46
180 x 1 1/4" x 1 1/4"	508180114	119,10
180 x 2" x 2"	508180200	119,10
200 x 1 1/4" x 1 1/4"	508200114	108,16
200 x 1 1/2" x 1 1/2"	508200112	108,16
200 x 2" x 2"	508200200	108,16
200 x 3" x 3"	508200300	113,52
200 x 4" x 4"	508200400	113,52
225 x 1 1/4" x 1 1/4"	508225114	123,82
225 x 1 1/2" x 1 1/2"	508225112	123,82
225 x 2" x 2"	508225200	123,82
225 x 3" x 3"	508225300	132,30
225 x 4" x 4"	508225400	132,30
250 x 1 1/4" x 1 1/4"	508250114	169,66
250 x 1 1/2" x 1 1/2"	508250112	169,66
250 x 2" x 2"	508250200	169,66
250 x 3" x 3"	508250300	178,14
250 x 4" x 4"	508250400	178,14
315 x 1 1/4" x 1 1/4"	508315114	226,60
315 x 1 1/2" x 1 1/2"	508315112	226,60
315 x 2" x 2"	508315200	226,60
315 x 3" x 3"	508315300	236,12
315 x 4" x 4"	508315400	236,12

Collarín en PP con anillo de refuerzo en inox.
Para riego y obra civil.



Válvulas manuales de PVC-U presión

Válvulas de bola 2 vías



420*

d	Ref.	DN	PN	U/	€ EPDM
16	1V42001600	10	16	90	9,33
20	1V42002000 ●	15	16	90	10,28
25	1V42002500	20	16	60	12,09
32	1V42003200	25	16	40	14,33
40	1V42004000	32	16	22	18,49
50	1V42005000 ●	40	16	15	23,46
63	1V42006300 ●	50	16	8	29,24

Válvula de bola maneta azul.

H-H encolar. Junta EPDM - Asiento PE. Bidireccional.



421*

Rh	Ref.	DN	PN	U/	€ EPDM
3/8"	1V42101600	10	16	90	10,54
1/2"	1V42102000	15	16	90	11,61
3/4"	1V42102500	20	16	60	13,68
1"	1V42103200 ●	25	16	40	16,19
1 1/4"	1V42104000 ●	32	16	22	20,90
1 1/2"	1V42105000 ●	40	16	15	26,49
2"	1V42106300 ●	50	16	8	33,03

Válvula de bola maneta azul.

H-H roscar. Junta EPDM - Asiento PE. Bidireccional.



420*

d	Ref.	DN	PN	U/	€ EPDM
75	1V42007500	65	10	3	99,33
90	1V42009000 ●	80	10	3	135,16
110	1V42011000	100	10	2	241,61

Válvula de bola maneta azul.

H-H encolar. Junta EPDM - Asiento PE. Bidireccional.



421*

Rh	Ref.	DN	PN	U/	€ EPDM
2 1/2"	1V42107500	65	10	3	104,36
3"	1V42109000	80	10	3	140,49
4"	1V42111000	100	10	2	236,90

Válvula de bola maneta azul.

H-H roscar. Junta EPDM - Asiento PE. Bidireccional.



Accesorios manipulados de Polietileno

INFRAESTRUCTURA





Ideales para grandes obras de polietileno en exterior

Diseño y fabricación de accesorios de polietileno a medida

Aliaxis cuenta con un taller renovado dedicado exclusivamente al diseño y fabricación de uniones a medida en polietileno, para proyectos integrales. Así como un equipo experto que ofrece la máxima versatilidad en nuestras uniones a través de soldadura a tope, para obtener cualquiera que sea la forma que el proyecto necesite.

Con este taller renovado, ampliamos nuestra capacidad para fabricar proyectos en polietileno de hasta diámetro 1.000 mm, pudiendo así atender las necesidades específicas del cliente con soluciones a medida.



Características

- Accesorios standard y a medida
- Fabricación propia bajo exigentes controles de calidad
- Reducción de presión de cada tipo de accesorio (opcional), dando la posibilidad a fabricarlos reforzados bajo demanda
- Disponibles en PE 40 y PE 100
- Tamaños desde los 63 mm hasta los 1000 mm.
- Disponible en SDR estándar 17/11/26 (otros SDR están disponibles bajo pedido)
- En cumplimiento de EN12201

Beneficios

- Resistente a la corrosión
- Baja fricción y alta tasa de flujo
- Apto para varias técnicas de instalación
- Ahorro en transporte e instalación
- Seguridad de suministro continuo
- Reducción de la huella de carbono

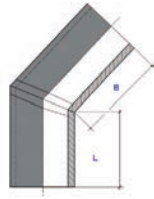
**SDR 11****CODO 30° SEGMENTADO**

Ref.	Ø	€/Ud.
089063030160	63	24,29
089075030160	75	28,04
089090030160	90	31,65
089110030160	110	36,81
089125030160	125	44,81
089140030160	140	50,18
089160030160	160	61,18
089180030160	180	69,79
089200030160	200	79,27
089225030160	225	103,84
089250030160	250	120,48
089280030160	280	153,49
089315030160	315	194,68
089355030160	355	268,66
089400030160	400	366,81
089450030160	450	475,40
089500030160	500	634,61
089560030160	560	732,04
089630030160	630	952,51

SDR 17**CODOS 30° SEGMENTADO**

Ref.	Ø	€/Ud.
089063030100	63	19,63
089075030100	75	24,35
089090030100	90	26,83
089110030100	110	30,52
089125030100	125	35,76
089140030100	140	39,63
089160030100	160	47,97
089180030100	180	53,98
089200030100	200	60,53
089225030100	225	77,34
089250030100	250	88,61
089280030100	280	111,21
089315030100	315	139,34
089355030100	355	190,92
089400030100	400	256,87
089450030100	450	340,44
089500030100	500	450,31
089560030100	560	517,73
089630030100	630	664,28
089710030100	710	937,82
089800030100	800	1.233,10
089900030100	900	1.734,57
089100030100	1000	2.255,39

**SDR 11****CODO 45° SEGMENTADO**

Ref.	∅	€/Ud.
089063045160	63	43,02
089075045160	75	50,67
089090045160	90	56,56
089110045160	110	64,71
089125045160	125	73,53
089140045160	140	84,52
089160045160	160	97,08
089180045160	180	113,51
089200045160	200	129,23
089225045160	225	154,49
089250045160	250	182,83
089280045160	280	233,19
089315045160	315	290,35
089355045160	355	388,93
089400045160	400	482,51
089450045160	450	604,87
089500045160	500	795,99
089560045160	560	920,89
089630045160	630	1.204,86

SDR 17**CODO 45° SEGMENTADO**

Ref.	∅	€/Ud.
089063045100	63	35,43
089075045100	75	43,11
089090045100	90	48,18
089110045100	110	54,00
089125045100	125	61,60
089140045100	140	67,44
089160045100	160	81,35
089180045100	180	90,25
089200045100	200	99,87
089225045100	225	123,39
089250045100	250	139,43
089280045100	280	170,85
089315045100	315	209,87
089355045100	355	284,76
089400045100	400	357,29
089450045100	450	440,69
089500045100	500	573,78
089560045100	560	661,38
089630045100	630	828,34
089710045100	710	1.157,16
089800045100	800	1.610,90
089900045100	900	2.154,42
089100045100	1000	2.944,99

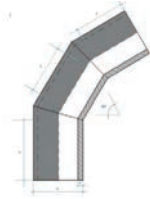

SDR 11

CODO 60° SEGMENTADO

Ref.	Ø	€/Ud.
089063060160	63	43,02
089075060160	75	50,67
089090060160	90	56,56
089110060160	110	64,71
089125060160	125	75,36
089140060160	140	84,52
089160060160	160	100,90
089180060160	180	115,28
089200060160	200	129,23
089225060160	225	163,57
089250060160	250	187,31
089280060160	280	233,19
089315060160	315	290,28
089355060160	355	397,04
089400060160	400	526,54
089450060160	450	677,40
089500060160	500	895,07
089560060160	560	1.047,00
089630060160	630	1.371,52

SDR 17

CODO 60° SEGMENTADO

Ref.	Ø	€/Ud.
089063060100	63	35,43
089075060100	75	43,24
089090060100	90	48,18
089110060100	110	54,00
089125060100	125	61,60
089140060100	140	67,44
089160060100	160	81,35
089180060100	180	90,25
089200060100	200	99,87
089225060100	225	123,39
089250060100	250	139,43
089280060100	280	170,85
089315060100	315	209,82
089355060100	355	284,76
089400060100	400	371,68
089450060100	450	489,70
089500060100	500	640,88
089560060100	560	747,38
089630060100	630	973,46
089710060100	710	1.396,40
089800060100	800	1.858,40
089900060100	900	2.642,34
089100060100	1000	3.473,45

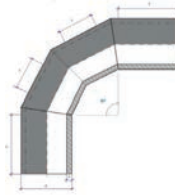
**SDR 11****CODO 90° SEGMENTADO**

Ref.	Ø	€/Ud.
089063090160	63	61,48
089075090160	75	72,19
089090090160	90	81,12
089110090160	110	92,10
089125090160	125	105,23
089140090160	140	117,75
089160090160	160	142,33
089180090160	180	158,96
089200090160	200	176,95
089225090160	225	219,76
089250090160	250	249,78
089280090160	280	306,76
089315090160	315	377,43
089355090160	355	509,90
089400090160	400	668,36
089450090160	450	879,72
089500090160	500	1.164,04
089560090160	560	1.359,22
089630090160	630	1.793,21

SDR 17**CODO 90° SEGMENTADO**

Ref.	Ø	€/Ud.
089063090100	63	51,09
089075090100	75	61,44
089090090100	90	69,29
089110090100	110	77,12
089125090100	125	86,84
089140090100	140	94,50
089160090100	160	113,76
089180090100	180	125,30
089200090100	200	137,70
089225090100	225	167,05
089250090100	250	187,30
089280090100	280	226,34
089315090100	315	274,60
089355090100	355	368,14
089400090100	400	474,39
089450090100	450	627,24
089500090100	500	811,63
089560090100	560	972,28
089630090100	630	1.275,79
089710090100	710	1.702,00
089800090100	800	2.275,86
089900090100	900	3.221,67
089100090100	1000	4.313,35

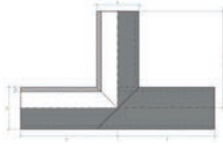

SDR 11

TE IGUAL SEGMENTADA

Ref.	Ø	€/Ud.
100063000160	63	58,39
100075000160	75	66,35
100090000160	90	75,16
100110000160	110	87,89
100125000160	125	98,50
100140000160	140	109,56
100160000160	160	132,28
100180000160	180	149,89
100200000160	200	169,17
100225000160	225	225,50
100250000160	250	260,65
100280000160	280	330,68
100315000160	315	457,72
100355000160	355	562,41
100400000160	400	751,41
100450000160	450	947,59
100500000160	500	1.262,66
100560000160	560	1.464,94
100630000160	630	1.893,89

SDR 17

TE IGUAL SEGMENTADA

Ref.	Ø	€/Ud.
100063000100	63	47,36
100075000100	75	57,96
100090000100	90	64,15
100110000100	110	73,36
100125000100	125	80,29
100140000100	140	88,39
100160000100	160	105,83
100180000100	180	118,30
100200000100	200	131,81
100225000100	225	170,52
100250000100	250	194,55
100280000100	280	242,76
100315000100	315	329,54
100355000100	355	403,92
100400000100	400	548,26
100450000100	450	681,89
100500000100	500	900,84
100560000100	560	1.043,83
100630000100	630	1.343,88
100710000100	710	1.927,15
100800000100	800	2.524,99
100900000100	900	3.353,08
100100000100	1000	4.295,37

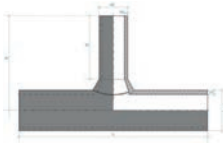

SDR 11

TE REDUCIDA

Ref.	Ø	€/Ud.
105075063160	75/63	84,07
105090063160	90/63	87,16
105090075160	90/75	93,91
105110063160	110/63	92,25
105110075160	110/75	99,00
105110090160	110/90	101,41
105125063160	125/63	97,14
105125075160	125/75	103,89
105125090160	125/90	106,30
105125090160	125/110	106,30
105140063160	140/63	102,01
105140075160	140/75	144,75

Ref.	Ø	€/Ud.
105140090160	140/90	147,17
105140110160	140/110	150,53
105140125160	140/125	198,60
105160063160	160/63	128,38
105160075160	160/75	134,33
105160090160	160/90	136,46
105160110160	160/110	139,42
105160125160	160/125	163,23
105160140160	160/140	166,08
105180063160	180/63	135,62
105180075160	180/75	141,57
105180090160	180/90	143,70

Ref.	Ø	€/Ud.
105180110160	180/110	146,67
105180125160	180/125	156,16
105180140160	180/140	174,29
105180160160	180/160	233,61
105200063160	200/63	143,84
105200075160	200/75	149,79
105200090160	200/90	151,93
105200110160	200/110	154,89
105200125160	200/125	169,38
105200140160	200/140	219,62
105200160160	200/160	262,34
105200180160	200/180	262,37
105225063160	225/63	186,98
105225075160	225/75	192,93
105225090160	225/90	195,06
105225110160	225/110	198,03
105225125160	225/125	202,63
105225140160	225/140	268,50
105225160160	225/160	275,22
105225180160	225/180	279,70
105225200160	225/200	286,96
105250063160	250/63	199,71
105250075160	250/75	205,66
105250090160	250/90	207,79
105250110160	250/110	178,13
105250125160	250/125	217,37
105250140160	250/140	288,52
105250160160	250/160	260,93
105250180160	250/180	300,73
105250200160	250/200	308,59
105250225160	250/225	381,91
105280063160	280/63	248,58
105280075160	280/75	254,53
105280090160	280/90	256,66
105280110160	280/110	260,15
105280125160	280/125	340,50
105280140160	280/140	344,91
105280160160	280/160	310,69
105280180160	280/180	321,12
105280200160	280/200	364,99
105280225160	280/225	375,54
105280250160	280/250	384,15
105315063160	315/63	271,97
105315075160	315/75	277,92
105315090160	315/90	316,04
105315110160	315/110	351,65
105315125160	315/125	405,63
105315140160	315/140	372,78
105315160160	315/160	303,51
105315180160	315/180	385,00
105315200160	315/200	536,88
105315225160	315/225	599,10
105315250160	315/250	599,10
105315280160	315/280	629,84
105355063160	355/63	346,67
105355075160	355/75	338,13

Ref.	Ø	€/Ud.
105355090160	355/90	377,37
105355110160	355/110	381,22
105355125160	355/125	403,55
105355140160	355/140	442,72
105355160160	355/160	396,99
105355180160	355/180	490,94
105355200160	355/200	501,37
105355225160	355/225	509,36
105355250160	355/250	508,14
105355280160	355/280	944,61
105355315160	355/315	662,45
105400063160	400/63	400,47
105400075160	400/75	406,42
105400090160	400/90	415,33
105400110160	400/110	450,95
105400125160	400/125	519,13
105400140160	400/140	558,30
105400160160	400/160	562,51
105400180160	400/180	642,52
105400200160	400/200	652,95
105400225160	400/225	732,95
105400250160	400/250	741,56
105400280160	400/280	810,39
105400315160	400/315	1.015,69
105400355160	400/355	1.124,62
105450063160	450/63	448,26
105450075160	450/75	454,21
105450090160	450/90	467,91
105450110160	450/110	535,30
105450125160	450/125	684,17
105450140160	450/140	723,34
105450160160	450/160	676,37
105450180160	450/180	771,56
105450200160	450/200	781,99
105450225160	450/225	789,98
105450250160	450/250	834,64
105450280160	450/280	849,66
105450315160	450/315	897,53
105450355160	450/355	1.505,76
105450400160	450/400	1.393,32
105500063160	500/63	531,17
105500075160	500/75	537,12
105500090160	500/90	585,29
105500110160	500/110	589,14
105500125160	500/125	673,18
105500140160	500/140	748,35
105500160160	500/160	666,67
105500180160	500/180	760,57
105500200160	500/200	698,99
105500225160	500/225	778,98
105500250160	500/250	832,07
105500280160	500/280	847,09
105500315160	500/315	902,61
105500355160	500/355	2.055,87
105500400160	500/400	1.906,49
105500450160	500/450	1.865,59

Ref.	Ø	€/Ud.
105560063160	560/63	611,46
105560075160	560/75	617,36
105560090160	560/90	651,43
105560110160	560/110	686,45
105560125160	560/125	783,47
105560140160	560/140	858,65
105560160160	560/160	765,81
105560180160	560/180	837,46
105560200160	560/200	828,65
105560225160	560/225	908,82
105560250160	560/250	967,37
105560280160	560/280	981,39
105560315160	560/315	1.079,08
105560355160	560/355	2.486,83
105560400160	560/400	2.734,30
105560450160	560/450	2.245,83
105560500160	560/500	2.157,38
105630063160	630/63	699,49

Ref.	Ø	€/Ud.
105630075160	630/75	716,26
105630090160	630/90	739,46
105630110160	630/110	774,48
105630125160	630/125	883,24
105630140160	630/140	958,41
105630160160	630/160	914,30
105630180160	630/180	1.039,93
105630200160	630/200	1.004,49
105630225160	630/225	1.084,66
105630250160	630/250	1.093,45
105630280160	630/280	1.169,76
105630315160	630/315	1.317,40
105630355160	630/355	3.589,15
105630400160	630/400	4.010,13
105630450160	630/450	3.575,96
105630500160	630/500	3.025,24
105630560160	630/560	2.824,24

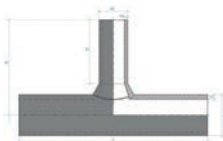

SDR 17

TE REDUCIDA

Ref.	Ø	€/Ud.
105125063100	125/63	68,25
105125110100	125/110	189,78
105160090100	160/90	88,46
105180140100	180/140	155,21
105200090100	200/90	122,30
105200110100	200/110	132,38
105250063100	250/63	175,38
105250075100	250/75	181,75
105250090100	250/90	157,48
105250110100	250/110	163,31
105250125100	250/125	201,61
105250140100	250/140	233,40
105250160100	250/160	213,64
105250180100	250/180	249,17
105250200100	250/200	271,11
105250225100	250/225	333,86
105280063100	280/63	151,81
105280075100	280/75	193,46
105280090100	280/90	193,34
105280110100	280/110	229,11
105280125100	280/125	234,34
105280140100	280/140	269,91
105280160100	280/160	243,08
105280180100	280/180	278,94
105280200100	280/200	285,08
105280225100	280/225	292,30
105280250100	280/250	298,08
105315063100	315/63	203,22
105315075100	315/75	209,59
105315090100	315/90	213,87

Ref.	Ø	€/Ud.
105315110100	315/110	216,56
105315125100	315/125	206,41
105315140100	315/140	289,11
105315160100	315/160	257,24
105315180100	315/180	370,16
105315200100	315/200	412,29
105315225100	315/225	479,57
105315250100	315/250	518,09
105315280100	315/280	561,91
105355063100	355/63	254,53
105355075100	355/75	260,91
105355090100	355/90	265,96
105355110100	355/110	245,37
105355125100	355/125	346,16
105355140100	355/140	348,43
105355160100	355/160	312,36
105355180100	355/180	357,46
105355200100	355/200	401,34
105355225100	355/225	442,83
105355250100	355/250	448,61
105355280100	355/280	755,79
105355315100	355/315	712,95
105400063100	400/63	232,05
105400075100	400/75	285,40
105400090100	400/90	292,55
105400110100	400/110	303,69
105400125100	400/125	262,92
105400140100	400/140	377,64
105400160100	400/160	369,90
105400180100	400/180	355,10

Ref.	Ø	€/Ud.
105400200100	400/200	430,55
105400225100	400/225	616,06
105400250100	400/250	620,01
105400280100	400/280	648,04
105400315100	400/315	655,45
105400355100	400/355	909,47
105450063100	450/63	311,46
105450075100	450/75	331,37
105450090100	450/90	292,10
105450110100	450/110	343,93
105450125100	450/125	385,97
105450140100	450/140	560,34
105450160100	450/160	447,44
105450180100	450/180	605,39
105450200100	450/200	541,25
105450225100	450/225	474,72
105450250100	450/250	576,86
105450280100	450/280	587,90
105450315100	450/315	620,33
105450355100	450/355	1.209,60
105450400100	450/400	1.123,94
105500063100	500/63	294,26
105500075100	500/75	387,84
105500090100	500/90	341,70
105500110100	500/110	396,15
105500125100	500/125	527,88
105500140100	500/140	566,15
105500160100	500/160	568,00
105500180100	500/180	458,35
105500200100	500/200	511,05
105500225100	500/225	588,54
105500250100	500/250	508,95
105500280100	500/280	635,46
105500315100	500/315	673,11
105500355100	500/355	1.662,81
105500400100	500/400	1.533,88
105500450100	500/450	1.473,51
105560063100	560/63	432,49
105560075100	560/75	438,94
105560090100	560/90	472,26
105560110100	560/110	442,63
105560125100	560/125	650,15
105560140100	560/140	652,41
105560160100	560/160	645,35
105560180100	560/180	530,66
105560200100	560/200	473,61
105560225100	560/225	712,36
105560250100	560/250	751,91
105560280100	560/280	762,28
105560315100	560/315	828,42
105560355100	560/355	2.008,70
105560400100	560/400	1.895,00
105560450100	560/450	1.752,20
105560500100	560/500	1.664,36
105630063100	630/63	492,37
105630075100	630/75	362,06

Ref.	Ø	€/Ud.
105630090100	630/90	401,11
105630110100	630/110	533,66
105630125100	630/125	646,00
105630140100	630/140	452,30
105630160100	630/160	650,82
105630180100	630/180	529,02
105630200100	630/200	754,10
105630225100	630/225	651,68
105630250100	630/250	607,56
105630280100	630/280	890,12
105630315100	630/315	990,07
105630355100	630/355	2.972,08
105630400100	630/400	2.429,96
105630450100	630/450	2.245,90
105630500100	630/500	2.136,14
105630560100	630/560	1.966,30
105710063100	710/63	603,82
105710075100	710/75	610,27
105710090100	710/90	643,59
105710110100	710/110	590,79
105710125100	710/125	772,32
105710140100	710/140	774,58
105710160100	710/160	721,38
105710180100	710/180	821,38
105710200100	710/200	850,73
105710225100	710/225	892,33
105710250100	710/250	987,70
105710280100	710/280	1.034,07
105710315100	710/315	1.129,94
105710355100	710/355	4.432,41
105710400100	710/400	4.175,58
105710450100	710/450	4.003,49
105710500100	710/500	3.006,81
105710560100	710/560	2.804,08
105710630100	710/630	2.632,85
105800063100	800/63	721,22
105800075100	800/75	727,67
105800090100	800/90	760,98
105800110100	800/110	763,27
105800125100	800/125	887,36
105800140100	800/140	907,63
105800160100	800/160	888,72
105800180100	800/180	1.029,04
105800200100	800/200	1.103,41
105800225100	800/225	1.127,01
105800250100	800/250	1.168,92
105800280100	800/280	1.247,11
105800315100	800/315	1.434,44
105800355100	800/355	5.462,18
105800400100	800/400	5.345,98
105800450100	800/450	5.173,89
105800500100	800/500	5.084,59
105800560100	800/560	3.823,04
105800630100	800/630	3.587,46
105800710100	800/710	3.414,13



SDR 11
REDUCCIÓN

Ref.	Ø	€/Ud.
110200160160	200/160	193,45
110225110160	225/110	264,28
110225160160	225/160	165,24
110225180160	225/180	173,74
110225200160	225/200	178,86
110250160160	250/160	199,46
110250180160	250/180	327,56
110280180160	280/180	319,07
110280200160	280/200	346,13
110280225160	280/225	217,81
110280250160	280/250	225,17
110315200160	315/200	332,06
110315225160	315/225	230,36
110315250160	315/250	237,73
110315280160	315/280	247,43
110355250160	355/250	649,79
110355280160	355/280	654,57
110355315160	355/315	510,28
110400280160	400/280	689,40
110400315160	400/315	534,51
110400355160	400/355	571,06
110450315160	450/315	581,00
110450355160	450/355	611,59
110450400160	450/400	638,43
110500355160	500/355	1.232,14
110500400160	500/400	1.459,74
110500450160	500/450	906,29
110560400160	560/400	1.331,91
110560450160	560/450	973,98
110560500160	560/500	1.331,57
110630450160	630/450	1.067,96
110630500160	630/500	1.104,51
110630560160	630/560	1.172,19

SDR 17
REDUCCIÓN

Ref.	Ø	€/Ud.
110225160100	225/160	142,65
110225180100	225/180	147,19
110225200100	225/200	150,69
110250160100	250/160	171,63
110250180100	250/180	282,74
110250225100	250/225	174,62
110280200100	280/200	295,37
110280225100	280/225	181,28
110280250100	280/250	186,22
110315160100	315/160	288,76
110315225100	315/225	189,85
110315250100	315/250	194,79
110315280100	315/280	201,45
110355250100	355/250	565,06
110355280100	355/280	573,22
110355315100	355/315	438,81
110400280100	400/280	583,22
110400315100	400/315	455,00
110400355100	400/355	592,18
110450315100	450/315	486,47
110450355100	450/355	512,11
110450400100	450/400	528,30
110500355100	500/355	1.062,35
110500400100	500/400	1.255,31
110500450100	500/450	757,25
110560250100	560/250	1.157,81
110560400100	560/400	1.454,63
110560450100	560/450	803,04
110560500100	560/500	828,06
110630450100	630/450	866,77
110630500100	630/500	891,79
110630560100	630/560	937,59
110710500100	710/500	2.004,61
110710560100	710/560	1.789,21
110710630100	710/630	1.630,48
110800560100	800/560	2.506,66
110800630100	800/630	2.289,47
110800710100	800/710	2.139,66
110900630100	900/630	3.456,89
110900710100	900/710	3.192,56
110900800100	900/800	2.571,11
110100710100	1000/710	5.301,86
110100800100	1000/800	4.127,70
110100900100	1000/900	5.024,41

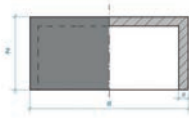

SDR 11
TAPÓN

Ref.	Ø	€/Ud.
138063000160	63	37,04
138075000160	75	42,95
138090000160	90	48,67
138110000160	110	60,44
138125000160	125	67,73
138140000160	140	75,51
138160000160	160	90,55
138180000160	180	106,86
138200000160	200	125,02
138225000160	225	145,40
138250000160	250	167,73
138280000160	280	197,40
138315000160	315	236,05
138355000160	355	315,37
138400000160	400	387,22
138450000160	450	496,36
138500000160	500	596,03
138560000160	560	760,01
138630000160	630	935,78

SDR 17
TAPÓN

Ref.	Ø	€/Ud.
138063000100	63	32,64
138075000100	75	39,19
138090000100	90	43,83
138110000100	110	54,24
138125000100	125	60,08
138140000100	140	66,77
138160000100	160	79,81
138180000100	180	93,08
138200000100	200	108,88
138225000100	225	126,14
138250000100	250	144,96
138280000100	280	170,21
138315000100	315	203,06
138355000100	355	266,59
138400000100	400	326,67
138450000100	450	414,05
138500000100	500	496,94
138560000100	560	629,09
138630000100	630	774,60
138710000100	710	1.000,03
138800000100	800	1.255,00
138900000100	900	1.503,07
105180140100	1000	155,21



Pasamuros y juntas

INFRAESTRUCTURA





PASAMUROS DE PE

Con extremo liso & brida según EN1092 PN10

Ref.	DN	Ø	L	€/Ud
750310106	25	32	250	192,16
750410106	32	40	250	222,22
750510106	40	50	250	235,32
750610106	50	63	250	251,09
750710106	65	75	250	281,42
750910106	80	90	250	347,88
751110106	100	110	250	367,09
751210106	100	125	250	377,40
751310106	125	125	250	391,28
751410106	125	140	250	429,47
751610106	150	160	250	494,51
751810106	150	180	250	538,57
752010106	200	200	250	584,15
752210106	200	225	250	630,93
752510106	250	250	250	767,50
752810106	250	280	250	837,07
753110106	300	315	250	878,41
753410106	300	355	250	1.044,01
753510106	350	355	250	1.130,79
753910106	350	400	250	1.372,60
754010106	400	400	250	1.369,66
754410106	400	450	250	1.618,86
754510106	500	450	250	1.643,16
755010106	500	500	250	2.091,26
755410106	500	560	250	2.263,84
755610106	600	560	300	2.050,93
756310106	600	630	300	3.075,81
757110106	700	710	350	CONSULTAR
758010106	800	800	350	CONSULTAR
759010106	900	900	400	CONSULTAR
759110106	1000	1000	400	CONSULTAR

Junta central en EPDM, anclajes en acero cincado.

Extremo liso SDR 17 según 12201.

Para paredes con espesor = L.

Consultar alternativa en PN16.

Consultar longitudes extra.



PASAMUROS DE PE

Embridado según EN1092 PN10

Ref.	DN	Ø	L	€/Ud
750320106	25	32	250	262,73
750420106	32	40	250	354,67
750520106	40	50	250	511,92
750620106	50	63	250	412,92
750720106	65	75	250	482,28
750920106	80	90	250	548,30
751120106	100	110	250	604,21
751220106	100	125	250	621,02
751320106	125	125	250	635,94
751420106	125	140	250	705,84
751620106	150	160	250	825,17
751820106	150	180	250	871,95
752020106	200	200	250	947,28
752220106	200	225	250	1.018,94
752520106	250	250	250	1.274,01
752820106	250	280	250	1.357,33
753120106	300	315	250	1.461,79
753420106	300	355	250	1.706,48
753520106	350	355	250	1.833,16
753920106	350	400	250	2.253,67
754020106	400	400	250	2.320,35
754420106	400	450	250	2.564,98
754520106	500	450	250	3.190,34
755020106	500	500	250	3.470,97
755420106	500	560	250	3.853,30
755620106	600	560	300	3.615,83
756320106	600	630	300	5.112,74
757120106	700	710	350	CONSULTAR
758020106	800	800	350	CONSULTAR
759020106	900	900	400	CONSULTAR
759120106	1000	1000	400	CONSULTAR

Junta central en EPDM, anclajes en acero cincado

Extremo liso SDR 17 según 12201

Para paredes con espesor = L.

Consultar alternativa en PN16.

Otras configuraciones: pasamuros en ángulo disponibles
 previa consulta.



JUNTAS YUNTALEX

Ref.	Ø Tubo	DN Brida	Uds./caja	€/Ud
315020045535	20	15	50	1,78
315025055535	25	20	50	1,80
315030065535	32	25	50	1,90
315045085535	50	40	50	1,98
315055100535	63	50	50	2,12
315070120535	75	65	50	2,24
315085135535	90	80	50	2,58
315105155535	110	100	50	2,60
315135185535	125	125	50	2,87
315160210535	160	150	50	3,52
315210265535	200	200	50	4,72
315260320535	250	250	25	4,96
315310375535	315	300	15	7,80
315360435535	355	350	15	12,00
315410485535	400	400	15	12,47
315510610535	500	500	15	22,34
315610725535	630	600	15	29,77

Junta de plástico flexible, totalmente terminada que no requiere otra manipulación que la de su inmediata colocación entre bridas de unión de dos tubos durante su atornillado. Anticorrosivas, impermeables, imputrescibles e inalterables a la acción de la mayoría de los ácidos, aceites e hidrocarburos. Resistencia a la temperatura de hasta 60°C y presiones hasta 30 atmósferas. Sin desperdicios por recortes ni costes de mano de obra por manipulación. Se mantienen fijas con tan solo dos dedos durante el atornillado de las bridas entre sí. Duración ilimitada.



QPV-J

Ref.	Ø	€/FKM
QH VX020F	20	5,94
QH VX025F	25	5,94
QH VX032F	32	6,33
QH VX040F	40	8,84
QH VX050F	50	8,77
QH VX063F	63	14,77
QH VX075F	75	19,70
QH VX090F	90	21,85
QH VX110F	110	39,24
QH VX125F	125	54,14
QH VX140F	140	62,56
QH VX160F	160	91,68

Junta plana para portabridas.
Junta en FKM (vitón).

Ver descuentos aplicables según "Familia PVC".



QPV-J

Ref.	Ø	€/EPDM
QH VX020E	20	0,70
QH VX025E	25	0,77
QH VX032E	32	1,17
QH VX040E	40	1,34
QH VX050E	50	1,61
QH VX063E	63	2,12
QH VX075E	75	3,27
QH VX090E	90	4,72
QH VX110E	110	5,99
QH VX125E	125	6,71
QH VX140E	140	2,99
QH VX160E	160	8,38
QH VX200E	200	9,82
QH VX225E	225	12,20
QH VX250E	250	34,24

Junta plana para portabridas.
Junta en EPDM.

Ver descuentos aplicables según "Familia PVC".

Accesorios electrosoldables PE

Tomas simples

Tomas en carga

Válvulas PE para agua y gas



Accesorios electrosoldables

Frialen

INFRAESTRUCTURA





Más información



Aplicación



Aplicación

**MB - MANGUITOS CON TOPE, SDR 11**

Máxima presión de trabajo permitida 16 bar
(agua) / 10 bar (gas)

Ref.	Ø	Ud./Caja	€/Ud.
612680	20	110	2,75
612681	25	90	2,82
616517	32	60	2,87
612683	40	40	3,22
612684	50	25	5,01
612685	63	15	5,11
612686	75	50	9,54
612687	90	30	8,84

Los manguitos MB SDR11 pueden ser soldados en tuberías SDR11 a SDR17,6

Espesor mínimo de tubo a soldar: 3.0 mm



Aplicación

**UB SDR9 - MANGUITOS SIN TOPE, SDR 9**

Máxima presión de trabajo permitida 20 bar
(agua)

Ref.	Ø	Ud./Caja	€/Ud.
616441	400	1	726,76
616447	450	1	890,87
616445	500	1	1.257,26
616446	560	1	2.981,96
616439	630	1	4.133,66

Los manguitos UB SDR9 pueden ser soldados en tuberías SDR9 y SDR11

UB - MANGUITOS SIN TOPE, SDR 11

Máxima presión de trabajo permitida 16 bar
(agua) / 10 bar (gas)

Ref.	Ø	Ud./Caja	€/Ud.
612668	110	24	10,32
612669	125	16	14,18
615001	140	12	19,03
612671	160	8	19,18
612672	180	6	33,11
612673	200	1	37,00
612674	225	1	46,89
617278	250	1	90,73
615073	280	1	122,25
612670	315	1	147,91
615074	355	1	200,20
615075	400*	1	293,61
615076	450*	1	523,32
615124	500*	1	605,83
616312	560*	1	2.270,69
616269	630*	1	2.571,73
616313	710*	1	2.898,95
616314	800*	1	7.382,31

* zonas de soldadura separada

Los manguitos UB SDR11 pueden ser soldados en tuberías SDR11 a SDR17,6

Espesor mínimo de tubo a soldar: 3.0 mm



Aplicación



UB - MANGUITOS SIN TOPE, SDR 17

Máxima presión de trabajo permitida 10 bar (agua) / 5 bar (gas)

Ref.	Ø	Ud./Caja	€/Ud.
616529	315	1	119,78
616530	355	1	199,76
616531	400*	1	220,56
616532	450*	1	312,70
616533	500*	1	424,55
615706	560*	1	643,11
615726	630*	1	830,64
615994	710*	1	1.142,99
616290	800*	1	1.500,45
616345	900*	1	2.020,54
616403	1000**	1	9.307,51
616416	1200**	1	16.565,08

* zonas de soldadura separada

** Para soldar se necesita una FRIAMAT XL

Los manguitos UB SDR17 pueden ser soldados en tuberías SDR17 y SDR26



Aplicación



UB PN25 - MANGUITOS SIN TOPE, SDR 7,4

Máxima presión de trabajo permitida 25 bar (agua)

Ref.	Ø	Ud./Caja	€/Ud.
616270	90	30	10,99
616271	110	24	21,38
616272	125	16	24,25
616273	140	12	105,01
616274	160	8	129,74
616282	180	6	130,27
616283	200	2	140,39
616284	225	1	156,18
616285	250	1	210,32
616287	315*	1	460,11
616288	355*	1	501,20

* zonas de soldadura separada

Los manguitos UB SDR7,4 pueden ser soldados en tuberías SDR7,4 a SDR11



Aplicación



Para aguas residuales

AM - MANGUITOS SIN TOPE, SDR 17

Máxima presión de trabajo permitida 10 bar (agua)

Ref.	Ø	Ud./Caja	€/Ud.
680001	110	24	11,66
680013	125	22	16,58
680002	160	12	15,35
680003	180	8	26,83
680004	200	1	26,93
680005	225	4	45,77
680006	250	1	108,70
680007	280	1	117,17

* zonas de soldadura separada

Los manguitos AM SDR17 pueden ser soldados en tuberías SDR17 a SDR33



Aplicación



REM - MANGUITOS DE TRANSICIÓN RELINING

PE 100 SDR17 Presión de servicio máxima admisible 10 bar (agua)/5 bar (gas)

Ref.	Ø	Ud./Caja	€/Ud.
615569	110/100	24	138,27
615571	160/150	12	250,50
615576	315/300	1	989,51

Con código de barras de precalentamiento

Los manguitos REM pueden ser soldados en tuberías SDR17 a SDR17,6



Aplicación



MV - MANGUITOS DE CIERRE - TAPONES

PE 100 SDR11 - Máxima presión de trabajo permitida 16 bar (agua) / 10 bar (gas)

Ref.	Ø	Ud./Caja	€/Ud.
612025	20	40	5,51
612026	25	40	5,60
612027	32*	40	5,90
612028	40*	25	7,23
612029	50	20	10,24
612030	63	15	10,50
612031	75	20	20,69
612032	90	16	23,74
612033	110	12	29,09
612034	125	16	42,94
612035	160	10	56,73
616183	180	6	135,30
616184	200	4	174,08
616185	225	4	251,88

* También recomendado para sellar los extremos de accionamiento de las cuchillas de corte de las tomas en carga FRIALEN DAA/DAP ≤ d63.

Los tapones MV pueden ser soldados en tuberías SDR11 a SDR17,6

Espesor mínimo de tubo a soldar: 3.0 mm



Aplicación



MR - MANGUITOS DE REDUCCIÓN

Máxima presión de trabajo permitida 16 bar (agua) / 10 bar (gas)

Ref.	Ø	Ud./Caja	€/Ud.
616824	20-16	70	5,83
616452	32-16	70	6,78
615386	32-20	80	7,42
615502	32-25	70	6,95
615387	40-20	60	8,91
616751	40-25	120	7,07
615388	40-32	50	13,06
616752	50-25	130	8,76
612070	50-32	32	9,32
612071	50-40	25	7,86
615389	63-32	18	9,58
615390	63-40	16	9,58
612072	63-50	16	9,58
616583	75-63	15	19,02
615391	90-50	15	21,78
615392	90-63	15	19,80
616582	90-75	15	22,93
615393	110-63	10	23,00
615693	110-90	8	23,28
615694	125-90	8	28,70
616510	125-110	16	53,33
615695	160-110	8	45,19
616511	180-125	1	80,21
616356	225-160	1	133,80

Las reducciones MR pueden ser soldadas en tuberías SDR11 a SDR17,6

Espesor mínimo de tubo a soldar: 3.0 mm



Aplicación



WS11° - CODOS 11° M/H

PE 100 SDR11 Presión de servicio máxima admisible 16 bar (agua)/10 bar (gas)

Ref.	Ø	Ud./Caja	€/Ud.
616139	110	8	34,16
616140	125	5	46,60
616141	160	8	89,32
616142	180	4	115,70
616143	225	1	199,57

Los codos WS 11 ° pueden ser soldados en tuberías SDR11 a SDR17,6

Espesor mínimo de tubo a soldar: 3.0 mm



Aplicación



W30° - CODOS 30°

PE 100 SDR11 Presión de servicio máxima admisible 16 bar (agua)/10 bar (gas)

Ref.	Ø	Ud./Caja	€/Ud.
615272	90	8	28,24
615273	110	6	40,36
615274	125	4	54,69
615340	160	5	105,65
616261	180	3	133,93
616262	200	1	184,22
616263	225	1	226,04

Los codos W 30° pueden ser soldados en tuberías SDR11 a SDR17,6



Aplicación



W45° - CODOS 45°

PE 100 SDR11 Presión de servicio máxima admisible 16 bar (agua)/10 bar (gas)

Ref.	Ø	Ud./Caja	€/Ud.
616687	25	150	7,83
612092	32	45	7,70
612094	40	25	9,62
612096	50	20	10,92
612098	63	10	11,08
612100	75	14	20,36
612102	90	8	23,68
612104	110	10	33,70
612106	125	10	54,08
615275	160	4	83,77
615687	180	3	89,71
616264	200	1	207,35
615688	225	1	161,66

Los codos W 45 ° pueden ser soldados en tuberías SDR11 a SDR17,6



Aplicación



W45° XL - CODOS 45° XL

PE 100 SDR11 Presión de servicio máxima admisible 16 bar (agua)/10 bar (gas)

Ref.	Ø	Ud./Caja	€/Ud.
616404	250	1	813,99
616405	280	1	985,90
616406	315	1	1.303,19

Los codos W 45 ° XL pueden ser soldados en tuberías SDR11 a SDR17,6



Aplicación



W90° XL - CODO 90° XL

PE 100 SDR11 Presión de servicio máxima admisible 16 bar (agua)/10 bar (gas)

Ref.	Ø	Ud./Caja	€/Ud.
616408	250	1	818,84
616409	280	1	985,90
616410	315	1	1.303,19

Los codos W 90 ° XL pueden ser soldados en tuberías SDR11 a SDR17,6



Aplicación



W90° - CODOS 90°

PE 100 SDR11 Presión de servicio máxima admisible 16 bar (agua)/10 bar (gas)

Ref.	Ø	Ud./Caja	€/Ud.
616686	20	200	7,35
612091	25	60	7,39
612093	32	45	7,41
612095	40	25	7,85
612097	50	20	11,79
612099	63	8	11,06
612101	75	12	19,37
612103	90	6	21,56
612105	110	10	31,19
612107	125	8	50,27
615276	160	3	83,67
615689	180	3	95,79
616265	200	2	195,67
615690	225	1	234,82

Los codos W 90 ° pueden ser soldados en tuberías SDR11 a SDR17,6



Aplicación



TA RED - TÉS REDUCIDAS

PE 100 SDR11 Presión de servicio máxima admisible 16 bar (agua)/10 bar (gas)

Ref.	Ø	Ud./Caja	€/Ud.
616417	32- 20	30	9,23
616418	40- 32	20	12,78
616419	50- 32	10	16,30
616420	50- 40	10	15,73
616421	63- 32	10	17,64
616422	63- 40	10	18,52
616423	63- 50	10	18,69

Las tés TA red pueden ser soldadas en tuberías SDR11 a SDR17,6



Aplicación



TA - TÉS CON DERIVACIÓN EXTRA LARGA

PE 100 SDR11 Presión de servicio máxima admisible 16 bar (agua)/10 bar (gas)

Ref.	Ø	Ud./Caja	€/Ud.
616685	20	200	8,39
616338	25	40	8,49
615719	32	30	8,59
615720	40	20	12,08
615721	50	10	13,61
615722	63	10	14,27

Las tés TA red pueden ser soldadas en tuberías SDR11 a SDR17,6
Espesor mínimo de tubo a soldar: 3.0 mm



Aplicación



T - TÉS DE TRES BOCAS Y DOS SOLDADURAS

PE 100 SDR11 Presión de servicio máxima admisible 16 bar (agua)/10 bar (gas)

Ref.	Ø	Ud./Caja	€/Ud.
612165	75	8	27,84
612166	90	10	46,91
612167	110	6	46,55
612168	125	5	65,82
615277	160	3	110,34
615691	180	2	165,71
616266	200	1	215,81
615692	225	1	235,45

Las tés T pueden ser soldadas en tuberías SDR11 a SDR17,6



Aplicación



T XL - TÉS XL

PE 100 SDR11 Presión de servicio máxima admisible 16 bar (agua)/10 bar (gas)

Ref.	Ø	Ud./Caja	€/Ud.
616412	250*	1	1.157,78
616413	280*	1	1.443,36
616414	315*	1	1.920,63

*Pieza conformada por cuerpo inyectado y dos manguitos bifilares soldados en uno de sus extremos. Para alternativa de inyectado + 3 manguitos utilizar precios de Ref.s TEPE11000250, TEPE11000280 Y TEPE11000315 dela familia de Inyectados y las 617278,615073 y 612670 de Electrosoldables.

Las tés T XL pueden ser soldadas en tuberías SDR11 a SDR17,6



Aplicación



TE RED - XL - TÉS REDUCIDA XL

PE 100 SDR11 Presión de servicio máxima admisible 16 bar (agua)/10 bar (gas)

Ref.	Ø	Ud./Caja	€/Ud.
616426	250/110	1	1.120,84
616427	250/225	1	1.224,17
616428	280/110	1	1.375,25
616429	280/225	1	1.482,28
616430	315/110	1	1.720,85
616431	315/225	1	1.768,53

*Pieza conformada por cuerpo inyectado y dos manguitos bifilares soldados en uno de sus extremos.

Para alternativa de manipulados + 2 manguitos utilizar precios de Ref.s de tés reducidas en capítulo Manipulados y para los manguitos las Ref.s en capítulo Electrosoldables.

Las tés T red XL pueden ser soldadas en tuberías SDR11 a SDR17,6



Aplicación



Y - PIEZAS EN Y DE PE 100 SDR11

PE 100 SDR11 Presión de servicio máxima admisible 16 bar (agua)/10 bar (gas)

Ref.	Ø	Ud./Caja	€/Ud.
640034	32-32-40	28	37,95
640036	40-40-50	18	41,23



Aplicación



YS - PIEZAS EN YS CON ESPIRALES CALEFACTORAS Y EXTREMO PE 100 SDR11

PE 100 SDR11 Presión de servicio máxima admisible 16 bar (agua)/10 bar (gas)

Ref.	Ø	Ud./Caja	€/Ud.
640035	32-32-40	28	31,77
640037	40-40-50	18	36,00

Las Y y las YS pueden ser soldadas en tuberías SDR11 a SDR17,6



USTR - TRANSICIONES PE-AD/ACERO

PE 100 SDR11 Presión de servicio máxima admisible 10 bar (gas)

Ref.	Ø	Ud./Caja	€/Ud.
612780	32/25	15	44,08
612781	40/32	10	49,38
612782	50/40	8	61,17
612783	63/50	6	75,56
612789	75/65	4	172,39
612784	90/80	1	244,37
612785	110/100	1	249,42
612786	125/100	1	298,10
612787	160/150	1	443,97
615030	180/150	1	598,92
612795	200/200	1	677,95
612370	225/200	1	787,63

Otras dimensiones de rosca, o modelos, bajo consulta.
Las USTR pueden ser soldadas en tuberías SDR11 a SDR17,6



USTRS - TRANSICIONES PE-AD/ACERO (PARA SOLDAR CON MANGUITOS)

PE 100 SDR11 Presión de servicio máxima admisible 10 bar (gas)

Ref.	Ø	Ud./Caja	€/Ud.
616632	20/15	21	27,80
616633	25/20	21	30,89
616634	32/25	18	34,13
616635	40/32	12	39,02
616636	50/40	8	44,35
616637	63/50	6	58,56
616638	75/65	2	106,22
616639	90/80	2	108,31
616640	110/100	2	159,63
616641	125/100	2	166,93
616642	140/125	1	232,94
616643	160/150	1	383,62
616644	180/150	1	387,25
616645	200/200	1	564,16
616646	225/200	1	572,45
616647	250/250	1	1.117,37
616648	280/250	1	1.187,95
616649	315/300	1	1.748,74
616650	355/300	1	1.905,27
616651	400/400	1	3.934,36
616652	500/500	1	8.072,25
616653	630/600	1	13.639,31

Otras dimensiones de rosca, o modelos, bajo consulta.
Las USTRS pueden ser soldadas en tuberías SDR11 a SDR17,6



UFLG - TRANSICIONES PARA GAS LICUADO EN PE-AD/COBRE

PE 100 SDR11 Presión de servicio máxima admisible 5 bar (gas)

Ref.	Ø	Ud./Caja	€/Ud.
615733	32-20	25	84,25

Las UFLG pueden ser soldadas en tuberías SDR11 a SDR17,6



USTN - MANGUITOS DE TRANSICIÓN PE-AD/ACERO (ROSCA MACHO)

PE 100 SDR11 Presión de servicio máxima admisible 5 bar (gas)

Ref.	Ø	Ud./Caja	€/Ud.
612580	32-1"	20	30,51
612582	40-1 ¼"	20	39,87
612584	50-1 ½"	15	50,28
612586	63-2"	10	65,64

Otras dimensiones de rosca,, bajo consulta.
Las transiciones USTN pueden ser soldadas en tuberías SDR11 a SDR17,6
Espesor mínimo de tubo a soldar: 3.0 mm



USTM - MANGUITOS DE TRANSICIÓN PE-AD/ACERO (ROSCA HEMBRA)

PE 100 SDR11 Presión de servicio máxima admisible 5 bar (gas)

Ref.	Ø	Ud./Caja	€/Ud.
612570	32-1"	20	32,23
612572	40-1 ¼"	20	43,18
612574	50-1 ½"	15	52,74
612576	63-2"	10	71,22

Otras dimensiones de rosca,, bajo consulta.
Las transiciones USTM pueden ser soldadas en tuberías SDR11 a SDR17,6
Espesor mínimo de tubo a soldar: 3.0 mm



Aplicación



WUSTN 90° - CODOS DE TRANSICIÓN 90° UNIÓN PE-AD/ACERO (ROSCA MACHO)

PE 100 SDR11 Presión de servicio máxima admisible 5 bar (gas)

Ref.	Ø	Ud./Caja	€/Ud.
612602	40-1 ¼"	15	77,29
612604	50-1 ½"	10	61,54
612606	63-2"	10	80,40

Otras dimensiones de rosca, bajo consulta.

Las transiciones WUSTN pueden ser soldadas en tuberías SDR11 a SDR17,6

Espesor mínimo de tubo a soldar: 3.0 mm



Aplicación



WUSTM 90° - CODOS DE TRANSICIÓN 90° UNIÓN PE-AD/ACERO (ROSCA HEMBRA)

PE 100 SDR11 Presión de servicio máxima admisible 5 bar (gas)

Ref.	Ø	Ud./Caja	€/Ud.
612610	32-1"	20	33,49
612611	40-1"	15	62,67
612612	40-1 ¼"	15	75,40
612614	50-1 ½"	10	56,36
612616	63-2"	10	78,20

Otras dimensiones de rosca, o modelos, bajo consulta.

Las transiciones WUSTM pueden ser soldadas en tuberías SDR11 a SDR17,6

Espesor mínimo de tubo a soldar: 3.0 mm



Aplicación



MUN - MANGUITOS DE TRANSICIÓN UNIÓN PE-AD/LATÓN (ROSCA MACHO HEXAGONAL)

PE 100 SDR11 Presión de servicio máxima admisible 16 bar (agua)

Ref.	Ø	Ud./Caja	€/Ud.
612712	32-1"	20	25,39
612709	32-1 ¼"	20	37,61
612698	32-1 ½"	15	39,67
612721	40-1"	20	37,59
612713	40-1 ¼"	20	32,11
612718	40-1 ½"	20	43,22
612725	40-2"	20	74,45
612719	50-1"	15	50,43
612716	50-1 ¼"	15	49,06
612714	50-1 ½"	15	40,59
612706	50-2"	15	56,40
612722	63-1 ¼"	10	81,58
612717	63-1 ½"	10	71,97
612715	63-2"	10	60,21
612694	75-2"	10	140,96
612695	75-2 ½"	10	140,59

Estándar: latón. Otros materiales bajo consulta.

Otras dimensiones de rosca, bajo consulta.

Las transiciones MUN pueden ser soldadas en tuberías SDR11 a SDR17,6

Espesor mínimo de tubo a soldar: 3.0 mm



Aplicación



MUM - MANGUITOS DE TRANSICIÓN UNIÓN PE-AD/FUNDICIÓN (ROSCA HEMBRA HEXAGONAL)

PE 100 SDR11 Presión de servicio máxima admisible 16 bar (agua)

Ref.	Ø	Ud./Caja	€/Ud.
612595	32-1"	20	37,61
612596	40-1 ¼"	20	52,43
612692	50-1 ½"	15	63,45
612708	63-1 ½"	10	149,50
612693	63-2"	10	96,88

Estándar: latón. Otros materiales bajo consulta.

Otras dimensiones de rosca, bajo consulta.

Las transiciones MUM pueden ser soldadas en tuberías SDR11 a SDR17,6

Espesor mínimo de tubo a soldar: 3.0 mm



Aplicación



UAM ET - MANGUITOS DE TRANSICIÓN PE-AD / LATÓN CON TUERCA MÓVIL Y ROSCA HEMBRA

PE 100 SDR11 Presión de servicio máxima admisible 16 bar (agua)

Ref.	Ø	Ud./Caja	€/Ud.
616654	25-3/4"	100	46,00
616655	32-1"	60	54,13
616626	40-1 1/4"	35	68,67
616627	50-1 1/2"	30	77,90
616628	63-2"	20	107,63
616629	63-1 1/2"	20	96,98

Otras dimensiones de rosca, bajo solicitud.

Estándar: latón, acero bajo consulta

La junta de sellado no está incluida



Aplicación



WUN 90° - CODOS DE TRANSICIÓN PE-AD/ LATÓN (ROSCA MACHO HEXAGONAL)

PE 100 SDR11 Presión de servicio máxima admisible 16 bar (agua)

Ref.	Ø	Ud./Caja	€/Ud.
612120	32-1"	20	28,91
612140	32-1 1/2"	20	41,80
612127	40-1"	15	39,16
612122	40-1 1/4"	15	43,78
612121	40-1 1/2"	15	44,88
612119	50-1"	10	51,40
612123	50-1 1/4"	10	50,60
612124	50-1 1/2"	10	42,02
612125	63-1 1/2"	10	75,40
612126	63-2"	10	71,23

Estándar: latón. Otros materiales bajo consulta.

Otras dimensiones de rosca, bajo consulta.



Aplicación



UAN - TRANSICIONES ADAPTADOR MACHO PE-AD/LATÓN

PE 100 SDR11 Presión de servicio máxima admisible 16 bar (agua)/5 bar (gas)

Ref.	Ø	Ud./Caja	€/Ud.
616604	20-1/2"	100	13,03
616605	25-3/4"	100	16,56
616152	32-1"	60	24,80
616153	40 - 1 1/4"	35	34,03
616154	50-1 1/2"	30	34,88
616610	63-1 1/2"	20	49,10
616155	63-2"	20	44,71
616612	75-2 1/2"	14	85,57
616613	90-3"	6	106,66
616614	110-4"	4	180,36
616664	125-4"	4	199,86

Otras dimensiones de rosca,, bajo consulta.



Aplicación



UAM - TRANSICIONES ADAPTADOR HEMBRA PE-AD/LATÓN

PE 100 SDR11 Presión de servicio máxima admisible 16 bar (agua)/5 bar (gas)

Ref.	Ø	Ud./Caja	€/Ud.
616615	20-1/2"	150	10,14
616616	25-3/2"	100	16,53
616156	32-1"	60	19,33
616157	40-1 1/4"	50	28,43
616158	50-1 1/2"	35	32,49
616621	63-1 1/2"	20	41,29
616159	63 - 2"	20	41,13
616665	75-2 1/2"	14	77,11
616623	90-3"	10	86,30
616624	110-4"	6	160,09
616666	125-4"	6	165,46

Otras dimensiones de rosca,, bajo consulta.



Aplicación



EFL - PORTABRIDAS EMBRIDADAS
 PE 100 SDR11 Presión de servicio máxima
 admisible 16 bar (agua)/5 bar (gas)

Ref.	Ø	Ud./Caja	€/Ud.
615417	63/50	5	86,40
615418	90/80	5	94,84
615419	110/100	3	105,29
615605	125/100	2	120,44
615421	160/150	2	182,63
615927	180/150	2	213,66
615607	225/200*	1	261,89

* Agujeros de brida para PN 10



Aplicación



RS -XL - ABRAZADERAS DE REPARACIÓN
 PE 100 SDR11 Presión de servicio máxima
 admisible 16 bar (agua)/10 bar (gas)

Ref.	Ø	Ud./Caja	€/Ud.
616366	500	1	4.927,22
616367	560	1	5.214,70
616368	630	1	5.387,96
616369	710	1	5.586,27
616370	800	1	5.947,43
616371	900	1	6.278,31
616372	1000	1	6.460,96
616379	1200	1	6.772,00



Aplicación



SA - TOMAS SIMPLES

PE 100 SDR11 Presión de servicio máxima admisible 16 bar (agua)/10 bar (gas)

Ref.	Ø	Ud./Caja	€/Ud.
612757	63-32*	20	37,02
612759	63-50*	20	32,94
615020	75-50	15	39,31
615285	90-32	20	44,10
612819	90-63	20	39,52
615334	110-32	12	48,09
615031	110-50	12	45,28
612760	110-63	12	43,92
615411	110-90	12	68,82
615087	125-32	12	54,07
612761	125-63	12	50,51
615412	125-90	12	52,25
615584	125-110	10	62,11
612886	160-32	8	115,20

Ref.	Ø	Ud./Caja	€/Ud.
612762	160-63	6	96,90
615413	160-90	2	93,28
615739	160-110	2	105,16
615585	160-125	2	98,16
612763	180-63	6	59,67
615414	180-90	2	104,15
615948	180-110	2	106,21
615740	180-125	2	103,39
612764	200-63	5	56,17
612765	225-63	5	57,74
615415	225-90	5	101,55
616044	225-110	5	112,14
616045	225-125	4	124,05
616046	225-160	4	112,85

Las tomas simples SA pueden ser soldadas en tuberías SDR11 a SDR17,6

*Excepto las Ø 63 que solo pueden serlo con SDR11



Aplicación



SA-TL - TOMA SIMPLE SA-TL

PE 100 SDR11 Presión de servicio máxima admisible 16 bar (agua)/10 bar (gas)

Ref.	Ø1	Ø2	Ø3	Ud./Caja	€/Ud.
615465	250/560	32	21	5	90,86
615466	250/560	63	47	5	100,16

Las tomas simples SA-TL pueden ser soldadas en tuberías SDR11 a SDR17,6



Aplicación



SA-XL - TOMA SIMPLE SA-XL

PE 100 SDR11 Presión de servicio máxima admisible 16 bar (agua)/10 bar (gas)

Ref.	Ø1	Ø2	Ud./Caja	€/Ud.
616469	400	225	1	7.859,75
616779	400	250	1	8.261,28
616780	450	225	1	7.859,75
616781	450	250	1	6.766,90
616391	500	225	1	6.897,00
616782	500	250	1	7.188,97
616783	500	280	1	7.515,16
616784	500	315	1	7.723,93
616392	560	225	1	6.304,38
616785	560	250	1	6.304,38
616786	560	280	1	6.304,38
616787	560	315	1	6.304,38
616788	560	355	1	6.721,90
616789	560	400	1	8.141,44
616393	630	225	1	6.408,77
616790	630	250	1	6.408,77
616791	630	280	1	6.408,77
616792	630	315	1	6.408,77
616793	630	355	1	6.813,47
616794	630	400	1	8.308,43
616394	710	225	1	6.554,89
616795	710	250	1	6.554,89
616796	710	280	1	6.554,89
616797	710	315	1	5.899,40
616798	710	355	1	6.275,16
616762	710	400	1	8.350,18
616395	800	225	1	6.554,89
616799	800	250	1	6.659,29
616800	800	280	1	6.659,29
616801	800	315	1	6.659,29

Ref.	Ø1	Ø2	Ud./Caja	€/Ud.
616802	800	355	1	7.076,80
616803	800	400	1	8.767,69
616396	900	225	1	6.926,48
616804	900	250	1	6.784,55
616805	900	280	1	6.784,55
616806	900	315	1	6.784,55
616807	900	355	1	7.306,41
616808	900	400	1	9.602,72
616397	1000	225	1	6.554,89
616809	1000	250	1	6.972,41
616810	1000	280	1	6.972,41
616811	1000	315	1	7.494,29
616812	1000	355	1	7.911,80
616813	1000	400	1	10.020,22
616384	1200	225	1	7.306,41
616814	1200	250	1	7.306,41
616815	1200	280	1	7.306,41
616816	1200	315	1	7.807,41
616817	1200	355	1	8.350,18
616818	1200	400	1	10.855,23

PE 100 SDR17 Presión de servicio máxima admisible 10 bar (agua)/5 bar (gas)

Ref.	Ø1	Ø2	Ud./Caja	€/Ud.
616378	1000	160	1	6.179,14
616383	1200	160	1	6.596,64

* Para otras dimensiones consultar SA UNI



Aplicación



SA-TL UNI- TOMAS SIMPLES SA-UNI

PE 100 SDR11 Presión de servicio máxima admisible 16 bar (agua)/10 bar (gas)

Ref.	Ø1	Ø2	Ud./Caja	€/Ud.
616553	250-280	90	5	151,05
616554	250-280	110	5	164,45
616555	250-280	125	5	175,57
616556	250-280	160	5	160,24
616557	315-400	90	5	162,74
616558	315-400	110	5	155,39
616559	315-400	125	5	184,69
616560	315-400	160	5	150,34
616561	450-900	90	5	172,23
616562	450-900	110	5	159,06
616563	450-900	125	5	201,53
616564	● 450-900	160	5	185,71

Las tomas simples SA-TL-UNI pueden ser soldadas en tuberías SDR11 a SDR17,6



Aplicación



DAA-TL - TOMAS EN CARGA TOP-LOADING CON DERIVACIÓN EXTRA LARGA

PE 100 SDR11 Presión de servicio máxima admisible 16 bar (agua)/10 bar (gas)

Ref.	Ø1	Ø2	Ø3	Ud./Caja	€/Ud.
615527	080/130	50	50	20	187,25
615528	130/160	50	50	12	216,54
615531	160/210	63	50	5	221,29
615339	250/315(400)	63	50	5	310,76

Las tomas en carga DAA-TL pueden ser soldadas en tubos SDR11 a SDR17,6 desde Ø 250 a Ø 315
Para tubos mayores a Ø 315 sólo en SDR17



Aplicación



DAA - TOMAS EN CARGA CON DERIVACIÓN EXTRA LARGA

*PE 100 SDR11 Presión de servicio máxima
admisible 16 bar (agua)/10 bar (gas)*

Ref.	Ø1	Ø2	Ø3	Ud./Caja	€/Ud.
612630	40	20	50	30	45,09
616473	40	25	50	30	45,09
616474	40	32	50	30	41,31
616475	50	20	50	28	58,37
612702	50	25	50	28	56,10
615080	50	32	50	28	56,10
612631	63	20	50	20	59,58
612633	63	25	50	20	59,58
612632	63	32	50	20	47,02
616334	63	63	50	20	59,30
616482	75	32	50	24	68,54
616483	90	20	50	14	75,47
616484	90	25	50	14	69,21
612634	90	32	50	14	58,64
612701	90	63	50	14	61,21
616487	110	20	50	14	68,06
616488	110	25	50	14	68,06
612637	110	32	50	14	66,31
612624	110	63	50	14	64,97
616491	125	20	50	12	90,86
616492	125	25	50	12	90,86
612649	125	32	50	12	90,86
612309	125	63	50	12	85,72
616495	140	32	50	12	114,56
616496	140	63	50	12	118,46
616497	160	20	50	10	80,45
616498	160	25	50	10	80,45
612641	160	32	50	10	78,15
612650	160	63	50	10	78,32
616501	180	20	50	10	90,43
616502	180	25	50	10	90,43
612651	180	32	50	10	90,43
612652	180	63	50	10	90,43
612654	200	32	50	8	96,40
612659	200	63	50	8	92,81
612657	225	32	50	8	130,69
612655	225	63	50	8	130,69

Las tomas en carga DAA pueden ser soldadas en tuberías SDR11 a SDR17,6

*Excepto las ≤ DN 63 que solo pueden serlo con SDR11



Aplicación



DAV - TOMAS EN CARGA CON VÁLVULA DE CORTE INCORPORADA CON DERIVACIÓN EXTRA LARGA

PE 100 SDR11 Presión de servicio máxima admisible 16 bar (agua)/10 bar (gas)

Ref.	Ø1	Ø2	Ud./Caja	€/Ud.
615955	50*	32	16	148,59
615341	63*	32	16	133,65
615342	63*	40	16	141,46
615956	75	32	12	156,20
615344	90	32	12	176,24
615346	90	50	12	178,53
615347	90	63	12	180,58
615348	110	32	10	165,92
615350	110	50	10	167,01
615351	110	63	10	170,26
615352	125	32	10	178,32
615354	125	50	10	178,70
615355	125	63	10	178,91
615930	140	63	6	183,25
615356	160	32	6	211,60
615358	160	50	6	210,55
615359	160	63	6	213,27
615361	180	32	5	213,51
615363	180	50	5	214,33
615364	180	63	5	214,57
615366	200	32	5	212,93
615368	200	50	5	249,54
615369	200	63	5	214,33
615374	225	32	5	211,85
615376	225	50	5	212,89
615377	225	63	5	212,89

Las tomas DAV pueden ser soldadas en tuberías SDR11 a SDR17,6

* Excepto las ≤ DN 63 que solo pueden serlo con SDR11



Aplicación



DAV-TL - TOMAS EN CARGA TOP LOADING CON VÁLVULA DE CORTE INCORPORADA CON DERIVACIÓN EXTRA LARGA

PE 100 SDR11 Presión de servicio máxima admisible 16 bar (agua)/10 bar (gas)

Ref.	Ø1	Ø2	Ud./Caja	€/Ud.
616464	250/315	50	10	256,42
616465	355/400	50	10	269,25

Las tomas DAV-TL pueden ser soldadas en tuberías SDR11 a SDR17,6



Aplicación



FIXBLOC - FIJACIÓN EN TUBERÍAS PARA ABSORBER FUERZAS DE EMPUJE Y TRACCIÓN AXIAL .

Uso universal en tubería de PE 100 (SDR33 hasta SDR11)

Ref.	Ø	Ud./Caja	€/Ud.
680600	160-1600	15	101,34



Aplicación



PUDDLE-FLANGE - COLLARÍN DE GOMA PARA PARED

De gran flexibilidad, para el sellado hidrostático de tuberías de plástico (PE, PP, PVC, ABS, PVDF, etc.) en estructuras de hormigón (5 bares hasta D315, 4 bares desde D355)

Ref.	Ø	Ud./Caja	€/Ud.
101100004	32	1	46,12
101100005	40	1	46,12
101100006	50	1	46,12
101100007	63	1	47,68
101100008	75	1	52,15
101100009	90	1	54,52
101100010	110	1	58,95
101100011	125	1	63,22
101100012	140	1	64,50
101100013	160	1	64,80
101100014	180	1	67,12
101100015	200	1	68,29
101100016	225	1	70,58
101100017	250	1	72,19
101100018	280	1	75,52
101100019	315	1	95,54
101100020	355	1	129,88
101100021	400	1	155,52
101100022	450	1	163,66
101100023	500	1	183,01
101100024	560	1	200,12
101100025	630	1	219,35
101100027	710	1	241,66
101100028	800	1	268,04
101100029	900	1	320,33
101100030	1000	1	376,47
101100031	1200	1	444,14



Aplicación



KH - VÁLVULAS DE BOLA EN PE-AD, ¼ DE VUELTA. PASO TOTAL.

PE 100 SDR11 Presión de servicio máxima admisible 16 bar (agua)/10 bar (gas)

Ref.	Ø	Ud./Caja	€/Ud.
616470	20	1	130,33
616471	25	1	130,33
616176	32	1	125,69
616177	40	1	98,72
616178	50	1	128,36
616179	63	1	169,57
616180	90	1	446,60
616181	110	1	491,25
616182	125	1	326,02



KHP-GAS - VÁLVULAS DE BOLA EN PE-AD, ¼ DE VUELTA PARA GAS. PASO REDUCIDO.

PE 100 SDR11 Presión de servicio máxima admisible 10 bar (gas)

Ref.	Ø	Ud./Caja	€/Ud.
612490GPL	32	1	77,22
612494GPL	63	1	170,69
612495GPL	90	1	248,57



Aplicación



KHP - VÁLVULAS DE BOLA EN PE-AD, ¼ DE VUELTA. PASO REDUCIDO.

PE 100 SDR11 Presión de servicio máxima admisible 16 bar (agua)/10 bar (gas)

Ref.	Ø	Ud./Caja	€/Ud.
612490	32	1	72,48
612497	40	1	89,19
612492	50	1	125,22
612494	63	1	138,61
612495	90	1	207,12
612493	110	1	268,33
612496	125	1	317,64
612483	160	1	787,15
615309	180	1	752,06
612480	200	1	1.504,12
616186	225	1	1.532,17



Aplicación



NOVEDAD

FRIALOC - VALVULA EN PE-AD PARA AGUA. PASO TOTAL.

PE 100 SDR11 Presión de servicio máxima admisible 16 bar (agua)

Ref.	Ø	Ud./Caja	€/Ud.
616293	90	1	1.087,67
616294	110	1	1.087,67
616295	125	1	1.094,12
616296	160	1	1.710,17
616297	180	1	1.746,06
616453*	200	1	2.111,63
616298*	225	1	2.167,20
616438*	250	1	2.273,74

*Para diámetros a partir de 200mm el paso está restringido a d180 mm



Aplicación



KHPV-GAS - VÁLVULAS DE ESFERA EN PE-AD, ¼ DE VUELTA, CON VENDEOS, PARA GAS. PASO REDUCIDO.

PE 100 SDR11 Presión de servicio máxima admisible 10 bar (gas)

Ref.	Descripción	Ø - Venteos	Ud./Caja	€/Ud.
KHP0VE063GPL	Sin venteos	63-0VE	1	264,35
KHP1VE063GPL	Con un venteo	63-1VE	1	632,98
KHP2VE063GPL	Con dos venteos	63-2VE	1	952,00



Aplicación



BS - SETS DE ACCIONAMIENTO PARA KH,KHP, AKHP Y AKHP-TL

PE 100 SDR11 Presión de servicio máxima admisible 16 bar (agua)/10 bar (gas)

Ref.	Ø Tubo	Longitud (mm)	Ud./Caja	€/Ud.
615741	20-50	0,45 - 0,70	1	101,83
615957	20-50	0,60 - 1,00	1	110,26
615328	20-50	0,60 - 1,00	1	104,66
616466	20-50	1,00 - 1,50	1	113,06
615330	20-50	1,00 - 1,50	1	113,06
616068	20-50	1,20 - 2,00	1	117,70
615329	20-50	1,20 - 2,00	1	115,78
615958	63-225	0,60 - 1,00	1	124,26
615310	63-225	0,60 - 1,00	1	117,61
616467	63-225	1,00 - 1,50	1	127,04
615331	63-225	1,00 - 1,50	1	127,04
616069	63-225	1,20 - 2,00	1	140,59
615311	63-225	1,20 - 2,00	1	139,69

Máquinas de soldadura
Rascadores
Accesorios y herramientas



Equipos y herramientas Friatools

INFRAESTRUCTURA





Más información



FRIAMAT BASIC ECO
MÁQUINA UNIVERSAL DE SOLDADURA
SIN FUNCIÓN DE DOCUMENTACIÓN

Ref.	Descripción	€/Ud.
613120	Friamat basic eco con lápiz lector de código de barras	3,629.69
614120	FRIAMAT basic eco 2D	5,369.04
611120	Friamat basic eco con mini escáner lector de código de barras	4,180.58

Unidad de fusión universal para la unión de accesorios de DN 20 a DN 900. Compartimento de almacenamiento para accesorios, opción de lector código de barras o escáner para el reconocimiento de códigos de barras. Teclado de fácil manejo. Selección de idiomas, volumen de timbre ajustable, e introducción manual de notas.

Cable de conexión (4 m) y cable de red (5 m) extra largos. Peso aproximado 18 kg.

Suministrado en una práctica caja de aluminio de protección para el transporte.



FRIAMAT PRIME ECO
MÁQUINA UNIVERSAL DE
SOLDADURA CON FUNCIÓN DE
DOCUMENTACIÓN Y TRAZABILIDAD

Ref.	Descripción	€/Ud.
613124	Friamat prime eco con lápiz lector de código de barras	4,519.15
614124	FRIAMAT prime eco 2D	5,485.41
611124* ●	Friamat prime eco con mini escáner lector de código de barras	4,729.39

Unidad de fusión para la soldadura mediante accesorios de electrofusión de tubos de cualquier tamaño (hasta DN 900). Fácil guía de usuario con un gran display, maxi-guía y modernos interfaces: Puertos USB (A + B) para la transmisión de datos a través de tarjeta de memoria FRIATEC (incluida); para la conexión de impresoras, volcado de datos y de documentos PDF. Puerto paralelo para conexión a impresora y PC.

Contraseña de supervisor para el ajuste individual de las funciones del dispositivo.

Posibilidad de introducir coordenadas GPS, e introducir información a través de textos de código de barras, con lápiz lector o escáner de código de barras (opcional).

Selección de idiomas, volumen de timbre ajustable, e introducción manual de notas. Cable de conexión (4 m) y cable de red (5 m) extra largos.

Peso aproximado 18 kg.

Suministrado en una práctica caja de aluminio de protección para el transporte.

* Consultar promociones vigentes para modelo "FRIAMAT prime eco con mini escáner"

App en castellano disponible

AVAILABLE ON THE Google Play

AVAILABLE ON THE App Store





FRIAMAT PRINT ECO
MÁQUINA UNIVERSAL DE SOLDADURA
CON FUNCIÓN DE DOCUMENTACIÓN

Ref.	Descripción	€/Ud.
613122	Friamat print eco con lápiz lector de código de barras	4,405.35
611122	Friamat print eco con mini escáner lector de código de barras	4,598.15

Unidad de fusión universal para la unión de accesorios de DN20 a DN1200.

Puerto USB para la transmisión de datos para la conexión a impresora de datos y de documentación PDF

Selección de idiomas, volumen de timbre ajustable e introducción manual de notas. Cable de conexión (4 m) y cable de red (5 m) extra largos.

Peso aproximado 18 kg.

Suministrada en una práctica caja de aluminio de protección para el transporte



FRIAMAT 7 PRIME

Ref.	Descripción	€/Ud.
613134	FRIAMAT 7 Gen. prime	5,529.18
611134*	FRIAMAT 7 Gen. prime Mini Escaner	5,780.48
614134	FRIAMAT 7 Gen. prime 2D	6,489.63

FRIAMAT prime ofrece una gran cantidad de funciones digitales para la documentación y la trazabilidad, gracias a la nueva interfaz Bluetooth en combinación con la aplicación FRIAMAT. Con el escáner 1D/2D opcional, la nueva generación de FRIAMAT también está preparada para leer y procesar códigos de barras 2D según ISO 12176-5.

Su pantalla de alto brillo y contraste es fácil de leer, tanto en días soleados como en días oscuros y lluviosos.

Convierte tu teléfono en el centro de control de todo lo relacionado con la soldadura. Simplemente conecta tu unidad FRIAMAT prime a la aplicación FRIAMAT APP a través de Bluetooth. Después podrás controlar el proceso de fusión con tu teléfono. Los datos del proceso de fusión se transfieren automáticamente a la aplicación.

* Consultar promociones vigentes para modelo "FRIAMAT 7 Gen. prime Mini Escaner"



FRIAMAT 7 BASIC

Ref.	Descripción	€/Ud.
613130	FRIAMAT 7 Gen. Basic	5,406.39
611130	FRIAMAT 7 Gen. basic Mini Escaner	5,585.99
614130	FRIAMAT 7 Gen. basic 2D	6,366.84

FRIAMAT basic es nuestro modelo básico por excelencia, cada vez con más prestaciones: refrigeración activa con flujo optimizado, carcasa robusta, pantalla gráfica de alta calidad, interfaz de usuario intuitiva y mucho más.



NUEVO ESCÁNER LECTOR DE CÓDIGOS DE BARRAS

Ref.	Descripción	€/Ud.
624005	Mini escáner	606,63



FWLESST - LÁPIZ LECTOR DE CÓDIGO DE BARRAS

Ref.	Descripción	€/Ud.
623645 ●	Lápiz lector	424,54

Lápiz lector de códigos de barras FRIAMAT apto para leer los códigos de soldadura y de trazabilidad.
 Apto para todos los equipos de soldadura FRIAMAT.



CONTACT 4 - BORNES DE CONEXIÓN DE 4,0 MM

Ref.	Descripción	€/Par.
624529	Bornes de 4,0 mm	94,10

Para la conexión al accesorio de soldadura en toda nuestra gama FRIAMAT.
 Estos conectores se venden por unidad.



ADBK - ADAPTADORES PARA BORNES DE 4,7 MM

Ref.	Descripción	€/Par
613237	Adaptadores de bornes	180,39

Adaptador para bornes de 4,7 mm para cualquier tipo de FRIAMAT.
 Estos conectores se venden por pares.



ALTK (FMT) - CAJA DE ALUMINIO PARA TRANSPORTE

Ref.	Descripción	€/Ud.
627600	Caja de transporte para nuevas FRIAMAT prime / basic	521,17
627001	Caja de transporte para antiguas FRIAMAT prime / basic	521,17
627001	Caja de transporte para FRIAMAT prime eco / basic eco	521,17
613302	Caja de transporte para FRIAMAT XL	642,18

Para el transporte y el almacenamiento de equipos de soldadura FRIAMAT. Otras cajas de transporte para equipos más antiguos FRIAMAT (I-II) bajo consulta.



FWGS 63 - RASCADOR PARA TUBOS DESDE DN 20 HASTA DN 63

Ref.	Descripción	€/Ud.
613408	Rascador para tubos DN 20 a DN 63	1.800,05

Para eliminar de forma segura la capa de óxido de las tuberías de HDPE y PE-XA.
Cuchilla extra ancha de metal duro.
Incluye 1 cuchilla de repuesto.
Suministrado en una práctica caja de aluminio de protección para el transporte.



FWGS 225 - RASCADOR PARA TUBOS DESDE DN 75 HASTA DN 400

Ref.	Descripción	€/Ud.
613410	Rascador para tubos DN 75 a DN 400	2.527,86

Para eliminar de forma segura la capa de óxido de las tuberías de HDPE y PE-XA.
Cuchilla extra ancha de metal duro.
Incluye 1 cuchilla de repuesto.
Suministrado en una práctica caja de aluminio de protección para el transporte.



FWSG 710 L - RASCADOR PARA TUBOS DESDE DN 250 HASTA DN 710

Ref.	Descripción	€/Ud.
613642	Rascador para tubos DN 250 a DN 710	4.573,11

Para eliminar de forma segura la capa de óxido de las tuberías de HDPE y PE-Xa a la mitad o completo. Rascador de gran longitud. Cuchilla con hoja de carburo para una larga duración y raspado uniforme. Suministrado en una práctica caja de aluminio de protección para el transporte



FWSG 710 S - RASCADOR PARA TUBOS DESDE DN 250 HASTA DN 710 Y ACCESORIOS A TOPE

Ref.	Descripción	€/Ud.
613639	Rascador para tubos DN 250 a DN 710 y accesorios a tope	4.573,11

Para eliminar de forma segura la capa de óxido de las tuberías de HDPE y PE-Xa a la mitad o completo y para el raspado seguro de piezas y tubos que van a ser soldados a testa. Rascador de gran longitud. Cuchilla con hoja de carburo para una larga duración y raspado uniforme. Suministrado en una práctica caja de aluminio de protección para el transporte.



WSG 900 L - RASCADOR PARA TUBOS DESDE DN 630 HASTA DN 900

Ref.	Descripción	€/Ud.
613644	Rascador para tubos desde DN 630 a DN 900	10.281,39

Para eliminar de forma segura la capa de óxido de las tuberías de HDPE y PE-Xa a la mitad o completo y para el raspado seguro de piezas y tubos que van a ser soldados a testa. Rascador de gran longitud. Cuchilla con hoja de carburo para una larga duración y raspado uniforme. Suministrado en una práctica caja de aluminio de protección para el transporte.

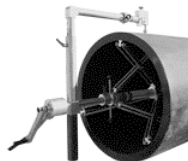

FWSG XL - RASCADOR PARA TUBOS DESDE DN 800 HASTA DN 1200

Ref.	Descripción	€/Ud.
613645	Rascador para tubos DN 800 a DN 1200	25.298,06

Para eliminar de forma segura la capa de óxido en las tuberías de PE-AD en diámetros desde 800 a 1200, SDR11 - SDR33. Diseño modular para un fácil manejo y rápida instalación. Ajuste rápido y seguro al ancho del tubo. Montaje central, accionamiento mediante manivela. Compensación automática de la ovalidad de tubería y tolerancias mediante una cuchilla alojada en muelle móvil. Cuchilla reversible para doblar la duración. Suministrado en una práctica caja de aluminio de protección para el transporte.



FWSG 63 - RASCADOR PARA TUBOS DESDE DN 63 A DN 315

Ref.	Ø	Descripción	€/Ud.
613562	DN 63	FWSG SE 63	1.573,03
613563	DN 75	FWSG SE 75	1.608,89
613564	DN 90	FWSG SE 90	1.663,83
613565	DN 110	FWSG SE 110	1.690,35
613566	DN 125	FWSG SE 125	1.864,92
613567	DN 140	FWSG SE 140	1.957,44
613568	DN 160	FWSG SE 160	1.864,92
613569	DN 180	FWSG SE 180	2.114,66
613570	DN 200	FWSG SE 200	2.173,52
613571	DN 225	FWSG SE 225	2.236,84
613572	DN 250	FWSG SE 250	2.331,96
613573	DN 280	FWSG SE 280	2.380,33
613574	DN 315	FWSG SE 315	2.450,78

Rascador para extremos de tubos y tomas simples y en carga. Dimensionado para cada diámetro para un raspado seguro y libre de óxido. Se usa en tuberías PE-AD y PE-XA.

Cuchillas reversibles para doblar la duración. Fácil fijación gracias al diseño de apertura y cierre.

Suministrado en una práctica caja de aluminio de protección para el transporte.



PFSP - SPRAY DE ACEITE PARA EL MANTENIMIENTO DE LOS RASCADORES DE FRIATEC

Ref.	Descripción	€/Ud.
613301	Spray de mantenimiento FRIATEC	36,33

Para la limpieza y el mantenimiento de rascadores. Contenido 100 ml. Observe con atención las instrucciones de seguridad y utilización indicadas en el recipiente del spray de mantenimiento, y a las pertinentes instrucciones de uso de las rascadores.



FWSG RA - CUCHILLAS DE REPUESTO PARA RASCADORES

Ref.	Descripción	€/Ud.
613322 (1)	FWSGE 3. Cuchillas para FWSG 225/315 Y FWSGA. Pintadas de color rojo	362,60
613323 (1)	FWSGE 4. Cuchillas para FWSG 63. Pintadas de color verde	364,25
613324 (1)	FWSGE 5. Cuchillas para FWSG 710 L/S / FWSG 900 L. Pintadas de color azul	367,31
613325 (2)	FWSGE 6. Cuchillas para FWSGS 110 / FWSGS 180	368,42
613326 (2)	FWSGE 7. Cuchillas para FWSGS 225	370,43

(1) Integrado por 3 unidades de cuchillas de repuesto, 1 tornillo de cabeza de estrella y 1 llave cabeza estrella.

(2) Integrado por 1 unidad de cuchillas de repuesto, 2 tornillos de cabeza de estrella y 1 llave cabeza estrella.



Ref.	Descripción	€/Ud.
613327 (3)	FWSGE 8. Cuchillas para FWSG SE (todos los DN)	251,69

(3) Integrado por 1 unidad de cuchillas de repuesto, 1 tornillo de cabeza de estrella y 1 llave cabeza estrella.



Ref.	Descripción	€/Ud.
613329 (4)	FWSGE 10. Cuchillas para FWSG RA 32 y 40	171,25
613330 (4)	FWSGE 11. Cuchillas para FWSG RA 50 y 63	172,09

(4) Integrado por 1 unidad de cuchillas de repuesto, 1 tornillo de cabeza de estrella y 1 llave cabeza estrella.



Ref.	Descripción	€/Ud.
613331 (5)	FWSGE 12. Cuchillas para FWSG XL	695,04

(5) Integrado por 1 unidad de cuchillas de repuesto, 1 placa de deslizamiento. 2 tornillos de cabeza de estrella y 1 llave cabeza de estrella.

Cuchillas de repuesto de metal duro (alta estabilidad, larga duración)



ALTK (FWSG) - CAJA DE ALUMINIO PARA EL TRANSPORTE DE LOS RASCADORES FRIATEC

Ref.	Descripción	€/Ud.
613307	ALTK FWSG 63	87,86
613309	ALTK FWSG 225 Y 63/225	211,92
613308	ALTK FWSG 710 S	400,46
613314	ALTK FWSG 710 L	400,46
613304	ALTK FWSG 900 L	426,75
613303	ALTK FWSG SE 63	202,58
613319	ALTK FWSG SE 75-140	226,50
613318	ALTK FWSG SE 160	233,51
613320	ALTK FWSG SE 250-315	342,70

Para transportar y almacenar rascadores.



FWZ - RASCADOR MANUAL

Ref.	Descripción	€/Ud.
613300	Rascador manual	50,88
613270	Cuchillas de repuesto 1 ud.	37,27

Para la eliminación de la capa de óxido de las tuberías de PE – AD y accesorios, así como para desbarbar el canto cortado.

Cuchillas de repuesto en pack de 5 uds.

FWZ - RASCADOR MANUAL

Ref.	Descripción	€/Ud.
613299	Rascador manual gran Ø	256,53

Para eliminar la capa de óxido de tubos de PE de gran diámetro, que no pueden ser rascados con rascadores convencionales.

Sirve especialmente para la preparación de las superficies de unión con tomas simples del tipo FRIALEN XL. También es apto para quitar las rebabas de bordes cortados.

Dispone de dos superficies de corte.



FRIATOP - DISPOSITIVO DE FIJACIÓN (TOP LOADING)

Ref.	Descripción	€/Ud.
613350	Dispositivo Top Loading	3.324,41

Dispositivo de fijación, presión y colocación para el montaje de las tomas simples y en carga FRIALEN Top Loading. No requiere fijación inferior. Accionamiento con muelle neumático extra elástico para una óptima presión durante el proceso de fusión.



PRESSKO - ÉMBOLO PARA LAS TOMAS EN CARGA FRIALEN XL Y SA-XL

Ref.	Dimensión émbolo	Descripción	€/Ud.
613821	DN 160	Émbolo para FRIALEN SA-XL	536,36
613822	DN 225	Émbolo para FRIALEN SA-XL	676,54
613823	DN 250	Émbolo para FRIALEN SA-XL	778,54
613853	DN 280	Émbolo para FRIALEN SA-XL	1.028,52
613854	DN 315	Émbolo para FRIALEN SA-XL	1.130,90
613855	DN 355	Émbolo para FRIALEN SA-XL	1.198,45
613837	DN 400	Émbolo para FRIALEN SA-XL	2.780,78

Émbolo de fijación y conexión del Vacuset XL con salida DN 160 a DN 400



FWAB XL - BROCA DE PERFORACIÓN FWAB XL PARA SA-XL

Ref.	Descripción	DN de la salida	€/Ud.
613832	FWAB XL 90	DN 90	2.299,87
613833	FWAB XL 110	DN 110	2.379,87
613834	FWAB XL 125	DN 125	2.448,44
613829	FWAB XL 160 SDR11	DN 160	2.614,14
613838	FWAB XL 160 SDR17	DN 160	2.914,13
613830	FWAB XL 225	DN 225	2.928,42
613831	FWAB XL 250	DN 250	3.251,25
613850	FWAB XL 280	DN 280	3.931,19
613851	FWAB XL 315	DN 315	4.171,20
613852	FWAB XL 355	DN 355	4.171,20
613836	FWAB XL 400	DN 400	4.190,23

FWAB XL para la perforación de tubos de PE-AD. Con sistema de despresurización a través de la salida de los accesorios SA-XL. Consistente en una sierra cortante del DN elegido, un adaptador SDS max, extensión para el adaptador, broca central y cavidad para alojamiento de la viruta. Se debe utilizar un taladro eléctrico. Se entrega en un maletín de aluminio.



UNITOP - DISPOSITIVO DE FIJACIÓN PARA LAS TOMAS SIMPLES SA-UNI

Ref.	Descripción	€/Ud.
613385	Dispositivo de fijación para tomas simples Frialen SA-UNI	5.713,96
613241	Adaptadores en ángulo para conexiones por socket 4.0 mm	76,58

Dispositivo de fijación para las tomas de derivación simple SA-UNI DN 250 a DN 710 con salidas DN 90, DN110, DN 125 y DN 160. Se suministra en un maletín de aluminio.

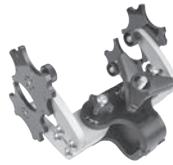

CLAMP 63 - ALINEADOR PARA TUBOS DESDE DN 20 HASTA DN 63

Ref.	Descripción	€/Ud.
613020	Alineador para tubos DN 20 a DN63	579,90
613034	Alineador para tubos DN 32 a DN63 para instalación con FRIALONG	917,59

Alineador universal con ajuste de ángulo (45° y 90°), para manguitos, reducciones y salidas en accesorios de toma de derivación electrosoldable desde DN 20 a DN 63.

Opcional: versión CLAMP63L para instalaciones de manguitos extra largos FRIALONG.



CLAMP 180 - ALINEADOR PARA TUBOS DESDE DN 63 HASTA DN 180

Ref.	Descripción	€/Ud.
613021	Alineador con dos elementos fijadores	1.425,18
613022	Elemento fijador adicional	284,31
613023	Set de medias lunas reductoras DN 110-DN 160	99,75
613024	Extensión en forma de Té	1.121,88

Alineador con ajuste de ángulo (45° y 90°), y dos elementos fijadores para manguitos, reducciones y codos de DN 63, DN 90, DN 125 y DN180.

Se pueden acoplar medias lunas reductoras para crear diferentes configuraciones. Se suministra en una práctica bolsa.

El alineador se puede expandir con elementos fijadores adicionales para uso cuádruple de DN 63, DN 90, DN 125 y DN 160. Se necesitarían dos alineadores adicionales.

Disponible elemento de extensión en Té para fijación y alineación. Variante con un solo alineador. Elementos fijadores adicionales pueden acoplarse para fijación doble en acometidas.

Medias lunas de reducción para DN 110 y DN 160. Se necesita un juego de media luna para cada elemento fijador.



SQM 63 Y 125 - PINZADOR PARA TUBOS DESDE DN 20 HASTA DN 125

Ref.	Descripción	DN	SDR	€/Ud.
613025 ●	Pinzador SQM 63	DN 20 a DN 63	SDR 11	270,31
613026	Pinzador SQM125	DN 63 a DN 90	SDR 11	641,31
613026	Pinzador SQM125	DN 90 a DN 125	SDR 17,6	641,31

Pinzador para corte temporal en tubos de PE-AD y PE-Xa en DN 63 a DN 125 en SDR 11 y SDR 17,6.

Cumple con la DVGW GW 332.



VACUPUMP - BOMBA DE VACÍO PARA UTILIZACIÓN EN OBRA PARA SA-XL Y RS-XL

Ref.	Descripción	€/Ud.
613827	Bomba de vacío 230 V	3.798,77

Para la instalación de derivaciones Frialen XL SA-XL y abrazaderas de reparación RS-XL.
 Se compone de bomba de vacío (110 V/230 V)manómetro y mangueras de conexión.
 No requiere compresor adicional para su funcionamiento.
 Se suministra en un maletín de aluminio.



SQH 180 - PINZADOR HIDRÁULICO PARA TUBOS DESDE DN 63 HASTA DN 180

Ref.	Descripción	DN	SDR	€/Ud.
613028	Pinzador SQH180	DN 63 a DN 180	SDR 11 Y SDR 17,6	1.676,17

Pinzador para corte temporal en tubos de PE-AD y PE-Xa en DN 63 a DN 125 en SDR 11 y SDR 17,6.
 Cumple con la DVGW GW 332.



PRODUCTOS LIMPIADORES DE ÓXIDO ESPECÍFICOS PARA POLIETILENO

Ref.	Descripción	€/Ud.
614001	Bote limpiador 0,75 Litros	31,65
614002	Toallitas limpiadoras	40,60

Producto específico para una óptima limpieza y desoxidación del PE.
 Alta volatilidad, 99,9% alcohol.

Accesorios de PE



Accesorios de Polietileno inyectados largos

INFRAESTRUCTURA



**RDPE - REDUCCIÓN**

Con cuello largo para soldar con accesorios de alta seguridad FRIALEN, o soldadura a tope.

PE 100 SDR11 - Máxima presión de trabajo permitida 16 bar (agua) / 10 bar (gas)



Aplicación



Ref.	Ø	€/Ud.
RDPE11003225	32-25	3,42
RDPE11004020	40-20	5,00
RDPE11004025	40-25	5,00
RDPE11004032	40-32	5,00
RDPE11005025	50-25	5,30
RDPE11005032	50-32	5,81
RDPE11005040	50-40	5,81
RDPE11006332	63-32	8,03
RDPE11006340	63-40	8,03
RDPE11006350	63-50	8,03
RDPE11007540	75-40	12,27
RDPE11007550	75-50	21,89
RDPE11007563	75-63	21,89
RDPE11009050	90-50	15,86
RDPE11009063	90-63	15,86
RDPE11009075	90-75	15,86
RDPE11011063	110-63	19,03
RDPE11011075	110-75	19,03
RDPE11011090	110-90	17,09
RDPE11012563	125-63	27,00
RDPE11012575	125-75	27,00
RDPE11012590	125-90	27,00
RDPE11125110	125-110	27,00
RDPE11014075	140-75	36,96
RDPE11014090	140-90	36,96
RDPE11140110	140-110	36,96
RDPE11140125	140-125	36,96
RDPE11016090	160-90	52,01
RDPE11160110	160-110	52,01
RDPE11160125	160-125	52,01
RDPE11160140	160-140	52,01

Ref.	Ø	€/Ud.
RDPE11180125	180-125	58,15
RDPE11180160	180-160	63,26
RDPE11200125	200-125	63,91
RDPE11200160	200-160	61,41
RDPE11225110	225-110	118,08
RDPE11225160	225-160	118,08
RDPE11225180	225-180	118,08
RDPE11250160	250-160	160,46
RDPE11250180	250-180	167,92
RDPE11250200	250-200	167,92
RDPE11250225	250-225	167,92
RDPE11280180	280-180	208,67
RDPE11280200	280-200	208,67
RDPE11280225	280-225	208,67
RDPE11280250	280-250	200,96
RDPE11315225	315-225	287,79
RDPE11315250	315-250	287,79
RDPE11315280	315-280	287,79
RDPE11355250	355-250	605,25
RDPE11355280	355-280	605,25
RDPE11355315	355-315	605,25
RDPE11400280	400-280	641,32
RDPE11400315	400-315	641,32
RDPE11400355	400-355	641,32
RDPE11450400	450-400	690,35
RDPE11500355	500-355	826,50
RDPE11500400	500-400	861,02
RDPE11500450	500-450	930,10
RDPE11630400	630-400	1.310,29
RDPE11630450	630-450	1.339,64
RDPE11630500	630-500	1.346,70

Para otras medidas, diámetros y tipo de accesorios, consultar.



Aplicación



PE 100 SDR17 - Máxima presión de trabajo permitida 10 bar (agua) / 5 bar (gas)

Ref.	Ø	€/U..
RDPE17007540	75-40	12,27
RDPE17007563	75-63	15,60
RDPE17009050	90-50	16,92
RDPE17009063	90-63	16,92
RDPE17009075	90-75	16,92
RDPE17011063	110-63	14,82
RDPE17011075	110-75	14,82
RDPE17011090	110-90	12,60
RDPE17012563	125-63	27,00
RDPE17012575	125-75	27,00
RDPE17012590	125-90	27,00
RDPE17125110	125-110	27,00
RDPE17014075	140-75	38,79
RDPE17014090	140-90	38,79
RDPE17140110	140-110	38,79
RDPE17140125	140-125	38,79
RDPE17016090	160-90	52,01
RDPE17160110	160-110	52,01
RDPE17160125	160-125	52,01
RDPE17160140	160-140	52,01
RDPE17180125	180-125	58,15
RDPE17180160	180-160	63,26
RDPE17200125	200-125	54,48
RDPE17200160	200-160	49,71
RDPE17225110	225-110	118,08
RDPE17225160	225-160	118,08
RDPE17225180	225-180	118,08

Ref.	Ø	€/Ud.
RDPE17250160	250-160	167,92
RDPE17250180	250-180	167,92
RDPE17250200	250-200	167,92
RDPE17250225	250-225	167,92
RDPE17280180	280-180	208,67
RDPE17280200	280-200	208,67
RDPE17280225	280-225	208,67
RDPE17280250	280-250	200,96
RDPE17315225	315-225	287,79
RDPE17315250	315-250	287,79
RDPE17315280	315-280	287,79
RDPE17355250	355-250	641,32
RDPE17355280	355-280	641,32
RDPE17355315	355-315	377,44
RDPE17400280	400-280	677,64
RDPE17400315	400-315	677,64
RDPE17400355	400-355	586,81
RDPE17450315	450-315	714,10
RDPE17450355	450-355	743,06
RDPE17450400	450-400	784,04
RDPE17500355	500-355	923,59
RDPE17500400	500-400	975,37
RDPE17500450	500-450	1.027,21
RDPE17630400	630-400	1.261,81
RDPE17630450	630-450	1.318,31
RDPE17630500	630-500	1.337,58

WWPE - CODO 30°

Con cuello largo para soldar con accesorios de alta seguridad FRIALEN, o soldadura a tope.



Aplicación



PE 100 SDR11 - Máxima presión de trabajo permitida 16 bar (agua) / 10 bar (gas)

Ref.	Ø	€/Ud.
WWPE1100075	75	25,43
WWPE1100090	90	37,05
WWPE1100110	110	54,84
WWPE1100125	125	90,09
WWPE1100140	140	98,65
WWPE1100160	160	126,13
WWPE1100180	180	180,69
WWPE1100200	200	226,89
WWPE1100225	225	282,18

PE 100 SDR17 - Máxima presión de trabajo permitida 10 bar (agua) / 5 bar (gas)

Ref.	Ø	€/Ud.
WWPE1700075	75	24,73
WWPE1700090	90	31,13
WWPE1700110	110	40,53
WWPE1700125	125	63,40
WWPE1700140	140	82,04
WWPE1700160	160	92,48
WWPE1700180	180	130,62
WWPE1700200	200	144,21
WWPE1700225	225	184,40

Para otras medidas, diámetros y tipo de accesorios, consultar.



Aplicación



HDPE - CODO 45°

Con cuello largo para soldar con accesorios de alta seguridad FRIALEN, o soldadura a tope.

PE 100 SDR11 - Máxima presión de trabajo permitida 16 bar (agua) / 10 bar (gas)

Ref.	Ø	€/Ud.
HDPE11000025	25	5,00
HDPE11000032	32	5,95
HDPE11000040	40	7,44
HDPE11000050	50	8,48
HDPE11000063	63	15,13
HDPE11000075	75	20,43
HDPE11000090	90	16,53
HDPE11000110	110	23,49
HDPE11000125	125	53,83
HDPE11000140	140	60,12
HDPE11000160	160	57,70
HDPE11000180	180	89,42
HDPE11000200	200	104,35
HDPE11000225	225	145,13
HDPE11000250	250	251,70
HDPE11000280	280	379,71
HDPE11000315	315	460,99
HDPE11000355	355	1.052,49
HDPE11000400	400	1.299,22
HDPE11000450	450	1.772,06
HDPE11000500	500	1.988,12

PE 100 SDR17 - Máxima presión de trabajo permitida 10 bar (agua) / 5 bar (gas)

Ref.	Ø	€/Ud.
HDPE17000063	63	6,26
HDPE17000075	75	18,47
HDPE17000090	90	15,72
HDPE17000110	110	22,28
HDPE17000125	125	48,56
HDPE17000140	140	59,59
HDPE17000160	160	44,29
HDPE17000180	180	79,79
HDPE17000200	200	83,98
HDPE17000225	225	130,57
HDPE17000250	250	216,53
HDPE17000280	280	326,75
HDPE17000315	315	406,57
HDPE17000355	355	758,22
HDPE17000400	400	1.138,24
HDPE17000450	450	1.340,29
HDPE17000500	500	1.572,35



Aplicación



GDPE - CODO 90°

Con cuello largo para soldar con accesorios de alta seguridad FRIALEN, o soldadura a tope.

PE 100 SDR11 - Máxima presión de trabajo permitida 16 bar (agua) / 10 bar (gas)

Ref.	Ø	€/Ud.
GDPE11000025	25	4,55
GDPE11000032	32	4,97
GDPE11000040	40	6,29
GDPE11000050	50	8,31
GDPE11000063	63	15,13
GDPE11000075	75	19,96
GDPE11000090	90	14,73
GDPE11000110	110	23,13
GDPE11000125	125	53,83
GDPE11000140	140	60,12
GDPE11000160	160	63,43
GDPE11000180	180	88,63
GDPE11000200	200	112,83
GDPE11000225	225	154,48
GDPE11000250	250	240,50
GDPE11000280	280	405,08
GDPE11000315	315	510,14
GDPE11000355	355	1.030,63
GDPE11000400	400	1.314,42
GDPE11000450	450	1.719,67
GDPE11000500	500	2.098,02

PE 100 SDR17 - Máxima presión de trabajo permitida 10 bar (agua) / 5 bar (gas)

Ref.	Ø	€/Ud.
GDPE17000063	63	6,62
GDPE17000075	75	18,07
GDPE17000090	90	14,79
GDPE17000110	110	24,90
GDPE17000125	125	48,56
GDPE17000140	140	59,59
GDPE17000160	160	53,33
GDPE17000180	180	79,79
GDPE17000200	200	102,41
GDPE17000225	225	130,57
GDPE17000250	250	215,24
GDPE17000280	280	324,84
GDPE17000315	315	406,71
GDPE17000355	355	841,52
GDPE17000400	400	1.025,61
GDPE17000450	450	1.304,76
GDPE17000500	500	1.684,49

Para otras medidas, diámetros y tipo de accesorios, consultar.



Aplicación



YEPE - Y 45°

Con cuello largo para soldar con accesorios de alta seguridad FRIALEN, o soldadura a tope.

PE 100 SDR11 - Máxima presión de trabajo permitida 16 bar (agua) / 10 bar (gas)

Ref.	Ø	€/Ud.
YEPE11000040	40	10,22
YEPE11000050	50	17,65
YEPE11000063	63	32,89
YEPE11000075	75	43,98
YEPE11000090	90	78,59
YEPE11000110	110	105,61
YEPE11000125	125	207,89
YEPE11000160	160	335,93
YEPE11000180	180	445,67
YEPE11000200	200	550,97
YEPE11000225	225	756,90
YEPE17000315	315	894,34

PE 100 SDR17 - Máxima presión de trabajo permitida 10 bar (agua) / 5 bar (gas)

Ref.	Ø	€/Ud.
YEPE17000040	40	5,33
YEPE17000050	50	16,78
YEPE17000063	63	28,26
YEPE17000075	75	40,42
YEPE17000090	90	84,96
YEPE17000110	110	75,98
YEPE17000125	125	190,15
YEPE17000160	160	317,85
YEPE17000180	180	418,05
YEPE17000200	200	494,70
YEPE17000225	225	713,00
YEPE17000315	315	730,52



Aplicación



TEPE - TE IGUAL 90°

Con cuello largo para soldar con accesorios de alta seguridad FRIALEN, o soldadura a tope.

PE 100 SDR11 - Máxima presión de trabajo permitida 16 bar (agua) / 10 bar (gas)

Ref.	Ø	€/Ud.
TEPE11000025	25	5,53
TEPE11000032	32	6,60
TEPE11000040	40	7,94
TEPE11000050	50	10,50
TEPE11000063	63	14,43
TEPE11000075	75	21,81
TEPE11000090	90	20,46
TEPE11000110	110	31,83
TEPE11000125	125	67,36
TEPE11000140	140	101,83
TEPE11000160	160	80,80
TEPE11000180	180	167,11
TEPE11000200	200	153,72
TEPE11000225	225	284,99
TEPE11000250	250	404,58
TEPE11000280	280	520,27
TEPE11000315	315	777,16
TEPE11000355	355	1.262,52
TEPE11000400	400	1.328,50
TEPE11000450	450	1.599,61
TEPE11000500	500	2.007,72

PE 100 SDR17 - Máxima presión de trabajo permitida 10 bar (agua) / 5 bar (gas)

Ref.	Ø	€/Ud.
TEPE17000063	63	11,11
TEPE17000075	75	18,89
TEPE17000090	90	22,87
TEPE17000110	110	30,42
TEPE17000125	125	57,23
TEPE17000140	140	87,01
TEPE17000160	160	73,31
TEPE17000180	180	142,19
TEPE17000200	200	131,21
TEPE17000225	225	241,96
TEPE17000250	250	242,94
TEPE17000280	280	332,53
TEPE17000315	315	462,56
TEPE17000355	355	1.179,92
TEPE17000400	400	1.054,18
TEPE17000450	450	1.232,43
TEPE17000500	500	1.864,71

Para otras medidas, diámetros y tipo de accesorios, consultar.



Aplicación

**TRPE - TE REDUCIDA 90°**

Con cuello largo para soldar con accesorios de alta seguridad FRIALEN, o soldadura a tope.

PE 100 SDR11 - Máxima presión de trabajo permitida 16 bar (agua) / 10 bar (gas)

Ref.	Ø	€/Ud.
TRPE11006332	63-32	29,53
TRPE11011063	110-63	51,59
TRPE11011090	110-90	33,60
TRPE11012563	125-63	77,86
TRPE11012575	125-75	77,86
TRPE11012590	125-90	77,86
TRPE11125110	125-110	77,86
TRPE11014063	140-63	117,57
TRPE11014075	140-75	102,08
TRPE11014090	140-90	117,57
TRPE11140110	140-110	121,81
TRPE11016063	160-63	140,95
TRPE11016075	160-75	123,30
TRPE11016090	160-90	142,04
TRPE11160110	160-110	145,72
TRPE11018075	180-75	201,91
TRPE11018090	180-90	201,91
TRPE11180110	180-110	201,91
TRPE11180125	180-125	201,91

Ref.	Ø	€/Ud.
TRPE11180140	180-140	196,04
TRPE11180160	180-160	196,04
TRPE11020063	200-63	256,14
TRPE11020075	200-75	256,14
TRPE11020090	200-90	256,14
TRPE11200110	200-110	181,37
TRPE11200125	200-125	256,14
TRPE11200160	200-160	256,14
TRPE11022563	225-63	316,51
TRPE11022575	225-75	316,51
TRPE11022590	225-90	328,91
TRPE11225110	225-110	331,35
TRPE11225125	225-125	332,25
TRPE11225140	225-140	332,45
TRPE11225160	225-160	332,45
TRPE11250160	250-160	436,94
TRPE11280160	280-160	373,54
TRPE11315160	315-160	508,23

PE 100 SDR17 - Máxima presión de trabajo permitida 10 bar (agua) / 5 bar (gas)

Ref.	Ø	€/Ud.
TRPE17011063	110-63	46,28
TRPE17011090	110-90	35,56
TRPE17012563	125-63	61,02
TRPE17012575	125-75	61,02
TRPE17012590	125-90	61,02
TRPE17125110	125-110	61,02
TRPE17014063	140-63	100,70
TRPE17014075	140-75	100,70
TRPE17014090	140-90	100,70
TRPE17140110	140-110	104,66
TRPE17016063	160-63	126,86
TRPE17016075	160-75	130,76
TRPE17016090	160-90	130,76
TRPE17160110	160-110	131,88
TRPE17018075	180-75	201,91
TRPE17018090	180-90	201,91
TRPE17180110	180-110	201,91

Ref.	Ø	€/Ud.
TRPE17180125	180-125	201,91
TRPE17180140	180-140	176,29
TRPE17180160	180-160	176,29
TRPE17020063	200-63	225,91
TRPE17020075	200-75	225,91
TRPE17020090	200-90	225,91
TRPE17200110	200-110	144,82
TRPE17200125	200-125	225,91
TRPE17200160	200-160	225,91
TRPE17022563	225-63	296,38
TRPE17022575	225-75	296,38
TRPE17022590	225-90	296,38
TRPE17225110	225-110	298,49
TRPE17225125	225-125	298,49
TRPE17225140	225-140	298,49
TRPE17225160	225-160	298,49

Para otras medidas, diámetros y tipo de accesorios, consultar.



Aplicación

**CDPE - TAPÓN**

Con cuello largo para soldar con accesorios de alta seguridad FRIALEN, o soldadura a tope.

PE 100 SDR11 - Máxima presión de trabajo permitida 16 bar (agua) / 10 bar (gas)

Ref.	Ø	€/Ud.
CDPE11000025	25	4,10
CDPE11000032	32	4,77
CDPE11000040	40	6,37
CDPE11000050	50	8,14
CDPE11000063	63	10,75
CDPE11000075	75	19,93
CDPE11000090	90	11,20
CDPE11000110	110	17,49
CDPE11000125	125	35,42
CDPE11000140	140	44,63
CDPE11000160	160	34,91
CDPE11000180	180	64,22
CDPE11000200	200	63,94
CDPE11000225	225	95,48
CDPE11000250	250	110,02
CDPE11000280	280	155,01
CDPE11000315	315	212,27
CDPE11000355	355	419,17
CDPE11000400	400	529,50
CDPE11000450	450	414,63
CDPE11000500	500	546,51
CDPE11000630	630	1.193,95

PE 100 SDR17 - Máxima presión de trabajo permitida 10 bar (agua) / 5 bar (gas)

Ref.	Ø	€/Ud.
CDPE17000063	63	2,53
CDPE17000075	75	20,10
CDPE17000090	90	10,36
CDPE17000110	110	13,64
CDPE17000125	125	35,34
CDPE17000140	140	44,29
CDPE17000160	160	28,96
CDPE17000180	180	64,22
CDPE17000200	200	58,24
CDPE17000225	225	95,48
CDPE17000250	250	56,69
CDPE17000280	280	155,01
CDPE17000315	315	212,27
CDPE17000355	355	332,81
CDPE17000400	400	408,00
CDPE17000450	450	276,37
CDPE17000500	500	361,08
CDPE17000630	630	733,60



Aplicación



CUPE - CURVA 11°

Con cuello largo para soldar con accesorios de alta seguridad FRIALEN, o soldadura a tope.

PE 100 SDR11 - Máxima presión de trabajo permitida 16 bar (agua) / 10 bar (gas)

Ref.	Ø	€/Ud.
CU11PE110090	90	84,09
CU11PE110110	110	111,99
CU11PE110125	125	124,39
CU11PE110140	140	140,30
CU11PE110160	160	160,23
CU11PE110180	180	267,81
CU11PE110200	200	324,45
CU11PE110225	225	387,32
CU11PE110250	250	464,28
CU11PE110280	280	567,87
CU11PE110315	315	689,15
CU11PE110355	355	1.272,51
CU11PE110400	400	1.413,88
CU11PE110450	450	1.737,21

PE 100 SDR17 - Máxima presión de trabajo permitida 10 bar (agua) / 5 bar (gas)

Ref.	Ø	€/Ud.
CU11PE170090	90	69,04
CU11PE170110	110	88,52
CU11PE170125	125	100,51
CU11PE170140	140	114,65
CU11PE170160	160	123,04
CU11PE170180	180	196,52
CU11PE170200	200	237,70
CU11PE170225	225	251,03
CU11PE170250	250	349,65
CU11PE170280	280	398,83
CU11PE170315	315	514,29
CU11PE170355	355	820,16
CU11PE170400	400	1.241,94
CU11PE170450	450	1.382,33



Aplicación



CUPE - CURVA 22°

Con cuello largo para soldar con accesorios de alta seguridad FRIALEN, o soldadura a tope.

PE 100 SDR11 - Máxima presión de trabajo permitida 16 bar (agua) / 10 bar (gas)

Ref.	Ø	€/Ud.
CU22PE110090	90	84,09
CU22PE110110	110	111,99
CU22PE110125	125	124,39
CU22PE110140	140	140,30
CU22PE110160	160	160,23
CU22PE110180	180	267,81
CU22PE110200	200	324,45
CU22PE110225	225	387,32
CU22PE110250	250	464,28
CU22PE110280	280	567,87
CU22PE110315	315	689,15
CU22PE110355	355	1.272,51
CU22PE110400	400	1.413,88
CU22PE110450	450	1.737,21

PE 100 SDR17 - Máxima presión de trabajo permitida 10 bar (agua) / 5 bar (gas)

Ref.	Ø	€/Ud.
CU22PE170090	90	69,04
CU22PE170110	110	88,52
CU22PE170125	125	100,51
CU22PE170140	140	102,08
CU22PE170160	160	123,04
CU22PE170180	180	196,52
CU22PE170200	200	211,62
CU22PE170225	225	281,96
CU22PE170250	250	349,65
CU22PE170280	280	355,07
CU22PE170315	315	514,29
CU22PE170355	355	820,16
CU22PE170400	400	1.241,94
CU22PE170450	450	1.382,33



Aplicación



CUPE - CURVA 30°

Con cuello largo para soldar con accesorios de alta seguridad FRIALEN, o soldadura a tope.

PE 100 SDR11 - Máxima presión de trabajo permitida 16 bar (agua) / 10 bar (gas)

Ref.	Ø	€/Ud.
CU30PE110090	90	84,09
CU30PE110110	110	111,99
CU30PE110125	125	110,75
CU30PE110140	140	140,30
CU30PE110160	160	142,63
CU30PE110180	180	267,81
CU30PE110200	200	288,86
CU30PE110225	225	344,83
CU30PE110250	250	413,36
CU30PE110280	280	567,87
CU30PE110315	315	613,56
CU30PE110355	355	1.132,93
CU30PE110400	400	1.413,88
CU30PE110450	450	1.737,21

PE 100 SDR17 - Máxima presión de trabajo permitida 10 bar (agua) / 5 bar (gas)

Ref.	Ø	€/Ud.
CU30PE170090	90	69,04
CU30PE170110	110	88,52
CU30PE170125	125	100,51
CU30PE170140	140	114,65
CU30PE170160	160	123,04
CU30PE170180	180	196,52
CU30PE170200	200	211,62
CU30PE170225	225	281,96
CU30PE170250	250	349,65
CU30PE170280	280	355,07
CU30PE170315	315	514,29
CU30PE170355	355	820,16
CU30PE170400	400	1.241,94
CU30PE170450	450	1.382,33



Aplicación



CUPE - CURVA 45°

Con cuello largo para soldar con accesorios de alta seguridad FRIALEN, o soldadura a tope.

PE 100 SDR11 - Máxima presión de trabajo permitida 16 bar (agua) / 10 bar (gas)

Ref.	Ø	€/Ud.
CU45PE110090	90	84,09
CU45PE110110	110	111,99
CU45PE110125	125	124,39
CU45PE110140	140	140,30
CU45PE110160	160	160,23
CU45PE110180	180	267,81
CU45PE110200	200	288,86
CU45PE110225	225	387,32
CU45PE110250	250	464,28
CU45PE110280	280	567,87
CU45PE110315	315	689,15
CU45PE110355	355	1.272,51
CU45PE110400	400	1.413,88
CU45PE110450	450	1.737,21

PE 100 SDR17 - Máxima presión de trabajo permitida 10 bar (agua) / 5 bar (gas)

Ref.	Ø	€/Ud.
CU45PE170090	90	69,04
CU45PE170110	110	88,52
CU45PE170125	125	100,51
CU45PE170140	140	114,65
CU45PE170160	160	123,04
CU45PE170180	180	174,97
CU45PE170200	200	237,70
CU45PE170225	225	281,96
CU45PE170250	250	349,65
CU45PE170280	280	398,83
CU45PE170315	315	514,29
CU45PE170355	355	820,16
CU45PE170400	400	1.241,94
CU45PE170450	450	1.382,33



Aplicación



CUPE - CURVA 60°

Con cuello largo para soldar con accesorios de alta seguridad FRIALEN, o soldadura a tope.

PE 100 SDR11 - Máxima presión de trabajo permitida 16 bar (agua) / 10 bar (gas)

Ref.	Ø	€/Ud.
CU60PE110090	90	74,88
CU60PE110110	110	99,72
CU60PE110125	125	110,75
CU60PE110140	140	124,92
CU60PE110160	160	160,23
CU60PE110180	180	267,81
CU60PE110200	200	324,45
CU60PE110225	225	344,83
CU60PE110250	250	413,36
CU60PE110280	280	505,59
CU60PE110315	315	613,56
CU60PE110355	355	1.132,93
CU60PE110400	400	1.258,78
CU60PE110450	450	1.546,67

PE 100 SDR17 - Máxima presión de trabajo permitida 10 bar (agua) / 5 bar (gas)

Ref.	Ø	€/Ud.
CU60PE170090	90	61,47
CU60PE170110	110	78,81
CU60PE170125	125	89,48
CU60PE170140	140	102,08
CU60PE170160	160	109,54
CU60PE170180	180	174,97
CU60PE170200	200	211,62
CU60PE170225	225	251,03
CU60PE170250	250	311,31
CU60PE170280	280	355,07
CU60PE170315	315	457,88
CU60PE170355	355	730,21
CU60PE170400	400	1.105,71
CU60PE170450	450	1.329,15



Aplicación



CUPE - CURVA 90°

Con cuello largo para soldar con accesorios de alta seguridad FRIALEN, o soldadura a tope.

PE 100 SDR11 - Máxima presión de trabajo permitida 16 bar (agua) / 10 bar (gas)

Ref.	Ø	€/Ud.
CU90PE110090	90	87,17
CU90PE110110	110	116,42
CU90PE110125	125	133,65
CU90PE110140	140	153,58
CU90PE110160	160	178,81
CU90PE110180	180	295,23
CU90PE110200	200	358,49
CU90PE110225	225	425,35
CU90PE110250	250	529,33
CU90PE110280	280	663,04
CU90PE110315	315	822,83
CU90PE110355	355	1.230,91
CU90PE110400	400	1.385,16
CU90PE110450	450	1.957,72

PE 100 SDR17 - Máxima presión de trabajo permitida 10 bar (agua) / 5 bar (gas)

Ref.	Ø	€/Ud.
CU90PE170090	90	71,29
CU90PE170110	110	91,67
CU90PE170125	125	106,26
CU90PE170140	140	122,62
CU90PE170160	160	134,52
CU90PE170180	180	215,10
CU90PE170200	200	258,94
CU90PE170225	225	304,97
CU90PE170250	250	395,68
CU90PE170280	280	459,45
CU90PE170315	315	599,75
CU90PE170355	355	728,21
CU90PE170400	400	1.219,38
CU90PE170450	450	1.597,87



**PORTABRIDAS INYECTADO
CUELLO LARGO SDR 11**

*Máxima presión de trabajo permitida
16 bar (agua) / 10 bar (gas)*

Ref.	Ø	€/Ud
4013025	25	2,19
4013032	32	3,40
4013040	40	3,65
4013050	50	3,65
4013063	63	4,55
4013075	75	6,74
4013090	90	8,62
4013110	110	11,70
4013125	125	14,31
4013140	140	18,83
4013160	160	22,00
4013180	180	25,74
4013200	200	38,93
4013225	225	40,11
4013250	250	73,96
4013280	280	93,57
4013315	315	110,89
4013355	355	189,48
4013400	400	308,73
4013450	450	411,79
4013500	500	350,83
4013560	560	Consultar
4013630	630	Consultar

**PORTABRIDAS INYECTADO
CUELLO LARGO SDR 17**

*Máxima presión de trabajo permitida
10 bar (agua) / 5 bar (gas)*

Ref.	Ø	€/Ud
4013050010	50	10,75
4013063010	63	6,43
4013075010	75	7,55
4013090010	90	7,10
4013110010	110	9,63
4013125010	125	10,38
4013140010	140	15,32
4013160010	160	19,81
4013180010	180	20,74
4013200010	200	28,38
4013225010	225	36,96
4013250010	250	66,69
4013280010	280	80,80
4013315010	315	99,69
4013355010	355	157,09
4013400010	400	297,84
4013450010	450	358,52
4013500010	500	291,13
4013560010	560	506,97
4013630010	630	650,05



PORTABRIDAS MANIPULADO SDR 11

Máxima presión de trabajo permitida 16 bar (agua)

Ref.	Ø	€/Ud
136280000160	280	180,76
136315000160	315	230,92
136355000160	355	366,55
136400000160	400	462,16
136450000160	450	771,91
136500000160	500	723,31
136560000160	560	1.053,76
136630000160	630	1.019,32

PORTABRIDAS MANIPULADO SDR 17

Máxima presión de trabajo permitida 10 bar (agua)

Ref.	Ø	€/Ud
136280000100	280	128,75
136315000100	315	163,79
136355000100	355	267,31
136400000100	400	345,28
136450000100	450	577,68
136500000100	500	556,57
136560000100	560	924,73
136630000100	630	762,57
136710000100	710	1.152,34
136800000100	800	1.473,34
136900000100	900	1.784,86
136100000100	1000	5.206,61



BRIDAS DE ACERO CINCADO
PN10 (DIN 2576) MOP 10 BAR

Ref.	PN	Ø Tubo	DN	Nº Agujeros	€/Ud
311050016055	10/16	50	40	4	12,27
311063016055	10/16	63	50	4	14,29
311075016055	10/16	75	65	4	17,48
311090016055	10/16	90	80	8	22,04
311110016055	10/16	110	100	8	24,31
311125016055	10/16	125	125	8	32,68
311140016055	10/16	140	125	8	27,44
311160016055	10/16	160	150	8	41,26
311180016055*	10/16	180	150	8	51,50
311200010055	10	200	200	8	56,89
311225010055*	10	225	200	8	73,83
311250010055	10	250	250	12	59,36
311280010055*	10	280	250	12	92,44
311315010055	10	315	300	12	76,45
311355010055	10	355	350	16	103,88
311400010055	10	400	400	16	145,28
311450010055*	10	450	450	20	Consultar
311500010155*	10	450-500	500	20	320,87
311500010055	10	500	500	20	207,76
311560010055*	10	560	600	20	402,35
311630010055	10	630	600	20	271,26
311710010055*	10	710	700	24	523,37
311800010055*	10	800	800	24	697,38
311900010055*	10	900	900	28	836,04
311100010055*	10	1000	1000	28	1.066,88

* Galvanizadas

BRIDAS DE ACERO CINCADO
PN16 (DIN 2502) MOP 16 BAR

Ref.	PN	Ø Tubo	DN	Nº Agujeros	€/Ud
311200016055	16	200	200	12	55,93
311225016055*	16	225	200	12	71,12
311250016055	16	250	250	12	74,42
311280016055*	16	280	250	12	100,69
311315016055	16	315	300	12	97,06
311355016055	16	355	350	16	140,32
311400016055	16	400	400	16	176,29
311450016055*	16	450	450	20	Consultar
311500016155*	16	450-500	500	20	434,85
311500016055	16	500	500	20	349,59
311560016055*	16	560	600	20	683,87
311630016055	16	630	600	20	472,92
311710016055*	16	710	700	24	680,81
311800016055*	16	800	800	24	863,77
311900016055*	16	900	900	28	1.026,41
311100016055*	16	1000	1000	28	1.368,80

* Galvanizadas

**BRIDAS CIEGAS DE ACERO CINCADO
PN10 (DIN 2527) MOP 10/16 Y 10 BAR**

Ref.	DN Brida	PN	Nº Agujeros	€/Ud
312015010055	1/2" 15	10/16	4	5,52
312020010055	3/4" 20	10/16	4	7,78
312025010055	1 " 25	10/16	4	9,43
312032010055	1 1/4" 32	10/16	4	12,30
312040010055	1 1/2" 40	10/16	4	14,27
312050010055	2" 50	10/16	4	19,64
312065010055	2 1/2" 65	10/16	4	24,38
312080010055	3 " 80	10/16	4	31,78
312100010055	4 " 100	10/16	8	37,63
312125010055	5" 125	10/16	8	56,51
312150010055	6" 150	10/16	8	69,29
312200010055	8" 200	10	8	109,85
312250010055	10" 250	10	12	159,85
312300010055	12" 300	10	12	205,71
312350010055	14" 350	10	16	268,44
312400010055	16" 400	10	16	329,41
312450010055	18" 450	10	20	419,22
312500010055	20" 500	10	20	499,35
312600010055	24" 600	10	20	729,24

**BRIDAS CIEGAS DE ACERO CINCADO
PN16 (DIN 2527) MOP 16 BAR**

Ref.	DN Brida	PN	Nº Agujeros	€/Ud
312200016055	8" 200	16	12	106,16
312250016055	10" 250	16	12	163,87
312300016055	12" 300	16	12	230,42
312350016055	14" 350	16	16	313,24
312400016055	16" 400	16	16	416,49
312450016055	18" 450	16	20	570,46
312500016055	20" 500	16	20	668,90
312600016055	24" 600	16	20	934,54

ODB



d	Ref.	DN	PN	€
20	ODB020	15	16	8,85
25	ODB025	20	16	9,72
32	ODB032	25	16	12,51
40	ODB040	32	16	15,18
50	ODB050	40	16	17,75
63	ODB063	50	16	22,08
75	ODB075	65	16	24,40
90	ODB090	80	16	29,06
110	ODB110	100	16	35,07
125	ODB125	100	16	35,07
140	ODB140	125	16	52,43
140	ODB140DN125	*125	16	50,37
160	ODB160	150	16	53,41
180	ODB180	150	16	61,24
200	ODB200PN16	200	16	80,21
225	ODB225PN16	200	16	80,21
250	ODB250PN16	250	16	100,41
280	ODB280PN16	250	16	102,29
315	ODB315PN16	300	16	156,19
355	ODB355PN16	350	16	292,39
400	ODB400PN16	400	16	421,93
450	ODB150PN16	450	16	754,43
500	ODB500PN16	500	16	754,43
560	ODB560PN16	600	16	1.023,11
630	ODB630PN16	600	16	1.037,63

Brida loca PP con alma de acero

DIN 2501 DIN 16962/16963.

* Para portabridas PVC-U

Ver descuentos aplicables según "Familia PP"

A partir de Ø 75 no utilizar

con portabridas socket

(sólo testa)

ODB



d	Ref.	DN	PN	€
200	ODB200	200	10	80,21
225	ODB225	200	10	80,21
225	ODB225DN200	*200	10	103,49
250	ODB250	250	10	100,41
280	ODB280	250	10	102,29
280	ODB280DN250	*250	10	107,16
315	ODB315	300	10	156,19
315	ODB315DN300	*300	10	156,94
355	ODB355	350	10	292,39
400	ODB400	400	10	421,93
450	ODB450	450	10	754,43
500	ODB500	500	10	754,43
560	ODB560	600	10	1.023,11
630	ODB630	600	10	1.037,63

Brida loca PP con alma de acero

DIN 2501 DIN 16962/16963.

* Para portabridas PVC-U

Ver descuentos aplicables según "Familia PP"

A partir de Ø 75 no utilizar

con portabridas socket

(sólo testa)

OAB



d	Ref.	DN	€
½"	OAB012	15	10,99
¾"	OAB034	20	13,68
1"	OAB100	25	16,14
1¼"	OAB114	32	18,59
1½"	OAB112	40	23,19
2"	OAB200	50	28,81
2½"	OAB212	65	35,60
3"	OAB300	80	41,73
4"	OAB400	100	54,44
6"	OAB600	150	102,85
8"	OAB800	200	148,79
10"	OAB810	250	191,63
12"	OAB812	300	295,58
14"	OAB814	350	557,70
16"	OAB816	400	680,04

Brida loca PP con alma de acero

ANSI 150 lbs.

Ver descuentos aplicables según "Familia PP"

A partir de Ø 75 no utilizar

con portabridas socket

(sólo testa)

ODBC



d	Ref.	DN	PN	€
20	ODBC020	15	16	67,53
25	ODBC025	20	16	68,59
32	ODBC032	25	16	70,33
40	ODBC040	32	16	75,32
50	ODBC050	40	16	85,30
63	ODBC063	50	16	92,89
75	ODBC075	65	16	108,81
90	ODBC090	80	16	119,75
110/125	ODBC110	100	16	163,58
140	ODBC140	125	16	200,88
160/180	ODBC160	150	16	253,51
200/225	ODBC200	200	10	281,56
250/280	ODBC250	250	10	367,93
315	ODBC315	300	10	537,13
355	ODBC355	350	10	1.050,68
400	ODBC400	400	10	1.200,24

Brida ciega PP con alma de acero DIN 2501

Ver descuentos aplicables según "Familia PP"

OABC



d	Ref.	DN	€
½"	OABC012	15	78,52
¾"	OABC034	20	79,63
1"	OABC100	25	81,59
1¼"	OABC114	32	87,42
1½"	OABC112	40	99,25
2"	OABC200	50	108,02
2½"	OABC212	65	123,41
3"	OABC300	80	139,15
4"	OABC400	100	190,13
6"	OABC600	150	294,77
8"	OABC800	200	327,32
10"	OABC810	250	427,45
12"	OABC812	300	624,68

Brida ciega PP con alma de acero ANSI 150 lbs.

Ver descuentos aplicables según "Familia PP"

Accesorios de PE



Accesorios de Polietileno inyectados cortos

INFRAESTRUCTURA





Aplicación



Aplicación

**TBE - TÉS IGUALES A 90° CORTAS**

Con cuello corto para soldadura a tope

PE 100 SDR11 - Máxima presión de trabajo permitida 16 bar (agua) / 10 bar (gas)

Ref.	Ø	€/Ud.
TBE11020	20	1,63
TBE11025	25	1,63
TBE11032	32	2,05
TBE11040	40	3,26
TBE11050	50	5,00
TBE11063	63	8,48
TBE11075	75	13,64
TBE11090	90	20,38
TBE11110	110	29,92
TBE11125	125	41,20
TBE11140	140	52,20
TBE11160	160	87,79
TBE11180	180	112,55
TBE11200	200	161,27
TBE11225	225	191,81
TBE11250	250	244,01
TBE11280	280	329,89
TBE11315	315	468,63
TBE11355	355	858,89
TBE11400	400	1.282,47
TBE11450	450	1.568,84
TBE11500	500	2.005,09

PE 100 SDR17 - Máxima presión de trabajo permitida 10 bar (agua) / 5 bar (gas)

Ref.	Ø	€/Ud.
TBE17050	50	3,87
TBE17063	63	6,99
TBE17075	75	10,75
TBE17090	90	15,32
TBE17110	110	25,46
TBE17125	125	35,25
TBE17140	140	41,62
TBE17160	160	86,44
TBE17180	180	96,13
TBE17200	200	131,27
TBE17225	225	154,11
TBE17250	250	204,52
TBE17280	280	254,14
TBE17315	315	337,08
TBE17355	355	725,01
TBE17400	400	990,94
TBE17450	450	1.275,99
TBE17500	500	1.642,07

TRBE - TÉS REDUCIDAS A 90° CORTAS

Con cuello corto para soldadura a tope

PE 100 SDR11 - Máxima presión de trabajo permitida 16 bar (agua) / 10 bar (gas)

Ref.	Ø	€/Ud.
TRBE11090050	90-50	30,42
TRBE11110032	110-32	43,70
TRBE111100500	110-50	44,47
TRBE11125063	125-63	62,39
TRBE11140063	140-63	78,31
TRBE11140075	140-75	78,31
TRBE11140090	140-90	79,57
TRBE11140110	140-110	79,57
TRBE11160110	160-110	140,05
TRBE11160125	160-125	140,05
TRBE11180063	180-63	163,94
TRBE11180075	180-75	163,94
TRBE11180125	180-125	169,21
TRBE11225110	225-110	297,28
TRBE11225125	225-125	297,28
TRBE11225160	225-160	308,98
TRBE11250160	250-160	2,92

PE 100 SDR17 - Máxima presión de trabajo permitida 10 bar (agua) / 5 bar (gas)

Ref.	Ø	€/Ud.
TRBE17110090	110-90	45,50
TRBE17140063	140-63	60,79
TRBE17140075	140-75	61,07
TRBE17140090	140-90	62,06
TRBE17140110	140-110	63,35
TRBE17160110	160-110	123,94
TRBE17160125	160-125	123,94
TRBE17180063	180-63	140,22
TRBE17180075	180-75	140,22
TRBE17180125	180-125	144,49
TRBE17225110	225-110	247,97
TRBE17225125	225-125	247,97
TRBE17225160	225-160	247,97



Aplicación



RBE - REDUCCIONES CONCÉNTRICAS CORTAS

Con cuello corto para soldadura a tope

PE 100 SDR11 - Máxima presión de trabajo permitida 16 bar (agua) / 10 bar (gas)

Ref.	Ø	€/Ud.
RBE11025020	25-20	3,17
RBE11032020	32-20	3,70
RBE11032025	32-25	3,70
RBE11040020	40-20	4,24
RBE11040025	40-25	4,24
RBE11040032	40-32	4,24
RBE11050025	50-25	4,43
RBE11050032	50-32	4,43
RBE11050040	50-40	4,43
RBE11063032	63-32	5,36
RBE11063040	63-40	5,36
RBE11063050	63-50	5,36
RBE11075032	75-32	6,88
RBE11075040	75-40	6,88
RBE11075063	75-63	6,88
RBE11090050	90-50	7,63
RBE11090063	90-63	7,63
RBE11090075	90-75	7,63
RBE11110050	110-50	9,74
RBE11110063	110-63	9,74
RBE11110075	110-75	9,74
RBE11110090	110-90	9,74
RBE11125063	125-63	12,52
RBE11125075	125-75	12,52
RBE11125090	125-90	11,31
RBE11125110	125-110	12,52
RBE11140075	140-75	15,16
RBE11140090	140-90	15,16
RBE11140110	140-110	13,58
RBE11140125	140-125	13,58
RBE11160090	160-90	17,79
RBE11160110	160-110	17,79
RBE11160125	160-125	17,79
RBE11160140	160-140	17,79
RBE11180090	180-90	27,90
RBE11180110	180-110	26,24
RBE11180125	180-125	24,90
RBE11180140	180-140	22,96
RBE11180160	180-160	21,95
RBE11200140	200-140	62,81
RBE11200160	200-160	40,98
RBE11200180	200-180	34,35
RBE11225140	225-140	75,05

Ref.	Ø	€/Ud.
RBE11225160	225-160	52,82
RBE11225180	225-180	52,82
RBE11225200	225-200	58,15
RBE11250160	250-160	85,83
RBE11250180	250-180	79,18
RBE11250200	250-200	73,20
RBE11250225	250-225	79,18
RBE11280200	280-200	95,79
RBE11280225	280-225	89,28
RBE11280250	280-250	86,00
RBE11315200	315-200	122,23
RBE11315225	315-225	108,11
RBE11315250	315-250	156,89
RBE11315280	315-280	92,28
RBE11355200	355-200	473,48
RBE11355225	355-225	206,29
RBE11355250	355-250	144,85
RBE11355280	355-280	129,75
RBE11355315	355-315	123,72
RBE11400225	400-225	226,30
RBE11400250	400-250	202,19
RBE11400280	400-280	187,06
RBE11400315	400-315	208,23
RBE11400355	400-355	144,85
RBE11450280	450-280	862,29
RBE11450315	450-315	250,47
RBE11450355	450-355	235,37
RBE11450400	450-400	211,23
RBE11500280	500-280	1.397,22
RBE11500315	500-315	362,14
RBE11500355	500-355	1.006,89
RBE11500400	500-400	301,77
RBE11500450	500-450	271,57
RBE11560355	560-355	1.615,28
RBE11560400	560-400	479,83
RBE11560450	560-450	801,89
RBE11560500	560-500	374,18
RBE11630355	630-355	2.248,13
RBE11630400	630-400	672,95
RBE11630450	630-450	1.647,66
RBE11630500	630-500	537,14
RBE11630560	630-560	446,62



Aplicación



RBE - REDUCCIONES CONCÉNTRICAS CORTAS

Con cuello corto para soldadura a tope

PE 100 SDR17 - Máxima presión de trabajo permitida 10 bar (agua) / 5 bar (gas)

Ref.	Ø	€/Ud.
RBE17050032	50-32	4,24
RBE17050040	50-40	4,24
RBE17063032	63-32	5,08
RBE17063040	63-40	5,08
RBE17063050	63-50	5,08
RBE17075032	75-32	6,54
RBE17075040	75-40	6,54
RBE17075050	75-50	6,54
RBE17075063	75-63	6,54
RBE17090050	90-50	7,33
RBE17090063	90-63	7,33
RBE17090075	90-75	7,33
RBE17110050	110-50	9,32
RBE17110063	110-63	9,32
RBE17110075	110-75	9,32
RBE17110090	110-90	9,32
RBE17125063	125-63	11,96
RBE17125075	125-75	11,96
RBE17125090	125-90	11,96
RBE17125110	125-110	11,96
RBE17140075	140-75	14,48
RBE17140090	140-90	14,48
RBE17140110	140-110	14,48
RBE17140125	140-125	14,48
RBE17160090	160-90	13,58
RBE17160110	160-110	14,51
RBE17160125	160-125	16,90
RBE17160140	160-140	13,14
RBE17180090	180-90	19,93
RBE17180110	180-110	20,35
RBE17180125	180-125	23,07
RBE17180140	180-140	17,65
RBE17180160	180-160	18,52
RBE17200140	200-140	29,55
RBE17200160	200-160	31,69
RBE17200180	200-180	29,02
RBE17225140	225-140	41,20
RBE17225160	225-160	53,86
RBE17225180	225-180	58,41
RBE17225200	225-200	41,20
RBE17250160	250-160	67,33
RBE17250180	250-180	67,58
RBE17250200	250-200	62,03
RBE17250225	250-225	57,59
RBE17280200	280-200	84,48
RBE17280225	280-225	84,48

Ref.	Ø	€/Ud.
RBE17280250	280-250	75,53
RBE17315200	315-200	122,15
RBE17315225	315-225	104,66
RBE17315250	315-250	93,83
RBE17315280	315-280	87,85
RBE17355200	355-200	457,48
RBE17355225	355-225	120,74
RBE17355250	355-250	104,13
RBE17355280	355-280	99,58
RBE17355315	355-315	86,28
RBE17400225	400-225	150,89
RBE17400250	400-250	150,89
RBE17400280	400-280	144,85
RBE17400315	400-315	179,60
RBE17400355	400-355	108,59
RBE17450280	450-280	862,29
RBE17450315	450-315	765,26
RBE17450355	450-355	520,77
RBE17450400	450-400	147,83
RBE17500280	500-280	1.397,22
RBE17500315	500-315	251,39
RBE17500355	500-355	919,71
RBE17500400	500-400	202,19
RBE17500450	500-450	196,16
RBE17560355	560-355	1.819,23
RBE17560400	560-400	908,23
RBE17560450	560-450	742,64
RBE17560500	560-500	635,99
RBE17630355	630-355	1.965,57
RBE17630400	630-400	1.213,32
RBE17630450	630-450	1.007,59
RBE17630500	630-500	879,60
RBE17630560	630-560	675,56
RBE17710500	710-500	1.312,89
RBE17710560	710-560	1.181,88
RBE17710630	70-630	961,28
RBE17800560	800-560	1.638,51
RBE17800630	800-630	1.379,42
RBE17800710	800-710	1.250,93
RBE17900630	900-630	2.285,08
RBE17900710	900-710	1.960,24
RBE17900800	900-800	1.364,09
RBE171000710	1000-710	4.595,58
RBE171000800	1000-800	2.582,12
RBE171000900	1000-900	1.052,44



Aplicación

**REBE - REDUCCIONES EXCÉNTRICAS CORTAS**

Con cuello corto para soldadura a tope

PE 100 SDR11 - Máxima presión de trabajo permitida 16 bar (agua) / 10 bar (gas)

Ref.	Ø	€/Ud.
REBE11160090	160-90	199,47
REBE11160110	160-110	178,98
REBE11160125	160-125	159,98
REBE11160140	160-140	140,95
REBE11180110	180-110	236,49
REBE11180125	180-125	210,11
REBE11180140	180-140	194,78
REBE11180160	180-160	179,23
REBE11200125	200-125	397,42
REBE11200140	200-140	231,80
REBE11200160	200-160	205,87
REBE11200180	200-180	194,78
REBE11225140	225-140	320,41
REBE11225160	225-160	296,47
REBE11225180	225-180	257,96
REBE11225200	225-200	234,80
REBE11250160	250-160	487,52
REBE11250180	250-180	366,10
REBE11250200	250-200	331,55
REBE11250225	250-225	285,63
REBE11280180	280-180	546,17
REBE11280200	280-200	381,14
REBE11280225	280-225	347,07
REBE11280250	280-250	307,83
REBE11315200	315-200	629,81
REBE11315225	315-225	417,91
REBE11315250	315-250	362,40
REBE11315280	315-280	328,07

PE 100 SDR17 - Máxima presión de trabajo permitida 10 bar (agua) / 5 bar (gas)

Ref.	Ø	€/Ud.
REBE17160090	160-90	189,90
REBE17160110	160-110	164,92
REBE17160125	160-125	150,10
REBE17160140	160-140	133,54
REBE17180110	180-110	363,18
REBE17180125	180-125	200,00
REBE17180140	180-140	182,21
REBE17180160	180-160	167,39
REBE17200125	200-125	242,92
REBE17200140	200-140	219,48
REBE17200160	200-160	193,55
REBE17200180	200-180	182,43
REBE17225140	225-140	304,86
REBE17225160	225-160	285,35
REBE17225180	225-180	249,09
REBE17225200	225-200	223,66
REBE17250160	250-160	487,52
REBE17250180	250-180	348,05
REBE17250200	250-200	318,95
REBE17250225	250-225	265,62
REBE17280180	280-180	406,57
REBE17280200	280-200	374,01
REBE17280225	280-225	336,71
REBE17280250	280-250	288,58
REBE17315200	315-200	450,24
REBE17315225	315-225	398,69
REBE17315250	315-250	348,78
REBE17315280	315-280	316,73



Aplicación

**GBE - CURVAS CORTAS DE 90°**

Con cuello corto para soldadura a tope

PE 100 SDR11 - Máxima presión de trabajo permitida 16 bar (agua) / 10 bar (gas)

Ref.	Ø	€/Ud.
GBE11020*	20	2,02
GBE11025*	25	2,10
GBE11032*	32	2,19
GBE11040*	40	2,83
GBE11050*	50	3,56
GBE11063*	63	5,08
GBE11075*	75	10,50
GBE11090*	90	12,94
GBE11110*	110	19,39
GBE11125	125	27,31
GBE11140	140	36,77
GBE11160	160	44,49
GBE11180	180	52,68
GBE11200	200	92,06
GBE11225	225	113,78
GBE11250	250	180,22
GBE11280	280	249,54
GBE11315	315	338,51
GBE11355	355	742,05
GBE11400	400	1.019,01
GBE11450	450	1.337,15
GBE11500	500	1.597,14

PE 100 SDR17 - Máxima presión de trabajo permitida 10 bar (agua) / 5 bar (gas)

Ref.	Ø	€/Ud.
GBE17050*	50	3,40
GBE17063*	63	4,69
GBE17075*	75	6,88
GBE17090*	90	11,25
GBE17110*	110	18,89
GBE17125	125	24,02
GBE17140	140	34,86
GBE17160	160	38,45
GBE17180	180	49,31
GBE17200	200	60,93
GBE17225	225	72,58
GBE17250	250	122,54
GBE17280	280	168,06
GBE17315	315	220,01
GBE17355	355	546,76
GBE17400	400	761,33
GBE17450	450	995,27
GBE17500	500	1.255,92



Aplicación



BBEC - UNIONES 3 PIEZAS CORTAS

Con cuello corto para soldadura a tope

PE 100 SDR11 - Máxima presión de trabajo permitida 10 bar (agua)

Ref.	Ø	€/Ud.
BBEC11020E	20	16,70
BBEC11025E	25	16,05
BBEC11032E	32	20,35
BBEC11040E	40	23,55
BBEC11050E	50	40,67
BBEC11063E	63	63,37
BBEC11075E	75	112,72
BBEC11110E	110	190,63



Aplicación



BBEL - UNIONES 3 PIEZAS LARGAS

Con cuello largo para soldadura a tope y electrofusión

PE 100 SDR11 - Máxima presión de trabajo permitida 10 bar (agua)

Ref.	Ø	€/Ud.
BBEL11020E	20	19,98
BBEL11025E	25	22,40
BBEL11032E	32	25,96
BBEL11040E	40	33,93
BBEL11050E	50	45,92
BBEL11063E	63	71,71
BBEL11075E	75	66,24
BBEL11110E	110	99,97



Aplicación



DBME - TERMINAL ROSCA HEMBRA LARGO

Con cuello largo para soldadura a tope

PE 100 SDR11 - Máxima presión de trabajo permitida 10 bar (agua)

Ref.	Ø x Rh	€/Ud.
DBME11020012	20 x 1/2"	5,36
DBME11025034	25 x 3/4"	6,93
DBME11032100	32 x 1"	8,17
DBME11040114	40 x 1 1/4"	9,57
DBME11050112	50 x 1 1/2"	11,98
DBME11063200	63 x 2"	14,17



Aplicación



KBFE - TERMINAL ROSCA MACHO CORTO

Con cuello corto para soldadura a tope

PE 100 SDR11 - Máxima presión de trabajo permitida 8 bar (agua)

Ref.	Ø x Rm	€/Ud.
KBFE11020012	20 x 1/2"	5,50
KBFE11025034	25 x 3/4"	6,60
KBFE11032100	32 x 1"	8,34
KBFE11040114	40 x 1 1/4"	10,05
KBFE11050112	50 x 1 1/2"	16,48
KBFE11063200	63 x 2"	20,83



QBE - PORTABRIDAS CORTOS PE 100 SDR 11
Máxima presión de trabajo permitida 16 bar (agua) / 10 bar (gas)

Ref.	Ø	€/Ud
QBE11032	32	2,19
QBE11040	40	2,58
QBE11050	50	3,20
QBE11063	63	3,96
QBE11075	75	6,37
QBE11090	90	6,71
QBE11110	110	13,33
QBE11125	125	10,44
QBE11140	140	12,18
QBE11160	160	15,35
QBE11180	180	23,83
QBE11200	200	26,21
QBE11225	225	48,92
QBE11250	250	44,37
QBE11280	280	48,47
QBE11315	315	57,12
QBE11355	355	174,83
QBE11400	400	216,48
QBE11450	450	403,96
QBE11500	500	337,98
QBE11560	560	522,85
QBE11630	630	886,03
QBE11710	710	678,96
QBE11800	800	935,46

QBE - PORTABRIDAS CORTOS PE 100 SDR 17
Máxima presión de trabajo permitida 10 bar (agua) / 5 bar (gas)

Ref.	Ø	€/Ud
QBE17050	50	2,89
QBE17063	63	4,46
QBE17075	75	5,56
QBE17090	90	8,48
QBE17110	110	10,72
QBE17125	125	10,16
QBE17140	140	16,31
QBE17160	160	15,91
QBE17180	180	26,83
QBE17200	200	25,20
QBE17225	225	37,75
QBE17250	250	59,95
QBE17280	280	51,08
QBE17315	315	73,70
QBE17355	355	116,17
QBE17400	400	150,77
QBE17450	450	281,23
QBE17500	500	248,25
QBE17560	560	401,38
QBE17630	630	316,90
QBE17710	710	543,20
QBE17800	800	891,25
QBE17900	900	829,84
QBE171000	1000	1.308,43



**BRIDAS DE ACERO CINCADO
PN10 (DIN 2576) MOP 10 BAR**

Ref.	PN	Ø Tubo	DN	Nº Agujeros	€/Ud
311050016055	10/16	50	40	4	12,27
311063016055	10/16	63	50	4	14,29
311075016055	10/16	75	65	4	17,48
311090016055	10/16	90	80	8	22,04
311110016055	10/16	110	100	8	24,31
311125016055	10/16	125	125	8	32,68
311140016055	10/16	140	125	8	27,44
311160016055	10/16	160	150	8	41,26
311180016055*	10/16	180	150	8	51,50
311200010055	10	200	200	8	56,89
311225010055*	10	225	200	8	73,83
311250010055	10	250	250	12	59,36
311280010055*	10	280	250	12	92,44
311315010055	10	315	300	12	76,45
311355010055	10	355	350	16	103,88
311400010055	10	400	400	16	145,28
311450010055*	10	450	450	20	Consultar
311500010155*	10	450-500	500	20	320,87
311500010055	10	500	500	20	207,76
311560010055*	10	560	600	20	402,35
311630010055	10	630	600	20	271,26
311710010055*	10	710	700	24	523,37
311800010055*	10	800	800	24	697,38
311900010055*	10	900	900	28	836,04
311100010055*	10	1000	1000	28	1.066,88

* Galvanizadas

**BRIDAS DE ACERO CINCADO
PN16 (DIN 2502) MOP 16 BAR**

Ref.	PN	Ø Tubo	DN	Nº Agujeros	€/Ud
311200016055	16	200	200	12	55,93
311225016055*	16	225	200	12	71,12
311250016055	16	250	250	12	74,42
311280016055*	16	280	250	12	100,69
311315016055	16	315	300	12	97,06
311355016055	16	355	350	16	140,32
311400016055	16	400	400	16	176,29
311450016055*	16	450	450	20	Consultar
311500016155*	16	450-500	500	20	434,85
311500016055	16	500	500	20	349,59
311560016055*	16	560	600	20	683,87
311630016055	16	630	600	20	472,92
311710016055*	16	710	700	24	680,81
311800016055*	16	800	800	24	863,77
311900016055*	16	900	900	28	1.026,41
311100016055*	16	1000	1000	28	1.368,80

* Galvanizadas

**BRIDAS CIEGAS DE ACERO CINCADO
PN10 (DIN 2527) MOP 10/16 Y 10 BAR**

Ref.	DN Brida	PN	Nº Agujeros	€/Ud
312015010055	1/2" 15	10/16	4	5,52
312020010055	3/4" 20	10/16	4	7,78
312025010055	1 " 25	10/16	4	9,43
312032010055	1 1/4" 32	10/16	4	12,30
312040010055	1 1/2" 40	10/16	4	14,27
312050010055	2" 50	10/16	4	19,64
312065010055	2 1/2" 65	10/16	4	24,38
312080010055	3 " 80	10/16	4	31,78
312100010055	4 " 100	10/16	8	37,63
312125010055	5" 125	10/16	8	56,51
312150010055	6" 150	10/16	8	69,29
312200010055	8" 200	10	8	109,85
312250010055	10" 250	10	12	159,85
312300010055	12" 300	10	12	205,71
312350010055	14" 350	10	16	268,44
312400010055	16" 400	10	16	329,41
312450010055	18" 450	10	20	419,22
312500010055	20" 500	10	20	499,35
312600010055	24" 600	10	20	729,24

**BRIDAS CIEGAS DE ACERO CINCADO
PN16 (DIN 2527) MOP 16 BAR**

Ref.	DN Brida	PN	Nº Agujeros	€/Ud
312200016055	8" 200	16	12	106,16
312250016055	10" 250	16	12	163,87
312300016055	12" 300	16	12	230,42
312350016055	14" 350	16	16	313,24
312400016055	16" 400	16	16	416,49
312450016055	18" 450	16	20	570,46
312500016055	20" 500	16	20	668,90
312600016055	24" 600	16	20	934,54



ODB

d	Ref.	DN	PN	€
20	ODB020	15	16	8,85
25	ODB025	20	16	9,72
32	ODB032	25	16	12,51
40	ODB040	32	16	15,18
50	ODB050	40	16	17,75
63	ODB063	50	16	22,08
75	ODB075	65	16	24,40
90	ODB090	80	16	29,06
110	ODB110	100	16	35,07
125	ODB125	100	16	35,07
140	ODB140	125	16	52,43
140	ODB140DN125	*125	16	50,37
160	ODB160	150	16	53,41
180	ODB180	150	16	61,24
200	ODB200PN16	200	16	91,11
225	ODB225PN16	200	16	91,11
250	ODB250PN16	250	16	114,05
280	ODB280PN16	250	16	116,19
315	ODB315PN16	300	16	177,41
355	ODB355PN16	350	16	332,13
400	ODB400PN16	400	16	479,28
450	ODB150PN16	450	16	856,97
500	ODB500PN16	500	16	856,97
560	ODB560PN16	600	16	1.162,16
630	ODB630PN16	600	16	1.178,68

Brida loca PP con alma de acero
DIN 2501 DIN 16962/16963.

A partir de Ø 75 no utilizar
con portabridas socket
(sólo testa)

* Para portabridas PVC-U

Ver descuentos aplicables según "Familia PP"



ODB

d	Ref.	DN	PN	€
200	ODB200	200	10	80,21
225	ODB225	200	10	80,21
225	ODB225DN200	*200	10	103,49
250	ODB250	250	10	100,41
280	ODB280	250	10	102,29
280	ODB280DN250	*250	10	107,16
315	ODB315	300	10	156,19
315	ODB315DN300	*300	10	156,94
355	ODB355	350	10	292,39
400	ODB400	400	10	421,93
450	ODB450	450	10	754,43
500	ODB500	500	10	754,43
560	ODB560	600	10	1.023,11
630	ODB630	600	10	1.037,63

Brida loca PP con alma de acero
DIN 2501 DIN 16962/16963.

A partir de Ø 75 no utilizar
con portabridas socket
(sólo testa)

* Para portabridas PVC-U

Ver descuentos aplicables según "Familia PP"



OAB

d	Ref.	DN	€
½"	OAB012	15	10,99
¾"	OAB034	20	13,68
1"	OAB100	25	16,14
1¼"	OAB114	32	18,59
1½"	OAB112	40	23,19
2"	OAB200	50	28,81
2½"	OAB212	65	35,60
3"	OAB300	80	41,73
4"	OAB400	100	54,44
6"	OAB600	150	102,85
8"	OAB800	200	148,79
10"	OAB810	250	191,63
12"	OAB812	300	295,58
14"	OAB814	350	557,70
16"	OAB816	400	680,04

Brida loca PP con alma de acero
ANSI 150 lbs.

A partir de Ø 75 no utilizar
con portabridas socket
(sólo testa)

Ver descuentos aplicables según "Familia PP"



ODBC

d	Ref.	DN	PN	€
20	ODBC020	15	16	67,53
25	ODBC025	20	16	68,59
32	ODBC032	25	16	70,33
40	ODBC040	32	16	75,32
50	ODBC050	40	16	85,30
63	ODBC063	50	16	92,89
75	ODBC075	65	16	108,81
90	ODBC090	80	16	119,75
110/125	ODBC110	100	16	163,58
140	ODBC140	125	16	200,88
160/180	ODBC160	150	16	253,51
200/225	ODBC200	200	10	281,56
250/280	ODBC250	250	10	367,93
315	ODBC315	300	10	537,13
355	ODBC355	350	10	1.050,68
400	ODBC400	400	10	1.200,24

Brida ciega PP con alma de acero DIN 2501

Ver descuentos aplicables según "Familia PP"



OABC

d	Ref.	DN	€
½"	OABC012	15	78,52
¾"	OABC034	20	79,63
1"	OABC100	25	81,59
1¼"	OABC114	32	87,42
1½"	OABC112	40	99,25
2"	OABC200	50	108,02
2½"	OABC212	65	123,41
3"	OABC300	80	139,15
4"	OABC400	100	190,13
6"	OABC600	150	294,77
8"	OABC800	200	327,32
10"	OABC810	250	427,45
12"	OABC812	300	624,68

Brida ciega PP con alma de acero ANSI 150 lbs.

Ver descuentos aplicables según "Familia PP"

Uniones y adaptadores brida
Carretes de desmontaje
Abrazaderas de reparación

Accesorios metálicos

INFRAESTRUCTURA





Accesorios metálicos

Uniones y adaptadores bridas

Selector de productos según el material de las tuberías para uniones, uniones reducidas y adaptadores de brida

NOTA: Esta tabla sirve de orientación sobre qué productos Viking Johnson son compatibles con qué materiales de tubería. Consulte la documentación del producto para obtener más detalles sobre su idoneidad final.

Grupos de productos

Grupos de productos		Rango de diámetros nominales (mm)	Fundición dúctil	Fundición	Acero	Acero inoxidable	PVC	HEP30	Polipropileno	PEMD/PE80	PEAD/PE100	PPRV	ABS	Cerámica	Hormigón	Fibras de carbono	Cobre	Plomo
Gran tolerancia																		
MaxiFit (A, C)	Unión	40 - 700	●	●	●	●	●	●	8	8	8	6	●	1	●	6	1	1
	Adaptador de Brid	40 - 700	●	●	●	●	●	●	8	8	8	6	●	1	●	6	1	1
	Unión Reducida	40 - 700	●	●	●	●	●	●	8	8	8	6	●	1	●	6	1	1
MegaFit (A, C)	Unión	50 - 300	●	●	●	●	●	●				6	●	1	●	6		
	Adaptador de Brida	50 - 300	●	●	●	●	●	●				6	●	1	●	6		
	Unión Reducida	50 - 300	●	●	●	●	●	●				6	●	1	●	6		
UltraGrip (A, B)	Unión	40 - 800	●	●	●		●	●	3	3	3	2						2
	Adaptador de Brida	40 - 800	●	●	●		●	●	5	5	3	3	2					2
	Uniones Reducidas	40 - 600	●	●	●		●	●	5	5	3	3	2					2
	Tapones	50 - 300	●	●	●		●	●	5	5	3	3	2					2
	Pecatadaptor	80 - 200	●	●	●		●	●	5	5								
Específicos																		
FlexLock (A, B)	Unión	50 - 300	●		●													
	Adaptador de Brid	50 - 300	●		●													
QuickFit (A, C)	Unión	40 - 300	●		●		●	●					●		●			
	Adaptador de Brida	40 - 300	●		●		●	●					●		●			
Gran Diámetro, Desmontadas (A, C)	Unión	350 y mayores	●	●	●	●	●	●				6	●		●	6		
	Adaptador de Brida	350 y mayores	●	●	●	●	●	●				6	●		●	6		
	Unión Reducida	350 y mayores	●	●	●	●	●	●				6	●		●	6		
Soluciones para PE																		
AquaFast (A, B)	Unión	63 - 315					●	●	●	●	●							
	Unión de Gran Diámetro	355 - 450								●	●							
	Adaptador de Brida	63 - 315					●	●	●	●	●							
	Adaptador de Brida de Gran Diámetro	355 - 450								●	●							
AquaGrip (A, B)	Unión	63 - 180							●	●	●							
	Adaptador de Brida	63 - 180							●	●	●							
	Adaptador de Brida	225 - 800								●	●							
	Adaptador de Brida	900 y mayores									●	●						
Reparaciones de tuberías																		
EasiRange (A)	EasiClamp / Toma	50 - 600	●	●	●		4	4	4	4	4							
	Universal EasiTee	80 - 300	●	●	●													
	Mattseal Easitee/ Toma	350 - 600	●	●	●													
	Ringseal Easite	350 - 1200	●	●	●		●											
	EasiCollar	300 - 1200	●	●											●	●		
HandiRange (A)	HandiBand	15 - 50			●		●	●				●					●	
	HandiClamp / conexión en T	50 - 600	●	●	●	●	●	●	7	7	7	7	●		●	●	●	●

Nota: Un producto Viking Johnson es apto hasta la presión máxima de trabajo indicada con un material de tubería concreto. (1) Contacte con el departamento de marketing de Viking Johnson para obtener más información.

- (A) El material de tubería es apto dentro de la gama de tolerancias de diámetros internos del producto Viking Johnson.
- (B) Productos autoblocantes - Resisten el esfuerzo de tracción gracias a la presión interna de la tubería.
- (C) Productos flexibles - No resisten el esfuerzo de tracción y se deberá proporcionar un método de contención externo apropiado.
- (D) Productos autoblocantes- Resisten el esfuerzo de tracción de acuerdo con la capacidad de presión sin restricciones del casquillo de PE.
- (2) Solo en versión Flex.
- (3) Solo en versión autoblocante con casquillo rigidizador
- (4) Disponible hasta DN200 (rendimiento limitado).
- (5) Puede ser necesario un casquillo rigidizador - consultar la documentación técnica.
- (6) Puede ser necesario un par de apriete menor - ponerse en contacto con Viking Johnson.
- (7) Rendimiento limitado.
- (8) Tramos cortos de hasta 1 m de PE cuando se utiliza con casquillo rigidizador.



Aplicación



Válido para



AQUAFast - UNIONES

Ref.	Ø	Presión Máx. Trabajo (bar)	€/Ud.
70700000063	63	16	166,14
70700000075	75	16	182,68
70700000090	90	16	198,28
70700000110	110	16	215,90
70700000125	125	16	260,92
70700000140	140	16	293,19
70700000160	160	16	339,18
70700000180	180	16	490,49
70700000200	200	16	643,12
70700000225	225	16	797,04
70700000250	250	16	978,21
70700000280	280	16	1179,89
70700000315	315	16	1374,79

Material: Cuerpo de fundición revestido con Rilsan Nylon 11.

Anillo: Fundición Dúctil

Tornillos y Tuercas: Sheraplex.

EPDM para Aplicaciones en Agua



Aplicación



Válido para



AQUAFast - ADAPTADORES DE BRIDA

Ref.	Ø	Presión Máx. Trabajo (bar)	Brida		€/Ud.
			DN	Taladro PN	
70800000063	63	16	50 / 65	10 / 16	116,99
70800000075	75	16	65 / 80	10 / 16	125,59
70800000090	90	16	65 / 80	10 / 16	144,95
70800000110	110	16	100	10 / 16	162,01
70800000125	125	16	100 / 125	10 / 16	195,99
70800000140	140	16	125	10 / 16	228,90
70800000160	160	16	150	10 / 16	259,16
70800000180	180	16	150	10 / 16	342,61
70800000200	200	16	200	10 / 16	438,16
70800000225	225	16	200	10 / 16	531,36
70800000250	250	16	250	10 / 16	640,51
70800000280	280	16	250	10 / 16	773,20
70800000315	315	16	300	10 / 16	909,00

Material: Cuerpo de fundición revestido con Rilsan Nylon 11.

Anillo: Fundición Dúctil

Tornillos y Tuercas: Sheraplex.

EPDM para Aplicaciones en Agua



Aplicación



Válido para



AQUAFast - UNIONES PARA GRANDES DIÁMETROS

Ref.	Ø	Presión Máx. Trabajo (bar)	€/Ud.
70700000355	355	16	4279,94
70700000400	400	16	4698,44
70700000450	450	16	6303,35

Material: Cuerpo de fundición revestido con Rilsan Nylon 11

Anillo antitracción: Fundición Dúctil

Tornillos y tuercas: Acero Inoxidable

Junta: EPDM para Aplicaciones en Agua. Ideal para tubos con ovalación

AQUAFast - ADAPTADORES DE BRIDA PARA GRANDES DIÁMETROS

Ref.	Ø	Presión Máx. Trabajo (bar)	Brida		€/Ud.
			DN	Taladro PN	
708000300355	355	16	300	10 / 16	2644,74
708000350355	355	16	350	10 / 16	2697,66
708000350400	400	16	350	10 / 16	3049,93
708000400400	400	16	400	10 / 16	3110,98
708000400450	450	16	400	10 / 16	4272,71
708000450450	450	16	450	10 / 16	4358,15
708000500450	450	16	500	10 / 16	4445,30



Aplicación



Válido para



AQUAGRIP - ADAPTADORES DE BRIDA ANTITRACCIÓN-AUTOBLOCANTE DE GRAN DIÁMETRO

SDR11

Ref.	Ø Tubo	Brida		€/Ud.*
		DN	Taladro PN	
161355300110	355	300	10	
161355300100	355	300	16	
161355350100	355	350	16	
161400300100	400	300	16	
161400350100	400	350	16	
161400400110	400	400	10	
161400400100	400	400	16	
161450350100	450	350	16	
161450400110	450	400	10	
161450400100	450	400	16	
161450450110	450	450	10	
161450450100	450	450	16	
161450500110	450	500	10	

Material: Cuerpo de fundición revestido con Rilsan Nylon 11

Tornillos y tuercas: hasta d800 Fluoreno, d900 en adelante galvanizado

Junta: EPDM para Aplicaciones en Agua. Ideal para tubos con ovalación



Aplicación



Válido para



MAXIFIT - UNIONES

Ref.	DN	Tolerancia (mm)	Presión Máx. de Trabajo (bar)		€/Ud.*
			Agua	Gas	
701000000005	40	047.9 - 059.5	16	6	88,38
701000000010	50	057.0 - 074.0	16	6	71,43
701000000015	65	063.0 - 085.0	16	6	77,39
701000000020	80	085.0 - 107.0	16	6	88,04
701000000030	100	107.0 - 132.0	16	6	106,15
701000000035	125	132.0 - 158.0	16	6	135,33
701000000045	150	158.0 - 184.0	16	6	142,92
701000000050	175	189.0 - 212.0	16	6	174,45
701000000055	200	218.0 - 244.0	16	6	192,72
701000000065	225	243.0 - 269.0	16	6	229,31
701000000070	250	266.0 - 295.0	16	6	257,86
701000000075	300	315.0 - 349.0	16	6	291,28
701000000090	350	351.0 - 368.0	16	6	1060,11
701000000095	350	374.5 - 391.5	16	6	1060,11
701000000096	350	386.0 - 403.0	16	6	1050,55
701000000097	350	394.3 - 411.3	16	6	1050,55
701000000098	400	404.8 - 421.8	16	6	1148,84
701000000099	400	412.0 - 429.0	16	6	1148,84
701000000100	400	418.2 - 435.2	16	6	1148,84
701000000101	400	425.0 - 442.0	16	6	1117,23
701000000102	400	434.5 - 451.5	16	6	1395,78
701000000103	400	439.0 - 456.0	16	6	1148,84
701000000104	450	447.0 - 464.0	16	6	1229,53
701000000105	450	455.0 - 472.0	16	6	1229,53
701000000106	450	467.0 - 484.0	16	6	1229,53
701000000110	450	476.0 - 493.0	16	6	1229,53
701000000111	450	487.0 - 504.3	16	6	1383,20
701000000112	450	492.0 - 509.0	16	6	1229,53
701000000115	450	501.9 - 518.9	16	6	1383,20
701000000118	500	510.0 - 527.0	16	6	1388,42
701000000119	500	515.0 - 532.0	16	6	1561,90
701000000120	500	527.0 - 545.0	16	6	1350,24
701000000121	500	546.0 - 563.0	16	6	1350,24
701000000122	500	555.3 - 572.3	16	6	
701000001122	500	565.0 - 582.0	16	6	1518,92
701000002122	500	582.2 - 599.2	16	6	1561,90
701000003122	550	593.0 - 610.0	16	6	1377,53
701000000123	600	601.0 - 618.0	16	6	1561,90
701000000124	600	613.0 - 630.0	16	6	1477,08
701000000125	600	630.0 - 647.0	16	6	1477,08
701000000126	600	654.0 - 671.0	16	6	1477,08
701000000130	600	662.0 - 679.0	16	6	1719,45
701000000131	600	675.0 - 692.0	16	6	1477,08
701000000132	600	689.0 - 706.0	16	6	1610,93
701000000133	600	695.0 - 712.0	16	6	1610,93

* Precios con Junta de EPDM, para Nitrilo consultar

Materia: Cuerpo de fundición revestido con Rilsan Nylon 11.

Revestimiento de tornillos y tuercas: Sheraplex.

Juntas: EPDM para Aplicaciones en Agua, Nitrilo para Aplicaciones en Gas.

MAXIFIT-XTRA - UNIONES

Uniones de gran tolerancia (iguales que Maxi-fit) pero con un 50% más de longitud para incrementar seguridad de unión. Disponibles desde DN50 a DN300



Aplicación



Válido para



MAXISTEP - UNIONES REDUCIDAS

Ref.	DN	Tolerancia (mm)		Presión Máx. de Trabajo (bar)		€/Ud.
		Extremo Peq.	Extremo Gran.	Agua	Gas	
70300000010	050 / 065	057.0 - 074.0	063.0 - 085.0	16	6	221,32
70300000015	050 / 080	057.0 - 074.0	085.0 - 107.0	16	6	230,73
70300000016	065 / 080	063.0 - 085.0	085.0 - 107.0	16	6	233,49
70300000020	080 / 100	085.0 - 107.0	107.0 - 132.0	16	6	240,82
70300000040	100 / 125	107.0 - 132.0	132.0 - 158.0	16	6	252,12
70300000050	125 / 150	132.0 - 158.0	158.0 - 184.0	16	6	280,31
70300000065	150 / 175	158.0 - 184.0	189.0 - 212.0	16	6	332,25
70300000075	175 / 200	189.0 - 212.0	218.0 - 244.0	16	6	421,48
70300000080	200 / 225	218.0 - 244.0	243.0 - 269.0	16	6	484,98
70300000085	225 / 250	243.0 - 269.0	266.0 - 295.0	16	6	495,59
70300000090	300 / 350	315.0 - 332.0	351.0 - 368.0	16	6	1969,32
70300000095	300 / 350	315.0 - 332.0	367.0 - 384.0	16	6	2057,11
70300000100	350 / 350	351.0 - 368.0	374.5 - 391.5	16	6	2325,77
70300000115	350 / 350	374.5 - 391.5	394.3 - 411.3	16	6	1284,49
70300000116	350 / 400	374.5 - 391.5	412.0 - 429.0	16	6	2550,43
70300000117	350 / 400	386.0 - 403.0	412.0 - 429.0	16	6	1348,98
70300000118	350 / 400	394.3 - 411.3	404.8 - 421.8	16	6	2507,81
703000002118	350 / 400	394.3 - 411.3	418.2 - 435.2	16	6	1348,98
703000003118	350 / 400	394.3 - 411.3	425.0 - 442.0	16	6	2626,58
703000000119	400 / 400	404.8 - 421.8	418.2 - 435.2	16	6	1348,98
703000000120	400 / 400	404.8 - 421.8	425.0 - 442.0	16	6	1373,73
703000000121	400 / 400	404.8 - 421.8	434.5 - 451.4	16	6	2681,68
703000000122	400 / 400	412.0 - 429.0	425.0 - 442.0	16	6	2626,58
703000000123	400 / 400	418.2 - 435.2	434.5 - 451.4	16	6	2681,68
703000000125	400 / 400	425.0 - 442.0	434.5 - 451.4	16	6	1373,73
703000000130	400 / 400	425.0 - 442.0	447.2 - 464.2	16	6	1373,73
703000000131	400 / 400	439.0 - 456.0	467.0 - 484.0	16	6	1476,26
703000000135	400 / 450	425.0 - 442.0	455.0 - 472.0	16	6	2927,78
703000000136	400 / 450	425.0 - 442.0	476.0 - 493.0	16	6	2995,94
703000000137	400 / 450	425.0 - 442.0	487.3 - 504.3	16	6	3681,93
703000001137	400 / 500	425.0 - 442.0	555.3 - 572.3	16	6	3744,85
703000002137	400 / 500	425.0 - 442.0	565.0 - 582.0	16	6	1480,08
703000002138	450 / 450	447.2 - 464.2	455.0 - 472.0	16	6	2804,62
703000000139	450 / 450	447.2 - 464.2	476.0 - 493.0	16	6	2927,78
703000000140	450 / 450	476.0 - 493.0	487.3 - 504.3	16	6	1632,58
703000000145	450 / 450	476.0 - 493.0	501.9 - 518.9	16	6	1632,58
703000000150	450 / 450	476.0 - 493.0	510.0 - 527.0	16	6	1632,58
703000000151	450 / 500	492.0 - 509.0	527.0 - 544.0	16	6	1994,28
703000000154	500 / 500	510.0 - 527.0	527.0 - 544.0	16	6	1994,28
703000000155	500 / 500	527.0 - 544.0	540.1 - 557.1	16	6	1805,83
703000000160	500 / 500	527.0 - 544.0	555.3 - 572.3	16	6	1805,83



Aplicación



Válido para

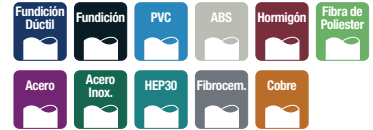

MAXISTEP - UNIONES REDUCIDAS

Ref.	DN	Tolerancia (mm)		Presión Máx. de Trabajo (bar)		€/Ud.
		Extremo Peq.	Extremo Gran.	Agua	Gas	
70300000165	500 / 500	527.0 - 544.0	566.5 - 583.5	16	6	1805,83
70300000170	500 / 500	527.0 - 544.0	582.2 - 599.2	16	6	1805,83
70300000171	500 / 600	527.0 - 544.0	598.0 - 615.0	16	6	3956,90
703000001171	500 / 600	527.0 - 544.0	601.0 - 618.0	16	6	3977,97
703000002171	500 / 500	546.0 - 563.0	590.5 - 607.5	16	6	1899,74
703000003171	500 / 500	565.0 - 582.0	582.2 - 599.2	16	6	3854,85
703000000172	600 / 600	601.0 - 618.0	630.0 - 647.0	16	6	1899,74
703000000173	600 / 600	601.0 - 618.0	645.2 - 662.2	16	6	1899,74
703000000174	600 / 600	618.0 - 635.0	630.0 - 647.0	16	6	1899,74
703000000175	600 / 600	630.0 - 647.0	645.2 - 662.2	16	6	1899,74
703000000180	600 / 600	630.0 - 647.0	662.0 - 679.0	16	6	1899,74
703000000185	600 / 600	630.0 - 647.0	675.0 - 692.0	16	6	1899,74
703000000186	600 / 600	654.0 - 671.0	710.0 - 727.0	16	6	2216,53
703000000190	700 / 700	733.0 - 750.0	741.0 - 758.0	16	6	2435,13

* Precios con Junta de EPDM, para Nitrilo consultar



Aplicación



Válido para



MAXIDAPTOR - ADAPTADORES DE BRIDA

Ref.	DN	Tolerancia (mm)	Brida		Presión Máx. de Trabajo (bar)		€/Ud.
			DN	Taladro PN	Agua	Gas	
702000000005	50	057.0 - 074.0	50	10 / 16	16	6	74,92
702000000010	65	063.0 - 085.0	60 / 65 / 80	10 / 16	16	6	97,52
702000000020	80	085.0 - 107.0	80	10 / 16	16	6	99,17
702000000030	100	107.0 - 132.0	100	10 / 16	16	6	104,00
702000000035	125	132.2 - 158.0	125 / 150	10 / 16	16	6	140,89
702000000045	150	158.0 - 184.0	150	10 / 16	16	6	143,86
702000000050	175	189.0 - 212.0	200	10 / 16	16	6	191,91
702000000055	200	218.0 - 244.0	200	10 / 16	16	6	201,40
702000000060	225	243.0 - 269.0	250	10 / 16	16	6	251,82
702000000065	250	266.0 - 295.0	250	10 / 16	16	6	266,62
702000000070	300	315.0 - 349.0	300	10 / 16	16	6	315,19
702000000075	350	348.5 - 365.5	350	16	16	6	1335,32
702000000080	350	351.0 - 368.0	350	10	16	6	1335,32
702000000084	350	351.0 - 368.0	350	16	16	6	1335,32
702000000085	350	374.5 - 391.5	350	10	16	6	1335,32
702000000090	350	374.5 - 391.5	350	16	16	6	1335,32
702000000095	350	394.3 - 411.3	350	10	16	6	1422,67
702000000100	350	394.3 - 411.3	350	16	16	6	1422,67
702000000101	350	394.3 - 411.3	400	10	16	6	
702000000102	350	394.3 - 411.3	400	16	16	6	1376,61
702000000104	400	404.8 - 421.8	400	10	16	6	1376,61
702000000105	400	404.8 - 421.8	400	16	16	6	1376,61
702000000106	400	418.2 - 435.2	400	10	16	6	1376,61
702000000107	400	418.2 - 435.2	400	16	16	6	1376,61
702000000108	400	425.0 - 442.0	400	10	16	6	1376,61
702000000110	400	425.0 - 442.0	400	16	16	6	1376,61
702000000111	400	434.4 - 451.4	400	10	16	6	1376,61
702000000115	400	434.4 - 451.4	400	16	16	6	1376,61
702000000116	400	447.2 - 464.2	400	10	16	6	1492,37
702000000120	400	447.2 - 464.2	400	16	16	6	1492,37
702000000125	450	455.0 - 472.0	450	10	16	6	1705,09
702000000130	450	455.0 - 472.0	450	16	16	6	1705,09
702000000131	450	476.0 - 493.0	450	10	16	6	1705,09
702000000135	450	476.0 - 493.0	450	16	16	6	1705,09
702000000136	450	487.3 - 504.3	450	10	16	6	1705,09
702000000140	450	487.3 - 504.3	450	16	16	6	1705,09
702000000141	450	501.9 - 518.9	450	10	16	6	1705,09
702000000142	450	501.9 - 518.9	450	16	16	6	1705,09
702000000143	450	510.0 - 527.0	500	10	16	6	1989,19
702000000155	450	510.0 - 527.0	500	16	16	6	1989,19
702000000156	450	501.9 - 518.9	500	10	16	6	1989,19



Aplicación



Válido para



MAXIDAPTOR - ADAPTADORES DE BRIDA

Ref.	DN	Tolerancia (mm)	Brida		Presión Máx. de Trabajo (bar)		€/Ud.
			DN	Taladro PN	Agua	Gas	
702000000145	450	501.9 - 518.9	500	16	16	6	
702000000150	450	510.0 - 527.0	450	10	16	6	
702000000159	500	527.0 - 544.0	500	10	16	6	1989,19
702000000160	500	527.0 - 544.0	500	16	16	6	1989,19
702000000161	500	540.1 - 557.1	500	10	16	6	1989,19
702000000165	500	540.1 - 557.1	500	16	16	6	1989,19
702000000166	500	555.3 - 572.3	500	10	16	6	1989,19
702000000170	500	555.3 - 572.3	500	16	16	6	1989,19
702000000171	500	566.5 - 583.5	500	10	16	6	1989,19
702000000175	500	566.5 - 583.5	500	16	16	6	1989,19
702000000180	500	582.2 - 599.2	500	10	16	6	2101,85
702000000185	500	582.2 - 599.2	500	16	16	6	2279,97
702000000187	600	601.0 - 618.0	600	10	16	6	2364,00
702000000188	600	601.0 - 618.0	600	16	16	6	2364,00
702000000189	600	630.5 - 647.5	600	10	16	6	2364,00
702000000190	600	630.5 - 647.5	600	16	16	6	2364,00
702000000191	600	645.2 - 662.2	600	10	16	6	2364,00
702000000195	600	645.2 - 662.2	600	16	16	6	2364,00
702000000196	600	662.0 - 679.0	600	10	16	6	2364,00
702000000200	600	662.0 - 679.0	600	16	16	6	2364,00

* Precios con Junta de EPDM, para Nitrilo consultar



Aplicación



Válido para



ULTRAGRIP - UNIONES DE GRAN TOLERANCIA

Ref.	DN	Tolerancia (mm)	Presión Máx. de Trabajo (bar)		€/Ud.*
			Agua	Gas	
150050000010	40	043.5 - 063.5	16	4	322,03
150040000000	50	048.0 - 071.0	16	4	349,06
150065000020	65	063.0 - 083.7	16	4	376,24
150080000030	80	085.7 - 107.0	16	4	431,96
150100000040	100	107.2 - 133.2	16	4	508,16
150125000050	125	132.2 - 160.2	16	4	696,57
150150000060	150	158.2 - 192.2	16	4	867,33
150175000070	175	192.2 - 226.9	16	4	1189,67
150200000080	200	218.1 - 256.0	16	4	1291,94
150250000090	250	266.2 - 310.0	16	4	1663,24
150300000100	300	315.0 - 356.0	16	4	1977,26
150350000110	350	352.2 - 396.0	10	4	3335,74
150400000120	400	398.2 - 442.0	10	4	3591,02
150450000130	450	448.0 - 492.0	10	**	5428,86
150500000140	500	498.0 - 552.0	10	**	6540,68
150500000141	500	558.0 - 608.0	10	**	7251,05
150600000150	600	604.0 - 648.0	10	**	8062,78
150600000151	600	676.0 - 726.0	10	**	8632,29
150700000160	700	700-735	16	**	
150700000161	700	727-762	16	**	
150700000162	700	750-785	16	**	
150800000170	800	789 - 824	16	**	
150800000171	800	825 - 860	16	**	
150800000172	800	853 - 888	16	**	

* Precios con Junta de EPDM, para Nitrilo consultar

** No apto para gas

Permite convertirla en no autoblocante.

Utiliza misma mordaza para todo tipo de materiales compatibles. Para aplicaciones en PE y PVC.

Material: Cuerpo de fundición revestido con Rilsan Nylon 11.

Revestimiento de tornillos: Capa de lubricante en seco.

Revestimiento de tuercas: Decromet.

Mordaza: Copolímero de Acetal.

Deflexión angular de hasta 8°.

Juntas: EPDM para Aplicaciones en Agua, Nitrilo para Aplicaciones en Gas.



Aplicación



Válido para



ULTRAGRIP - UNIONES REDUCIDAS DE GRAN TOLERANCIA

Ref.	DN	Tolerancia (mm)		Presión Máx. de Trabajo (bar)		€/Ud.*
		Extremo Peq.	Extremo Gran.	Agua	Gas	
152032040000	032 / 040	036.0 - 046.0	043.5 - 063.5	16	4	401,00
152080100000	080 / 100	085.7 - 107.0	107.2 - 133.2	16	4	577,70
152100125000	100 / 125	107.2 - 133.2	132.2 - 160.2	16	4	663,50
152100150000	100 / 150	107.2 - 133.2	158.2 - 192.2	16	4	833,49
152125150000	125 / 150	132.2 - 160.2	158.2 - 192.2	16	4	865,90
152150175000	150 / 175	158.2 - 192.2	192.9 - 226.2	16	4	1130,62
152175200000	175 / 200	192.9 - 226.9	218.1 - 256.0	16	4	1425,33
152200250000	200 / 250	218.1 - 256.0	266.2 - 310.0	16	4	1673,49
152250300000	250 / 300	266.2 - 310.0	315.0 - 356.0	16	4	2046,37
152400450000	400 / 450	398.0 - 442.0	448.0 - 492.0	10	**	4271,89
152500500000	500 / 500	498.0 - 552.0	558.0 - 608.0	10	**	5378,39
152600000000	600 / 600	604.0 - 648.0	676.0 - 726.0	10	**	7244,84

* Precios con Junta de EPDM, para Nitrilo consultar.

** No apto para gas

Permite convertirla en no autoblocante.

Utiliza misma mordaza para todo tipo de materiales compatibles. Para aplicaciones en PE y PVC.

Material: Cuerpo de fundición revestido con Rilsan Nylon 11.

Revestimiento de tornillos: Capa de lubricante en seco.

Revestimiento de tuercas: Decromet.

Mordaza: Copolímero de Acetal.

Deflexión angular de hasta 8°.

Juntas: EPDM para Aplicaciones en Agua, Nitrilo para Aplicaciones en Gas.



Aplicación



Válido para



ULTRAGRIP - ADAPTADORES DE BRIDAS DE GRAN TOLERANCIA

Ref.	DN	Tolerancia (mm)	Brida		Presión Máx. de Trabajo (bar)		€/Ud.*
			DN	Taladro PN	Agua	Gas	
15105000010	40	043.5 - 063.5	50	10 / 16	16	4	277,57
15104000000	50	048.0 - 071.0	50	10 / 16	16	4	325,79
15106500020	65	063.0 - 083.7	65	10 / 16	16	4	338,97
15108000030	80	085.7 - 107.0	80	10 / 16	16	4	391,64
15110000040	100	107.2 - 133.2	100	10 / 16	16	4	484,47
15112500050	125	132.2 - 160.2	125	10 / 16	16	4	613,94
15115000060	150	158.2 - 192.2	150	10 / 16	16	4	734,01
15117500070	175	192.2 - 226.9	200	10 / 16	16	4	944,37
15120000080	200	218.1 - 256.0	200	10 / 16	16	4	1018,63
15125000090	250	266.2 - 310.0	250	10 / 16	16	4	1329,14
15130000100	300	315.0 - 356.0	300	10 / 16	16	4	1645,92
15135000110	350	352.2 - 396.0	350	10 / 16	10	4	2564,30
15140000120	400	398.2 - 442.0	400	10 / 16	10	4	2926,04
15140000121	450	448.0 - 492.0	400	10 / 16	10	**	4426,26
15150000130	500	498.0 - 552.0	500	10 / 16	10	**	5269,38
15150000131	500	558.0 - 608.0	500	10 / 16	10	**	5659,72
15160000140	600	604.0 - 648.0	600	10 / 16	10	**	6466,58
15160000141	600	676.0 - 726.0	600	10 / 16	10	**	7356,93
15170000150	700	700-735	700	10 / 16	16	**	
15170000151	700	727-762	700	10 / 16	16	**	
15170000152	700	750-785	700	10 / 16	16	**	
15180000160	800	789 - 824	800	10 / 16	16	**	
15180000161	800	825 - 860	800	10 / 16	16	**	
15180000162	800	853 - 888	800	10 / 16	16	**	

* Precios con Junta de EPDM, para Nitrilo consultar.

** No apto para gas

Permite convertirla en no autoblocante.

Utiliza misma mordaza para todo tipo de materiales compatibles. Para aplicaciones en PE y PVC.

Material: Cuerpo de fundición revestido con Rilsan Nylon 11.

Revestimiento de tornillos: Capa de lubricante en seco.

Revestimiento de tuercas: Decromet.

Mordaza: Copolímero de Acetal.

Deflexión angular de hasta 8°.

Juntas: EPDM para Aplicaciones en Agua, Nitrilo para Aplicaciones en Gas.

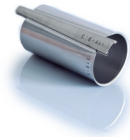

Aplicación



Válido para



ULTRAGRIP - CASQUILLOS ALINEADORES DE ACERO

SDR11

Ref.	Ø	€/Ud.
153040011100	40	
153050011100	50	35,89
153063011100	63	
153075011100	75	
153090011100	90	
153110011100	110	
153125011100	125	
153140011100	140	
153160011100	160	
153180011100	180	
153200011100	200	
153225011100	225	
153250011100	250	
153280011100	280	
153315011100	315	
153355011100	355	
153400011100	400	
153450011100	450	
153500011100	500	
153560011100	560	
153630011100	630	
156710011100	710	

SDR17

Ref.	Ø	€/Ud.
153063017100	63	
153075017100	75	
153090017100	90	115,91
153110017100	110	91,83
153125017100	125	
153140017100	140	
153160017100	160	
153180017100	180	
153200017100	200	
153225017100	225	
153250017100	250	
153280017100	280	
153315017100	315	
153355017100	355	
153400017100	400	
153450017100	450	
153500017100	500	
153560017100	560	
153630017100	630	
153710017100	710	

Para aplicaciones con PE y PVC es necesario el uso de casquillos alineadores en toda la gama ULTRAGRIP



Aplicación



Válido para



QUICKFIT - UNIONES

Ref.	DN	Ø Tubo	Presión Máx.Trabajo (bar)	€/Ud.*
720000040040	40	047.9 - 051.3	40	159,11
720000040050	50	059.5 - 063.3	40	203,51
720000040065	65	075.3 - 079.1	40	267,93
720000040080	80	088.1 - 091.9	40	292,02
721000040080	80	095.8 - 100.2	40	292,02
720000040100	100	107.2 - 111.0	40	353,78
721000040100	100	113.5 - 120.2	40	353,78
720000040125	125	138.9 - 142.7	40	453,81
720000025150	150	158.2 - 162.0	25	501,31
721000025150	150	167.5 - 172.3	25	501,31
720000025175	175	192.2 - 196.7	25	515,24
720000025200	200	218.3 - 224.4	25	587,83
720000025250	250	272.2 - 276.5	25	694,35
720000025300	300	323.1 - 328.6	25	848,33

* Precios con Junta de EPDM, para Nitrilo consultar.

Especialmente diseñados para grandes presiones (hasta 46 bar).

Material: Cuerpo de fundición revestido con Rilsan Nylon 11.

Revestimiento de tornillos y tuercas: Sheraplex.

Juntas: EPDM para Aplicaciones en Agua, Nitrilo para Aplicaciones en Gas.



Aplicación



Válido para



QUICKFIT - ADAPTADORES DE BRIDA

Ref.	DN	Ø Tubo	Material	Brida		€/Ud.*
				DN	Taladro PN	
722000000050	50	059.5 - 063.3	Acero/PVC /PVCu	50	10/16/25/40	298,15
722000000065	65	075.3 - 079.1	Acero	65	10/16	387,03
722000000080	80	088.1 - 091.9	Acero/PVC /PVCu	80	10/16/25/40	446,05
723000000080	80	095.8 - 100.2	Fund. Dúctil	80	10/16/25/40	446,05
722000000100	100	107.2 - 111.0	Acero/PVC	100	10/16	474,55
723000000100	100	113.5 - 120.2	Acero/PVCu/Fund. Dúctil	100	10/16	474,55
722000000125	125	138.9 - 142.7	Acero/PVC/PVCu	125	10/16	531,22
722000000150	150	158.2 - 162.0	Acero/PVC/PVCu	150	10/16	605,14
723000000150	150	167.5 - 172.3	Acero/Fund. Dúctil	150	10/16	605,14
722000000200	200	192.2 - 196.7	Acero/PVCu	200	10/16	717,75
723000000200	200	218.3 - 224.4	Acero/PVCu/Fund. Dúctil	200	10/16	827,30
722000000250	250	272.2 - 276.5	Acero/PVCu/Fund. Dúctil	250	10/16	1091,52
722000000300	300	323.1 - 328.6	Acero/PVCu/Fund. Dúctil	300	10/16	1325,55

* Precios con Junta de EPDM, para Nitrilo consultar.

Especialmente diseñados para grandes presiones (hasta 46 bar).

Material: Cuerpo de fundición revestido con Rilsan Nylon 11.

Revestimiento de tornillos y tuercas: Sheraplex.

Juntas: EPDM para Aplicaciones en Agua, Nitrilo para Aplicaciones en Gas.



Aplicación



Válido para

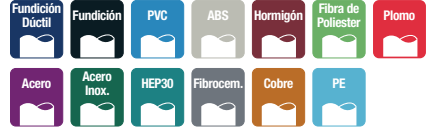

CARRETES DE DESMONTAJE

Ref.	DN	PN Brida	€/Ud.*
17000050100	50	10 / 16	357,72
17000065100	65	10 / 16	372,53
17000080100	80	10 / 16	434,07
170000100100	100	10 / 16	478,14
170000125100	125	10 / 16	609,09
170000150100	150	10 / 16	716,14
170000200110	200	10	955,84
170000200116	200	16	1032,20
170000250110	250	10	1281,78
170000250116	250	16	1423,87
170000300110	300	10	1394,44
170000300116	300	16	1550,25
170000350110	350	10	1768,91
170000350116	350	16	1966,37
170000400110	400	10	2169,23
170000400116	400	16	2412,60
170000450110	450	10	2412,60
170000450116	450	16	2688,52
170000500110	500	10	2940,00
170000500116	500	16	3272,74
170000600110	600	10	3567,50
170000600116	600	16	3973,30
170000700110	700	10	4222,07
170000700116	700	16	4711,66
170000800110	800	10	5558,25
170000800116	800	16	6169,47
170000900110	900	10	6610,32
170000900116	900	16	7340,71
170001000110	1000	10	11775,23
170001000116	1000	16	13079,48
170001100110	1100	10	15821,34
170001100116	1100	16	20998,55
170001200110	1200	10	29797,87
170001200116	1200	16	35227,00
170001400110	1400	10	36747,13
170001400116	1400	16	39540,52
170001500110	1500	10	44139,52
170001500116	1500	16	47459,71
170001600110	1600	10	52166,22
170001600116	1600	16	56092,87
170001800110	1800	10	70201,82
170001800116	1800	16	75452,39
170002000110	2000	10	88365,77
170002000116	2000	16	95078,88

* Otras presiones consultar

Para válvulas, bombas y medidores.
Posibilidad de otras dimensiones y PN bajo petición.
Material: Acero revestido con Rilsan Nylon 11.



Aplicación



Válido para



HANDICLAMP - ABRAZADERAS SIMPLES DE REPARACIÓN EN ACERO INOXIDABLE

DN	Tolerancia (mm)	Presión Máx. de Trabajo (bar)		L-150 mm		L-200 mm	
		Agua	Gas	Ref.	€/Ud	Ref.	€/Ud
32	044.0 - 048.0	24	6	706000000004	116,76	706000200004	100,94
32	048.0 - 052.0	24	6	706000000005	90,15	706000200005	101,83
40	054.0 - 058.0	24	6	706000000010	90,15	706000200010	101,83
40	058.0 - 064.0	24	6	706000000014	91,72	706000200014	106,52
50	060.0 - 067.0	24	6	706000000015	91,72	706000200015	106,52
50	063.0 - 070.0	24	6	706000000016	91,72	706000200016	106,52
50	068.0 - 076.0	24	6	706000000020	93,94	706000200020	108,73
65	075.0 - 083.0	24	6	706000000035	97,39	706000200035	112,83
65	082.0 - 089.0	20	5	706000000040	97,39	706000200040	112,83
80	087.0 - 096.0	20	5	706000000045	99,04	706000200045	113,88
80	095.0 - 105.0	20	5	706000000055	100,34	706000200055	115,00
90	102.0 - 112.0	20	5	706000150060	100,76	706000000060	128,99
100	113.0 - 123.0	20	5	706000150075	103,65	706000000075	132,24
100	120.0 - 130.0	16	4	706000150085	117,91	706000000085	135,77
125	132.0 - 142.0	16	4	-	-	706000000095	137,86
125	135.0 - 145.0	16	4	-	-	706000000100	137,86
125	147.0 - 157.0	16	4	-	-	706000000105	144,66
150	151.0 - 161.0	16	4	-	-	706000000110	145,84
150	160.0 - 170.0	16	4	-	-	706000000115	145,84
150	167.0 - 178.0	16	4	-	-	706000000125	148,52
150	176.0 - 187.0	16	4	-	-	706000000140	155,24
175	186.0 - 196.0	16	4	-	-	706000000150	165,06
175	193.0 - 203.0	16	4	-	-	706000000155	165,63
175	200.0 - 210.0	16	4	-	-	706000000160	165,63
200	215.0 - 225.0	16	4	-	-	706000000170	180,46
200	219.0 - 229.0	16	4	-	-	706000000175	180,46
225	230.0 - 240.0	10	2,5	-	-	-	-
225	237.0 - 247.0	10	2,5	-	-	-	-
225	240.0 - 250.0	10	2,5	-	-	-	-
225	250.0 - 260.0	10	2,5	-	-	-	-
225	257.0 - 267.0	10	2,5	-	-	-	-

También disponibles en L-300 mm y L-400 mm

225	261.0 - 271.0	10	2,5	-	-	-	-
250	270.0 - 280.0	10	2,5	-	-	-	-
250	280.0 - 291.0	6	1,5	-	-	-	-
250	290.0 - 300.0	6	1,5	-	-	-	-
300	300.0 - 310.0	6	1,5	-	-	-	-
300	310.0 - 320.0	6	1,5	-	-	-	-
300	315.0 - 325.0	6	1,5	-	-	-	-
300	320.0 - 330.0	6	1,5	-	-	-	-
300	330.0 - 340.0	6	1,5	-	-	-	-
300	340.0 - 350.0	6	1,5	-	-	-	-
300	350.0 - 360.0	6	1,5	-	-	-	-

También disponibles en L-300 mm y L-400 mm



Aplicación



Válido para



HANDICLAMP - ABRAZADERAS DOBLES DE REPARACIÓN EN ACERO INOXIDABLE

DN	Tolerancia (mm)	Presión Máx. de Trabajo (bar)		L-200 mm		L-300 mm	
		Agua	Gas	Ref.	€/Ud	Ref.	€/Ud
80	088.0 - 110.0	20	5	706000000335	201,72	706000300335	298,77
100	108.0 - 128.0	20	5	706000000337	205,60	706000300337	326,32
100	113.0 - 133.0	20	5	706000000338	212,40	706000300338	318,22
100	120.0 - 140.0	20	5	706000000339	212,39	706000300339	312,12
125	130.0 - 150.0	16	4	706000000340	218,01	706000300340	318,04
125	140.0 - 160.0	16	4	706000000342	220,76	706000300342	327,00
150	150.0 - 170.0	16	4	706000000364	225,59	706000300364	335,81
150	159.0 - 180.0	16	4	706000000343	228,56	706000300343	339,41
150	168.0 - 189.0	16	4	706000000346	230,46	706000300346	343,43
150	170.0 - 190.0	16	4	706000000347	230,75	706000300347	342,48
150	175.0 - 195.0	16	4	706000000357	232,81	706000300357	344,28
175	190.0 - 210.0	16	4	706000000348	234,68	706000300348	389,36
200	205.0 - 225.0	16	4	706000000349	260,10	706000300349	346,47
200	210.0 - 230.0	16	4	706000000350	260,10	706000300350	353,29
200	216.0 - 238.0	16	4	706000000351	261,28	706000300351	357,32
200	220.0 - 242.0	10	2,5	706000000352	261,67	706000300352	360,76
225	240.0 - 260.0	10	2,5	706000000353	270,51	706000300353	388,22
225	243.0 - 263.0	10	2,5	706000000354	274,79	706000300354	396,78
225	255.0 - 275.0	10	2,5	706000200205	279,89	706000000205	394,46
250	272.0 - 292.0	10	2,5	706000200215	290,20	706000000215	391,03
250	282.0 - 302.0	6	1,5	706000200220	302,05	706000000220	470,08
250	295.0 - 315.0	6	1,5	706000200225	319,85	706000000225	393,53
300	307.0 - 327.0	6	1,5	-	-	706000000229	394,46
300	315.0 - 335.0	6	1,5	-	-	706000000230	428,50
300	319.0 - 339.0	6	1,5	-	-	706000000234	428,50
300	322.0 - 344.0	6	1,5	-	-	706000000235	449,63
300	333.0 - 353.0	6	1,5	-	-	706000000413	452,24
300	341.0 - 361.0	6	1,5	-	-	706000000362	478,75
350	365.0 - 385.0	5	1,3	-	-	706000000363	499,77

También disponibles en L-300 mm y L-400 mm



Aplicación



Válido para



HANDICLAMP - ABRAZADERAS TRIPLES DE REPARACIÓN EN ACERO INOXIDABLE (L-400)

Ref.	Tolerancia	€/Ud.*
706000000240	340.0 - 370.0	
706000000423	385.0 - 415.0	747,30
706000000245	395.0 - 425.0	864,44
706000000250	440.0 - 470.0	888,32
706000000255	475.0 - 505.0	1432,79
706000000260	530.0 - 560.0	1719,35
706000000421	535.0 - 565.0	2736,28

Válvulas

Trampillones

Accesorios

Ventosas

Hidrantes y bocas de riego

Collarines, abrazaderas, tomas en carga

Bridas

Válvulas y accesorios de fundición

INFRAESTRUCTURA





Válvulas y accesorios de fundición

Válvulas de compuerta



* Para válvulas de cierre elástico
** ACS sólo para válvulas azules



* Para válvulas de cierre elástico
** ACS sólo para válvulas azules

NEXUS - VÁLVULAS DE COMPUERTA DE CIERRE ELÁSTICO CON BRIDAS CORTAS

Serie 14 - PN16

Referencia	DN	PN	€/Ud.
10729010	50	10/16	139,88
10729015	65	10/16	174,66
10729020	80	10/16	181,95
10729025	100	10/16	225,50
10729030	125	10/16	330,61
10729035	150	10/16	369,21
10729040	200	10	CONSULTAR
10729045	200	16	630,65
10729050	250	10	CONSULTAR
10729055	250	16	CONSULTAR
10729060	300	10	CONSULTAR
10729065	300	16	CONSULTAR

Disponible en PN10 y PN16
Con eje en acero inoxidable AISI 316 L +10%
Juntas en EPDM
Bajo pedido juntas en NBR

También disponible en color rojo para saneamiento y aguas residuales.
PRECIOS CONSULTAR



NEXUS - VÁLVULAS DE COMPUERTA DE CIERRE ELÁSTICO CON BRIDAS LARGAS

Serie 15 - PN16

Referencia	DN	PN	€/Ud.
10733010	50	10/16	158,24
10733015	65	10/16	180,02
10733020	80	10/16	202,95
10733025	100	10/16	246,16
10733030	125	10/16	370,76
10733035	150	10/16	436,10
10733040	200	10	CONSULTAR
10733045	200	16	720,49
10733050	250	10	CONSULTAR
10733055	250	16	CONSULTAR
10733060	300	10	CONSULTAR
10733065	300	16	CONSULTAR

Disponible en PN10 y PN16
Con eje en acero inoxidable AISI 316 L +10%
Juntas en EPDM
Bajo pedido juntas en NBR

También disponible en color rojo para saneamiento y aguas residuales.
PRECIOS CONSULTAR



* Para válvulas de cierre elástico
** ACS sólo para válvulas azules



También disponible en color rojo para saneamiento y aguas residuales. **PRECIOS CONSULTAR**
Cierre izquierda disponible bajo pedido

MODELO 3000 - VÁLVULAS DE COMPUERTA DE CIERRE ELÁSTICO CON BRIDAS

Serie 14 - PN16

Referencia	DN	€/Ud.
666040000001	40	152,50
666050000001	50	152,50
666060000001	60	191,11
666065000001	65	191,11
666080000001	80	201,04
666100000001	100	245,00
666125000001	125	362,70
666150000001	150	405,14
666200000001	200	722,36

Referencia	DN	€/Ud.
666250000001	250	1.100,76
666300000001	300	1.578,53
666350000001	350	3.783,88
666400000001	400	4.739,41
666450000001	450	7.911,74
666500000001	500	8.561,48

Disponibles en PN10 y PN16
Con eje en acero inoxidable AISI 316 L +10%
Cierre izquierda disponible bajo pedido
Juntas en EPDM
Bajo pedido juntas en NBR



* Para válvulas de cierre elástico
** ACS sólo para válvulas azules

NEXUS BLOCKPLUS - VÁLVULAS DE COMPUERTA DE CIERRE ELÁSTICO CON EXTREMOS ANTITRACCIÓN PARA TUBOS DE PE/PVC

PN16

Referencia	DN	DN ext. Tubo	€/Ud.
10720700	50	63	449,11
10720705	65	75	511,97
10720710	80	90	565,86
10720714	100	110	718,56
10720720	125	125	988,02
10720725	150	160	1.149,69
10720730	200	200	1.706,58

Con eje en acero inoxidable AISI 316 L +10%
Juntas en EPDM
Bajo pedido juntas en NBR



* Para válvulas de cierre elástico
** ACS sólo para válvulas azules

MODELO 3000 - VÁLVULAS DE COMPUERTA DE CIERRE ELÁSTICO CON BRIDAS

Serie 15 - PN25

Referencia	DN	€/Ud.
666040025001	40	317,23
666050025001	50	317,23
666060025001	60	359,27
666065025001	65	359,27
666080025001	80	428,08
666100025001	100	500,69
666125025001	125	722,36
666150025001	150	848,51
666200025001	200	1.230,71
666250025001	250	1.972,20
666300025001	300	2.870,39

Con eje en acero inoxidable AISI 316 L +10%
Cierre izquierda disponible bajo pedido
Juntas en EPDM
Bajo pedido juntas en NBR



* Para válvulas de cierre elástico
** ACS sólo para válvulas azules



También disponible en color rojo para saneamiento y aguas residuales. **PRECIOS CONSULTAR**
Cierre izquierda disponible bajo pedido

MODELO 3000 - VÁLVULAS DE COMPUERTA DE CIERRE ELÁSTICO CON BRIDAS

Serie 15 - PN16

Referencia	DN	€/Ud.
666040000002	40	173,89
666050000002	50	173,89
666060000002	60	198,75
666065000002	65	198,75
666080000002	80	223,58
666100000002	100	271,37
666125000002	125	408,96
666150000002	150	477,76
666200000002	200	795,00

Referencia	DN	€/Ud.
666250000002	250	1.246,02
666300000002	300	2.048,64
666350000002	350	4.296,03
666400000002	400	4.968,72
666450000002	450	8.630,30
666500000002	500	9.306,79
666600000002	600	14.906,16

Disponible en PN10 y PN16
Con eje en acero inoxidable AISI 316 L +10%
Cierre izquierda disponible bajo pedido
Juntas en EPDM
Bajo pedido juntas en NBR

Válvulas y accesorios de fundición

Válvulas de compuerta / Válvulas de acometida



MODELO 3000 - VÁLVULAS DE COMPUERTA METÁLICA

PN40

Referencia	DN	€/Ud.
666040040008	40	490,41
666050040008	50	556,85
666060040008	60	650,28
666065040008	65	650,28
666080040008	80	858,68
666100040008	100	1.185,62
666125040008	125	1.602,38
666150040008	150	2.073,01
666200040008	200	3.434,68
666250040008	250	5.205,92
666300040008	300	6.314,30
666350040008	350	11.365,72
666400040008	400	15.319,56
666450040008	450	16.817,74
666500040008	500	27.430,78
666600040008	600	32.889,99
666700040008	700	57.663,95



SÉCULO XXI - VÁLVULAS DE ACOMETIDA REGISTRO CON UNIONES ROSCADAS

PN10 - PN16

Referencia	Ø x Rh	€/Ud.
666020025002	20 - ¾"	75,30
666025032002	25 - 1"	75,30
666032040002	32 - 1 ¼"	113,50
666040050002	40 - 1 ½"	113,50
666050063002	50 - 2"	140,64

Con eje en acero inoxidable AISI 316 L +10%



SÉCULO XXI - VÁLVULAS DE ACOMETIDA REGISTRO CON UNIONES ROSCADAS

PN10 - PN16

Referencia	Ø x Rh	€/Ud.
666025032003	25/ 1" - 1 ¼"	152,71
666032040003	32/1 ¼" - 2"	179,63
666040050003	40/ 1 ½" - 2"	215,57
666050063003	50/ 2" - 2"	269,46

Con eje en acero inoxidable AISI 316 L +10%



TRAMPILLONES MODELO TELESCÓPICO

Referencia	Modelo	€/Ud.
E139EBAREC	CUADRADO	46,92
E139EBARER	REDONDO	46,92
E139EBAREH	HEXAGONAL	46,92
E737CLEBAC	LLAVE DE CIERRE	89,36



Un solo cuerpo



3 tapas diferentes = Reducción de stocks

TRAMPILLONES COMPOSITE

Referencia	Modelo	€/Ud.
E139EBA4ER	REDONDO	25,46
E139EBA4EC	CUADRADO	25,46
E139EBA4EE	HEXAGONAL	25,46
E737CLEBAC	LLAVE DE CIERRE	89,36



CUADRADILLO

Referencia	DN	€/Ud.
666020050027	20-¾" / 25-1" / 32 1 ¼" / 40-1 ½" / 50-2"	16,17
666040050027	40-50	16,17
666060080027	60-65-80	16,17
666100150027	100-125-150	16,17
666200200027	200	19,77
666250300027	250-300	21,57
666350500027	350-400-450-500	41,31
666600600027	600	89,83



VOLANTE

Referencia	DN	€/Ud.
666020050008	20-¾" / 25-1" / 32 1 ¼" / 40-1 ½" / 50-2"	19,12
666040050006	40-50	19,12
666065080006	60-65-80	21,00
666100100006	100	21,00
666125150006	125-150	38,21
666200200006	200	76,45
666250250006	250	107,03
666300300006	300	126,11
666350400006	350-400	152,89
666450500006	450-500	191,11
666600600006	600	267,53



OBTURADOR ANTIRROBO

Referencia	DN	€/Ud.
10720101	20-¼" / 25-1" / 32-1 ¼" / 40-1 ½" / 50-2"	89,82
	Otros DN	CONSULTAR



LLAVE PARA OBTURADOR ANTIRROBO

Referencia	DN	€/Ud.
10720100	20-¼" / 25-1" / 32-1 ¼" / 40-1 ½" / 50-2"	574,84
	Otros DN	CONSULTAR



EJE TELESCÓPICO 1 METRO

Referencia	DN	€/Ud.
666020050013	20-25-32-40-50	79,11
666040050013	40 - 50	79,11
666060080013	60-65-80	79,11
666100100013	100	79,11
666125150013	125-150	79,11
666200200013	200	79,11
666250300013	250-300	105,11
666350350013	350	105,11
666400400013	400	147,53
666450500013	450/500	147,93
666350500013	350 HASTA 500	147,93
666600600013	600	154,81



LLAVE DE M

Referencia	€/Ud.
10701005	179,63

JLAS



VÁLVULAS DE MARIPOSA MODELO DUPLEX 500

Serie 14 - PN10

Referencia	DN	€/Ud.
66615000012	150	1.770,63
666200010012	200	1.897,45
666250010012	250	2.176,75
666300010012	300	2.507,44
666350010012	350	3.340,59
666400010012	400	3.846,26
666450010012	450	5.514,13
666500010012	500	6.072,78
666600010012	600	7.671,63
666700010012	700	11.403,91
666800010012	800	15.831,29
666900010012	900	22.803,01
666100010012	1000	27.323,47
666110010012	1100	41.282,99

Serie 14 - PN16

Referencia	DN	€/Ud.
66615000012	150	1.770,63
666200016012	200	1.897,45
666250016012	250	2.176,75
666300016012	300	2.507,44
666350016012	350	3.340,59
666400016012	400	3.846,26
666450016012	450	5.514,13
666500016012	500	6.072,78
666600016012	600	9.204,70
666700016012	700	11.683,52
666800016012	800	16.304,84
666900016012	900	23.486,86
666100016012	1000	28.143,76
666110016012	1100	42.522,25

Con eje en acero inoxidable AISI 316 L +10%

Serie 14 - PN25

Referencia	DN	€/Ud.
666150025012	150	2.167,13
666200025012	200	2.321,25
666250025012	250	2.661,53
666300025012	300	3.066,09
666350025012	350	4.085,42
666400025012	400	4.703,47
666450025012	450	6.745,37
666500025012	500	7.427,62
666600025012	600	11.259,45
666700025012	700	19.130,13
666800025012	800	23.238,04
666900025012	900	29.289,95
666100025012	1000	38.285,91
666110025012	1100	CONSULTAR



VÁLVULAS DE COMPUERTA DE CIERRE ELÁSTICO MODELO 3000 PARA GAS

Serie 14 - PN10-16

Referencia	Ø	€/Ud.
666063G10020	63	808,37
666075G10020	75	898,18
666090G10020	90	1.077,83
666110G10020	110	1.257,48
666125G10020	125	1.616,75
666160G10020	160	2.065,85
666200G10020	200	3.592,76
666250G10020	250	4.311,32
666315G10020	315	8.981,92

Con extremos de PE SDR11-SDR17



VÁLVULAS DE RETENCIÓN DE CLAPETA
SERIE 48 - PN 16

Referencia	DN	€/Ud.
666050000028	50	344,00
666060000028	60	429,99
666065000028	65	429,99
666080000028	80	481,60
666100000028	100	584,78
666125000028	125	872,03
666150000028	150	1.289,95
666200000028	200	1.931,51
666250000028	250	3.439,90
666300000028	300	4.299,85
666350000028	350	5.159,83
666400000028	400	7.223,76
666450000028	450	10.319,65
666500000028	500	13.415,55
666600000028	600	19.435,35

Con eje y asiento en acero inoxidable AISI 316 L +30%



VÁLVULAS DE RETENCIÓN DE CLAPETA CON CONTRAPESO

SERIE 48 - PN 16

Referencia	DN	€/Ud.
666050016028	50	412,78
666060016028	60	515,99
666065016028	65	515,99
666080016028	80	584,78
666100016028	100	687,99
666125016028	125	1.031,96
666150016028	150	1.547,96
666200016028	200	2.321,92
666250016028	250	4.127,88
666300016028	300	5.159,83
666350016028	350	6.019,79
666400016028	400	8.599,72
666450016028	450	12.039,60
666500016028	500	14.619,51
666600016028	600	20.639,33

Con eje en acero inoxidable 316 L +30%

También disponible en color rojo para saneamiento y aguas residuales. **PRECIOS CONSULTAR**



FILTRO

PN16

Referencia	DN	€/Ud.
666040000032	40	235,33
666050000032	50	267,67
666060000032	60	362,87
666065000032	65	362,87
666080000032	80	393,41
666100000032	100	571,25
666125000032	125	704,19
666150000032	150	937,71
666200000032	200	1.564,63
666250000032	250	2.319,14
666300000032	300	3.111,34

También disponible en PN10 y PN25



VÁLVULAS DE RETENCIÓN DE BOLA

PN 16

Referencia	Ø x Rh	€/Ud.
666032001630	32-1 ¼"	125,55
666040001630	40-1 ½"	125,55
666050001630	50-2"	151,36

Disponible también en PN10

También disponible en color rojo para saneamiento y aguas residuales. **PRECIOS CONSULTAR**



VÁLVULAS DE RETENCIÓN DE BOLA

PN 16

Referencia	DN	€/Ud.
666040016031	40	180,60
666050016031	50	180,60
666060016031	60	223,58
666065016031	65	223,58
666080016031	80	266,59
666100016031	100	378,40
666125016031	125	567,58
666150016031	150	705,18
666200016031	200	1.152,37
666250016031	250	2.476,73
666300016031	300	3.405,48
666350016031	350	5.331,84
666400016031	400	8.444,91

Disponible también en PN10

También disponible en color rojo para saneamiento y aguas residuales. **PRECIOS CONSULTAR**

HERRAMIENTA PARA EXTRACCIÓN DE BOLA

Referencia	DN	€/Ud.
10763744	32-1 ¼"	215,57
10763744	40-1 ½"	215,57
10763754	50-2"	215,57
10763744	40	215,57
10763754	50	215,57
10763764	60	359,27
10763764	65	359,27
10763784	80	359,27
10763794	100	413,17
10763804	125	413,17
10763814	150	467,06
10763824	200	556,85
10763834	250	682,62
10763844	300	898,18
10763854	350	1.257,48
10763864	400	1.616,75



BOLA DE RECAMBIO

Referencia	DN	€/Ud.
BOLA DE RECAMBIO DE ALUMINIO	32 / 1¼"	64,52
BOLA DE RECAMBIO DE ALUMINIO	40 / 1½"	64,52
BOLA DE RECAMBIO DE ALUMINIO	50 / 2"	64,52
BOLA DE RECAMBIO DE ALUMINIO	40	64,52
BOLA DE RECAMBIO DE ALUMINIO	50	64,52
BOLA DE RECAMBIO DE ALUMINIO	60	69,78
BOLA DE RECAMBIO DE ALUMINIO	65	69,78
BOLA DE RECAMBIO DE ALUMINIO	80	81,97
BOLA DE RECAMBIO DE ALUMINIO	100	123,84
BOLA DE RECAMBIO DE HIERRO	125	176,15
BOLA DE RECAMBIO DE HIERRO	150	211,03
BOLA DE RECAMBIO DE HIERRO	200	385,42
BOLA DE RECAMBIO DE HIERRO	250	776,11
BOLA DE RECAMBIO DE HIERRO	300	1.130,14
BOLA DE RECAMBIO DE HIERRO	350	1.574,89
BOLA DE RECAMBIO DE HIERRO	400	2.799,23



VENTOSAS AUTOMÁTICAS DE DOBLE EFECTO

PN 16

Referencia	DN	€/Ud.
666040065011	40-50-60-65	325,16
666080002111	80	384,42
666100002111	100	384,42
666025002111	1"	282,02
666032002111	1 ¼"	282,02

Referencia	DN	€/Ud.
666040000111	1 ½"	282,02
666200002111	2"	282,02
666212002111	2 ½"	296,40

Opcional con filtro. Consultar.



VENTOSAS AUTOMÁTICAS DE TRIPLE EFECTO SIN VÁLVULA PARA AGUAS LIMPIAS

PN 10

Referencia	DN	€/Ud.
19908610	50	731,12
19908615	60	731,12
19908620	65	731,12
19908630	80	860,46
19908640	100	860,46
19908650	150	2.204,16
19908660	200	3.533,50

PN 16

Referencia	DN	€/Ud.
19908610	50	731,12
19908615	60	731,12
19908620	65	731,12
19908630	80	860,46
19908640	100	860,46
19908650	150	2.204,16
19908661	200	3.533,50



VENTOSAS AUTOMÁTICAS DE TRIPLE EFECTO CON VÁLVULA PARA AGUAS LIMPIAS

PN 10

Referencia	DN	€/Ud.
666050003005	50	1.007,78
666060003005	60	1.007,78
666065003005	65	1.007,78
666080003005	80	1.230,52
666100003005	100	1.230,52
666150003005	150	2.759,25
666200013005	200	4.458,63

PN 16

Referencia	DN	€/Ud.
666050003005	50	1.007,78
666060003005	60	1.007,78
666065003005	65	1.007,78
666080003005	80	1.230,52
666100003005	100	1.230,52
666150003005	150	2.759,25
666200003005	200	4.458,63

PATROL
X-380



Medida	Ref.	U/	n.º	€
¾" BSP	093108	10	A-10	18,95
1" BSP	093109	10	A-10	18,95

Ventosa doble efecto, cierre a baja presión.

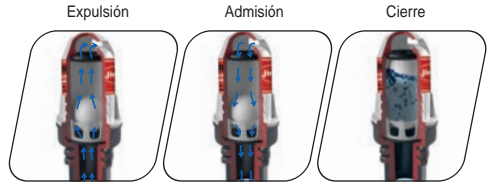

X-380 - Ventosa de Vacío/ Cierre a baja presión.

Expulsión: En el momento de llenado de la red, la ventosa permanece abierta expulsando todo el aire sobrante de la instalación, hasta que la red está llena de agua y la ventosa cierra de manera estanca.

Admisión: Bajo presiones negativas (vacío), la ventosa abre introduciendo aire en la red, evitando de esta forma deterioros en tuberías y accesorios.

Cierre: En el momento en que el agua toma contacto con el flotador, lo empuja hasta su cierre estanco con la junta torica.

X-294



Medida	Ref.	U/	n.º	€
¾" BSP	093067	10	A-10	19,86
1" BSP	093068	10	A-10	19,86
1 ½" BSP	093082	4	A-2	43,56
2" BSP	093083	4	A-2	43,56
1 ½" BSP	193082*	4	A-2	45,74
2" BSP	193083*	4	A-2	45,74

Ventosa doble efecto.

* Con filtro de toma.

X-295



Medida	Ref.	U/	n.º	€
¾" BSP	093071	10	A-10	38,99
1" BSP	093072	10	A-10	38,99
1 ½" BSP	093086	1	A-1	124,10
2" BSP	093087	1	A-1	124,10
1 ½" BSP	193086*	1	A-1	130,50
2" BSP	193087*	1	A-1	130,50

Ventosa triple efecto.

* Con cuna filtro.

Medida	Ref.	U/	n.º	€
1 ½"-2"	093116	10	A-10	6,20

Cuna filtro ventosa.



HIDRANTE DE SUPERFICIE COLUMNA SECA

Referencia	DN	PN	€/Ud.
666045070036	100	2x45-1x70	1.719,94
666070100036	100	2x70-1x100	1.719,94



HIDRANTES DE ACERA

Referencia	DN	Salidas DN	Con Arqueta	€/Ud.
666080070034	80	BARNA 70	SI	649,77
666080070035	80	BARNA 70	NO	489,23
666100100034	100	100	SI	783,53
666100100035	100	100	NO	623,01



BOCA DE RIEGO

Referencia	DN	Salidas DN	€/Ud.
666040065014	40-50-60-65	Rosca 1 1/2" Racord Barcelona	428,08



COLLARÍN DE TOMA PARA PVC Y PE
PN10 - PN16 - PN25

Referencia	Ø x Rh	€/Ud.
666050034004	50 ¾"	30,57
666050100004	50 1"	30,57
666050114004	50 1 ¼"	30,57
666050112004	50 1 ½"	30,57
666063034004	63 ¾"	33,64
666063100004	63 1"	33,64
666063114004	63 1 ¼"	33,64
666063112004	63 1 ½"	33,64
666063200004	63 2"	33,64
666075034004	75 ¾"	38,21
666075100004	75 1"	38,21
666075114004	75 1 ¼"	38,21
666075112004	75 1 ½"	38,21
666075200004	75 2"	38,21
666090034004	90 ¾"	44,32
666090100004	90 1"	44,32
666090114004	90 1 ¼"	44,32
666090112004	90 1 ½"	44,32
666090200004	90 2"	44,32
666090212004	90 2 ½"	53,52
666110034004	110 ¾"	53,52
666110100004	110 1"	53,52
666110114004	110 1 ¼"	53,52
666110112004	110 1 ½"	53,52
666110200004	110 2"	53,52
666110212004	110 2 ½"	64,22
666110300004	110 3"	68,79
666125034004	125 ¾"	82,56
666125100004	125 1"	82,56
666125114004	125 1 ¼"	82,56
666125112004	125 1 ½"	82,56
666125200004	125 2"	82,56
666125212004	125 2 ½"	99,37
666125300004	125 3"	107,03
666140034004	140 ¾"	82,56
666140100004	140 1"	82,56
666140114004	140 1 ¼"	82,56
666140112004	140 1 ½"	82,56
666140200004	140 2"	82,56
666140212004	140 2 ½"	99,37
666140300004	140 3"	107,03
666160034004	160 ¾"	85,61
666160100004	160 1"	85,61

Referencia	Ø x Rh	€/Ud.
666160114004	160 1 ¼"	85,61
666160112004	160 1 ½"	85,61
666160200004	160 2"	85,61
666160212004	160 2 ½"	100,92
666160300004	160 3"	110,08
666180034004	180 ¾"	122,30
666180100004	180 1"	122,30
666180114004	180 1 ¼"	122,30
666180112004	180 1 ½"	122,30
666180200004	180 2"	122,30
666200034004	200 ¾"	122,30
666200100004	200 1"	122,30
666200114004	200 1 ¼"	122,30
666200112004	200 1 ½"	122,30
666200200004	200 2"	122,30
666200212004	200 2 ½"	152,89
666200300004	200 3"	165,13
666225034004	225 ¾"	152,85
666225100004	225 1"	152,85
666225114004	225 1 ¼"	152,85
666225112004	225 1 ½"	152,85
666225200004	225 2"	152,85
666225212004	225 2 ½"	182,43
666225300004	225 3"	182,43
666250034004	250 ¾"	152,85
666250100004	250 1"	152,85
666250114004	250 1 ¼"	152,85
666250112004	250 1 ½"	152,85
666250200004	250 2"	152,85
666250212004	250 2 ½"	198,84
666250300004	250 3"	198,84
666280034004	280 ¾"	177,49
666280100004	280 1"	177,49
666280114004	280 1 ¼"	177,49
666280112004	280 1 ½"	177,49
666280200004	280 2"	177,49
666280212004	280 2 ½"	210,38
666280300004	280 3"	210,38
666315034004	315 ¾"	182,43
666315100004	315 1"	182,43
666315114004	315 1 ¼"	182,43
666315112004	315 1 ½"	182,43
666315200004	315 2"	182,43
666315212004	315 2 ½"	182,43
666315300004	315 3"	216,94
666400034004	400 ¾"	221,87
666400100004	400 1"	221,87
666400114004	400 1 ¼"	221,87
666400112004	400 1 ½"	221,87
666400200004	400 2"	221,87
666400212004	400 2 ½"	262,97
666400300004	400 3"	282,67

**ADAPTADOR DE TOMA EN CARGA****PN 10 - PN 16**

Referencia	Rm x Rh	€/Ud.
666212000000	2" 1/2"	179,64
666234000000	2" 3/4"	179,64
666210000000	2" 1"	179,64
666211400000	2" 1 1/4"	179,64
666211200000	2" 1 1/2"	179,64
666220000000	2" 2"	179,64

**LAMINA DE CORTE**

Referencia	€/Ud.
666LAM000000	89,82



BRIDAS DE UNIÓN DE DOBLE CÁMARA PARA TUBO DE PVC

Referencia	DN/DN Tubo	PN	€/Ud.
666063000000	50-63	10/16	30,97
666050065000	50-60-65/63	10/16	30,97
666065000000	60-65/63	10/16	30,97
666075000000	60-65/75	10/16	32,66
666090000000	80/90	10/16	39,55
666100000000	100/90	10/16	44,72
666110000000	100/110	10/16	44,72
666125000000	125/125	10/16	53,33
666140000000	125/140	10/16	58,46
666160000000	150/160	10/16	80,83
666200000000	200/200	10/16	96,31
666225000000	200/225	10/16	201,25
666250000000	250/250	10/16	180,60
666280000000	250/280	10/16	330,23
666315000000	300/315	10/16	330,23
666400010000	400/400	10	662,18
666400000000	400/400	16	662,18
666500010000	500/500	10	1.023,37
666500000000	500/500	16	1.023,37

También disponible en color rojo para saneamiento y aguas residuales. **PRECIOS CONSULTAR**



También disponible en color rojo para saneamiento y aguas residuales. **PRECIOS CONSULTAR**

BRIDAS DE UNIÓN DE DOBLE CÁMARA CON ANILLO AUTOBLOCANTE PARA PVC Y PE

Referencia	DN/DN Tubo	PN	€/Ud.
666063000003	50/63	10/16	51,60
666065000003	60-65/63	10/16	56,75
666075000003	60-65/75	10/16	61,90
666090000003	80/90	10/16	70,52
666100000003	100/90	10/16	77,40
666110000003	100/110	10/16	77,40
666125000003	125/125	10/16	108,36
666140000003	125/140	10/16	113,50
666160000003	150/160	10/16	144,47
666200000003	200/200	10/16	185,76
666225000003	200/225	10/16	481,60
666250000003	250/250	10/16	423,09
666280000003	250/280	10/16	791,19
666315000003	300/315	10/16	589,93
666400010003	400/400	10	1.147,19
666400000003	400/400	16	1.147,19
666500010003	500/500	10	1.761,22
666500000003	500/500	16	1.761,22

Referencia	DN/DN Tubo	PN	€/Ud.
666063025003	50/63	25	63,64
666065025003	60-65/63	25	70,52
666075025003	60-65/75	25	79,11
666090025003	80/90	25	87,71
666100025003	100/90	25	98,03
666110025003	100/110	25	98,03
666125025003	125/125	25	132,43
666140025003	125/140	25	142,74
666160025003	150/160	25	180,60
666200025003	200/200	25	232,19
666225025003	200/225	25	605,42
666250025003	250/250	25	531,47
666280025003	250/280	25	CONSULTAR
666315025003	300/315	25	741,29
666400025003	400/400	25	1.499,79
666500025003	500/500	25	2.289,25



CINTAS DE SEÑALIZACIÓN

Referencia	Descripción	€/rollo
Rollo: A=15 cm, L=500		
CSA000500015	¡ATENCIÓN! Tubería de Agua Potable	128,75
CSG000500015	Canalización de Gas	128,75
CST000500015	Servicios de Telecomunicaciones	128,75

REDI

Accesorios para saneamiento enterrado PVC

INFRAESTRUCTURA





Accesorios para saneamiento enterrado PVC

Color Gris / Cór Cinza: Ral 7037 • Color Teja / Cór Telha: Ral 8023

CON JUNTA / COM JUNTA FACETADA



45°

Medida	Ref.	U/	U/Pallet	€
110	SN8 030115E	15	120	15,96
125	080125E	10	80	19,48
160	030165E	4	32	43,41
200	0302051	1	20	104,91
250	0302591	1	12	294,39
315	1303091	1	5	707,07
400	o N304091	1	2	870,47
500	*o N305091	1	1	1.592,89
630	*o N306391	1	1	2.833,85

Derivación 45° macho/hembra, **con junta labiada**. Color Teja.
Forquilha 45° macho/fêmea, com o-ring labial. Cór Telha.



45°

Medida	Ref.	U/	U/Pallet	€
110	044115E	12	96	16,52
160	0441641	4	32	51,45
200	1442041	1	20	161,57
315	1443041	1	4	810,07

Derivación 45° hembra/hembra, **con junta labiada**. Color Teja.
Forquilha 45° fêmea/fêmea, com o-ring labial. Cór Telha.



45°

Medida	Ref.	U/	U/Pallet	€
125-110	031925E	10	80	14,00
160-110	031165E	7	56	46,14
160-125	031365E	6	48	52,66
200-110	031355E	4	32	96,15
200-125	031375E	4	32	101,88
200-160	031205E	3	24	104,16
250-110	o 0313391	1	20	287,58
250-125	o D313491	1	16	287,58
250-160	o 0314091	1	20	304,72
250-200	o 0314191	1	14	309,42
315-110	o 1318051	1	10	573,66
315-125	o 1318151	1	9	573,66
315-160	o 0314291	1	12	684,10
315-200	o 0314391	1	10	716,04
315-250	o D314491	1	5	797,93
400-110	o 1314451	1	4	878,47
400-160	o 1316651	1	4	958,71
400-200	o 1317751	1	4	982,96
400-250	o D314691	1	3	1.057,71
400-315	o D314791	1	3	1.057,71
500-110	*o 1315051	1	2	899,35
500-160	*o 1315351	1	2	1.509,36
500-200	*o 1315451	1	2	1.509,36
500-250	*o D314991	1	3	1.743,78
500-315	*o D315091	1	1	1.743,78
500-400	*o D315191	1	1	1.872,26

Derivación 45° macho/hembra, reducida al centro, **con junta labiada**. Color Teja.

Forquilha 45° macho/fêmea, redução ao centro, com o-ring labial. Cór Telha.



45°

Medida	Ref.	U/	U/Pallet	€
160-110	0311741	6	48	57,42
160-125	+ 0311832	6	48	59,15
200-125	+ 0313832	4	32	107,03
200-160	0312151	1	25	111,42
250-160	1444041	1	16	322,15
315-110	1443451	1	10	573,66
315-125	o+ 1443542	1	10	573,66
315-250	* 1444551	1	6	836,39
400-110	*o 1444441	1	5	878,47
400-160	o+ 1446642	1	5	878,47
400-200	*o+ 1447742	1	4	878,47

Derivación 45° hembra/hembra, reducida al centro, **con junta labiada**. Color Teja.

Forquilha 45° fêmea/fêmea, redução ao centro, com o-ring labial. Cór Telha.



87°-30'

Medida	Ref.	U/	U/Pallet	€
110	SN8 034115E	20	160	13,55
125	081125E	12	96	16,45
160	081165E	5	40	40,83
200	081205E	1	30	87,57
250	0342591	1	18	243,39
315	1343091	1	8	579,50
400	*o 1344051	1	2	870,47
500	*o N345091	1	1	1.980,47
630	*o N346391	1	1	2.964,75

Derivación 87° - 30' macho/hembra, con junta labiada. Color Teja.
Forquilha 87° - 30' macho/fêmea, com o-ring labial. Côr Telha.



87°-30'

Medida	Ref.	U/	U/Pallet	€
160	0451641	5	40	42,85
200	1452041	1	28	151,20
315	1453041	1	6	675,74
400	o 1454051	1	2	1.169,21

Derivación 87°-30', hembra/hembra, con junta labiada. Color Teja.
Forquilha 87°-30', fêmea/fêmea, com o-ring labial. Côr Telha.



87°-30'

Medida	Ref.	U/	U/Pallet	€
160-110	0351741	8	64	52,79
200-110	0460141	1	33	138,25
200-160	* 0460641	1	30	139,63
250-125	* 1461241	1	18	287,99
250-160	* 1461641	1	18	323,27
315-125	1464341	1	10	384,84
315-160	1464251	1	10	384,84
315-200	*o 1464451	1	10	392,50
400-110	*o 1465541	1	5	568,65
400-125	*o 1463341	1	9	568,65
400-160	1466641	1	5	663,32
400-200	o*+ 1467741	1	4	637,84
400-250	o*+ 1468842	1	4	722,65
400-315	1469942	1	3	748,98

Derivación 87°-30', hembra/hembra, reducida al centro, con junta labiada. Color Teja.
Forquilha 87°-30', fêmea/fêmea, redução ao centro, com o-ring labial. Côr Telha.



87°-30'

Medida	Ref.	U/	U/Pallet	€
125-110	0357251	12	96	38,36
160-110	035165E	10	80	47,00
160-125	0353651	1	70	48,96
200-110	035015E	4	32	78,56
200-125	035025E	4	32	67,22
200-160	o 035205E	4	32	72,62
250-110	o 0353551	1	20	139,63
250-125	0353451	1	18	153,03
250-160	o 0354051	1	18	233,13
250-200	o 0353851	1	18	255,28
315-110	o 1352251	1	10	384,84
315-125	o 1353351	1	10	384,84
315-160	o 1354451	1	12	373,70
315-200	o 1355551	1	12	384,84
315-250	o D354691	1	6	598,20
400-110	*o 1354151	1	5	568,65
400-125	*o+ 1354252	1	5	568,65
400-160	o 1356651	1	4	597,57
400-200	o 1357751	1	4	625,31
400-250	o 1358851	1	4	663,32
400-315	o 1359951	1	4	681,28
500-110	*o 1355051	1	2	907,38
500-125	*o 1355251	1	2	912,78
500-200	*o 1355451	1	2	1.119,52
500-250	*o D354991	1	3	1.778,55
500-315	*o D355091	1	2	2.238,51
500-400	*o D355191	1	1	2.406,83

Derivación 87°-30', macho/hembra, reducida al centro, con junta labiada. Color Teja.

Forquilha 87°-30', macho/fêmea, redução ao centro, com o-ring labial. Côr Telha.

SN8: Rigidez anular. / Rigidez anular.

o: Producto manipulado. / Produto manipulado.

+ : Color gris. / Côr Cinza.

*: Bajo pedido. / Sob pedido.



87°-30'

Medida	Ref.	U/	U/Pallet	€
250	1402591	1	16	265,04
315	1403091	1	8	642,61

Te macho/hembra 87°-30' con boca de registro, con junta labiada.
Color Teja.

Forquilha macho/fêmea 87°-30' com boca de registro, com o-ring labial.
Côr Telha.



Medida	Ref.	U/	U/Pallet	€
110	061115E	45	360	7,66
125	061125E	30	240	11,16
160	061165E	18	144	24,37
200	061205E	8	64	47,68
250	0612591	1	36	132,62
315	0613091	1	20	212,21
400	0614091	1	12	339,58
500	1615051	1	4	738,26
630	D616391	1	3	2.279,41

Manguito dilatación hembra-hembra, con junta labiada.
Color Teja. SIN tope.

União dilatação fêmea-fêmea, com o-ring labial. Côr Telha.
SEM topo.



Medida	Ref.	U/	U/Pallet	€
110	063115E	45	360	9,60
125	063125E	30	240	12,10
160	063165E	18	144	24,37
200	063205E	8	64	47,68
250	0632591	1	36	132,62
315	0633091	1	20	212,21
400	0634091	1	12	339,58
500	1635051	1	4	738,26

Manguito dilatación hembra-hembra, con junta labiada.
Color Teja. CON tope.

União dilatação fêmea-fêmea, com o-ring labial. Côr Telha.
COM topo.



Ángulo - Medida	Ref.	U/	U/Pallet	€
15° 110 SN8	010115E	40	320	5,43
15° 125	010125E	25	200	9,30
15° 160	010165E	13	104	18,46
15° 200	010205E	8	64	38,64
15° 250	0102591	1	36	103,71
15° 315	0103091	1	18	163,32
15° 400	1104091	1	10	492,54
15° 500 *o	N105091	1	2	841,73
15° 630 *o	N106391	1	1	1.595,58
30° 110 SN8	011115E	40	320	5,02
30° 125	011125E	25	200	9,02
30° 160	011165E	13	104	21,45
30° 200	011205E	1	60	42,85
30° 250	0112591	1	33	114,82
30° 315	0113091	1	18	180,84
30° 400	1114091	1	8	553,22
30° 500 *o	N115091	1	2	1.102,61
30° 630 *o	N116391	1	1	1.595,58
45° 110 SN8	012115E	35	280	6,97
45° 125	070125E	23	184	8,36
45° 160	070165E	10	80	22,79
45° 200	070205E	5	40	53,22
45° 250	0122591	1	27	141,42
45° 315	0123091	1	14	204,71
45° 400	1124091	1	7	611,93
45° 500	1125091	1	4	914,46
45° 630 *o	N126391	1	1	1.595,58
67°-30' 110 SN8	013115E	30	240	6,77
67°-30' 125	013125E	20	160	11,20
67°-30' 160	013165E	10	80	25,86
67°-30' 200	013205E	5	40	56,43
87°-30' 110 SN8	071115E	25	200	8,42
87°-30' 125	071125E	20	160	13,94
87°-30' 160	071165E	10	80	24,95
87°-30' 200	071205E	1	40	56,75
87°-30' 250	0142591	1	20	177,32
87°-30' 315	0143091	1	10	294,98
87°-30' 400	1144091	1	6	817,83
87°-30' 500 *o	N145091	1	2	1.831,01
87°-30' 630 *o	N146391	1	1	2.041,96

Codo macho/hembra, con junta labiada. Color Teja
Curva macho/fêmea, com o-ring labial. Côr Telha.



Ángulo - Medida	Ref.	U/	U/Pallet	€
45° 110	023115E	30	240	18,77
45° 125 +	0231242	20	160	21,40
45° 160	0231641	10	80	32,22
45° 200	0232041	5	40	63,84
45° 250	1232541	1	27	190,39
45° 315	1233041	1	12	275,64
45° 400	1234051	1	6	698,52
87°-30' 110	024135E	25	200	19,17
87°-30' 125 +	0241242	18	144	21,40
87°-30' 160	0241641	8	64	35,79
87°-30' 200	0242141	4	32	76,38
87°-30' 250	1242541	1	20	238,71
87°-30' 315	1243041	1	10	397,08
87°-30' 400	1244051	1	5	951,58

Codo hembra/hembra, con junta labiada. Color Teja
 Curva fêmea/fêmea, com o-ring labial. Cór Telha.



Medida H / M	Ref.	U/	U/Pallet	€
A 110-125	051325E	35	280	8,12
A 110-160	051165E	30	240	12,87
B 110-200 o	1533551	15	120	59,50
B 110-250	0534151	10	80	90,96
A 125-160	051365E	30	240	12,87
A 125-200	051205E	15	120	32,18
B 125-250	0534251	10	80	168,22
A 160-200	051405E	15	120	44,51
A 160-250	0514651	1	85	56,13
B 160-315	0534851	5	40	63,32
A 200-250	051255E	5	60	74,29
A 200-315	051335E	4	32	103,56
B 200-400 o	1536551	1	26	262,45
A 250-315	0513091	1	32	119,80
B 250-400	1537091	1	24	358,91
A 315-400	0519291	1	18	272,47
C 400-500 o	D519491	1	4	707,25

Ampliación excéntrica hembra-macho, con junta labiada. Color Teja.
 Ampliação excêntrica fêmez-macho, com o-ring labial. Cór Telha.
 H = Hembra-fêmea - M = Macho-macho.

SN8 : Rigidez anular. / Rigidez anular.

* : Consultar plazo de entrega. / Consultar prazo de entrega.

o : Producto manipulado. / Produto manipulado.

+ : Color gris. / Cór Cinza.



Medida	Ref.	U/	U/Pallet	€
110	066110E	150	1200	4,21
125	066120E	100	800	5,34
160	066160E	55	440	11,82
200	066200E	25	200	19,45
250	0662501	1	114	61,78
315	0663001	1	67	115,11
400	06640M1	1	50	175,59
500	D665001	1	18	597,70

Tapón macho ciego para encolar. Color Teja.
 Tampão macho cego. Cór Telha.



Medida	Ref.	U/	U/Pallet	€
110	0651101	70	560	8,97
125	0651201	50	400	11,23
160	1651601	30	240	19,13
200	1652001	15	120	32,18
250	1652501	10	100	83,37
315	1653001	5	50	122,46

Tapón macho con registro, para encolar. Color Teja.
 Tampão macho com registro, para colar. Cór Telha.



Medida	Ref.	U/	U/Pallet	€
110	06613F1	30	1560	2,63
125	06615F1	20	1040	2,82
160	06617F1	30	720	9,72
200	06621F1	60	480	12,60
250	06628F1	30	240	27,40
315	06634F1	15	120	45,67
400	06640F1	1	50	140,53

Tapón hembra para encolar. Color Teja.
 Tampão fêmea. Cór Telha.



S-197

Medida	Ref.	U/	n.º	€
250	027004	12	A-61	40,98
315	027028	4	A-4	74,55

Tapón base, para encolar. Color Teja.
 Tampão base, para colar. Cór Telha.



90°

Medida	Ref.	U/	U/Pallet	€
200-160	0434351	10	80	35,34
250-160	1424251	8	64	46,04
315-160	142525E	8	64	81,85

Toma injerto 90°, con junta labiada. Color Teja.

Forquilha 90°, com o-ring labial. Cór Telha.



45°

Medida	Ref.	U/	U/Pallet	€
160-125	0438091	15	120	29,46
200-125	0438291	10	80	32,95
200-160	0438491	10	60	42,55
250-125	0438691	10	70	43,58
250-160	0438891	6	48	56,67
315-125	1439091	5	40	69,50
315-160	0439491	5	30	84,21
400-125	1439191	5	40	83,66
400-160	1439591	3	24	96,82
400-200	D434291	1	1	94,00
500-125	1439291	5	100	94,74
500-160	1439691	3	24	136,69

Toma injerto 45°, con junta labiada. Color Teja.

Forquilha 45°, com o-ring labial. Cór Telha.



Medida	Ref.	U/	U/Pallet	€
136-110	0621191	30	240	26,49
160-125	0621291	18	144	39,94
190-160	0621691	10	80	63,05
242-200	0622091	1	60	144,75

Enlace mixto gres-PVC. Color Teja (unión a PVC, Macho Encolar).

União mista granito-PVC. Cór Telha (união PVC, Macho colar).



Medida	Ref.	U/	U/Pallet	€
110	0641191	10	520	19,19
125	0641291	18	432	20,70
160	0641642	12	168	36,60
200	0642042	12	96	70,72

Manguito pasamuros, Superficie granulada, para mejor agarre al cemento.

União passamuros. Superfície granulada, para melhor aderência do cimento.



Tubería de PVC-U presión



0802

Tubería PVC-U

INDUSTRIA



Más información



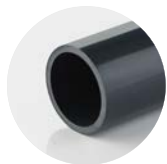

INDUSTRIA

Tubería de PVC-U presión

Tubería de PVC-U presión



UN EN 1452-2
PN 6 - 10 - 12,5 - 16 - 20
ø 16 ÷ 500 mm



NF EN 1452
PN 6 - 10 - 16 - 25
ø 16 ÷ 315 mm



DN-8061 - 62
Reihe 4, Reihe 5
PN 10 - 16



CARACTERÍSTICAS PRINCIPALES DE LAS TUBERÍAS DE PVC-U

Gama

PN 6 : desde d.63 hasta d400 mm
PN 10 : desde d 63 hasta d 315 mm
PN16 : desde d 20 hasta d.225 mm

La tubería cumple con la norma EN ISO 1452 para el transporte de fluidos bajo presión (agua potable, riego y aguas residuales). Tiene la marca de calidad IIP conforme a D.M. 174 DD. (agua para consumo humano), y según norma EN 1622, análisis de agua, determinación del umbral de olor (TON) y sabor (TFN).

Requisitos higiénicos

Los tubos Lareter U-PVC para conductos de presión cumplen requisitos higiénicos según el "Ministerio de Salud italiano" D.M.21.03.1973 y D.M. 174/2004.

Francia: certificación A.C.S.

(Atestación de Conformité Sanitaire)

Gran Bretaña: aprobado por WRAS (Water Regulations Advisory Scheme) producto.

Alemania: potabilidad publicada por Hygiene-Institut en nombre de DVGW

PN6

Ø	Ref.	Espesor	Longitud (m)	Tubos/pallet	m (pallet completo)	€
63	PIPEV33063	2	5	123	615	6,82
75	PIPEV33075	2,2	5	87	435	9,47
90	PIPEV33090	2,8	5	96	480	13,14
110	PIPEV41110	2,7	5	57	285	15,63
125	PIPEV41125	3,1	5	51	255	20,47
140	PIPEV41140	3,5	5	45	225	25,61
160	PIPEV41160	4	5	33	165	33,17
200	PIPEV41200	4,9	5	20	100	50,86
225	PIPEV41225	5,5	5	18	90	64,29
250	PIPEV41250	6,2	5	12	60	80,64
280	PIPEV41280	6,9	5	11	55	100,16
315	PIPEV41315	7,7	5	9	45	126,06
400	PIPEV41400	9,8	5	5	25	211,98

PN10

63	PIPEV21063	3	5	123	615	9,26
75	PIPEV21075	3,6	5	87	435	12,97
90	PIPEV21090	4,3	5	96	480	18,65
110	PIPEV26110	4,2	5	57	285	22,53
125	PIPEV26125	4,8	5	51	255	29,00
140	PIPEV26140	5,4	5	45	225	37,09
160	PIPEV26160	6,2	5	33	165	48,24
180	PIPEV26180	6,9	5	28	140	64,47
200	PIPEV26200	7,7	5	20	100	74,91
225	PIPEV26225	8,6	5	18	90	94,07
250	PIPEV26250	9,6	5	12	60	116,49
280	PIPEV26280	10,7	5	11	55	145,05
315	PIPEV26315	12,1	5	9	45	185,12

PN16

20	PIPEV13020	1,5	5	1166	5830	2,42
25	PIPEV13025	1,9	5	757	3785	3,74
32	PIPEV13032	2,4	5	449	2245	4,30
40	PIPEV13040	3	5	275	1375	5,60
50	PIPEV13050	3,7	5	194	970	8,64
63	PIPEV13063	4,7	5	123	615	13,74
75	PIPEV13075	5,6	5	87	435	19,44
90	PIPEV13090	6,7	5	96	480	27,87
110	PIPEV17110	6,6	5	57	285	34,20
125	PIPEV17125	7,4	5	51	255	43,59
140	PIPEV17140	8,3	5	45	225	55,30
160	PIPEV17160	9,5	5	33	165	72,12
180	PIPEV17180	10,7	5	28	140	91,18
200	PIPEV17200	11,9	5	20	100	112,48
225	PIPEV17225	13,4	5	20	100	142,59

Tubería PVC-U extremo plano.

Accesorios encolados, mixtos y roscados

Bridas y adaptadores

Uniones 3 piezas

Soportes y abrazaderas

Adhesivos y disolventes



0801

Accesorios de PVC-U presión

INDUSTRIA



Roscas

Perfectas, bien inyectadas y con exactitud milimétrica, ayudan a una perfecta unión suave y fiable con profesionalidad y calidad.



Nervios de tope

Permiten que el tubo sólo penetre hasta el tope.
El pegamento sobrante en su interior se escurre por dentro de la pieza sin cerrar el diámetro interior.

Lineas cada 45°

Ayudan en el montaje para encarar perfectamente los codos y las tes. Con ellas podemos hacer premontajes exactos fuera del lugar donde finalmente se va a colocar, cuando el acceso es complicado.

PVC-U

Packs

Material embolsado hasta diámetro 63 mm. Permite tener las piezas limpias y ordenadas en todo momento. Facilita el contar los stocks así como los inventarios.

Bocas achaflanadas

Ayudan que el tubo entre más fácilmente.
El pegamento sobrante se queda depositado en la zona, cerrando y sellando la unión aún con poco pegamento.



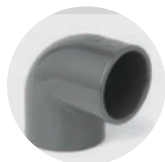

INDUSTRIA

Accesorios de PVC-U presión

Codos



GIV

d	Ref.	PN	Pack	U/	€
12	GIV012	16	10	1.000	1,10
16	GIV016 ●	16	10	500	0,57
20	GIV020 ●	16	10	260	0,57
25	GIV025 ●	16	10	150	0,68
32	GIV032 ●	16	10	120	1,05
40	GIV040 ●	16	10	80	1,49
50	GIV050 ●	16	-	60	2,19
63	GIV063 ●	16	-	50	3,29
75	GIV075 ●	16	-	16	6,17
90	GIV090 ●	16	-	20	10,41
110	GIV110 ●	16	-	10	19,35
125	GIV125 ●	16	-	6	27,86
140	GIV140 ●	16	-	5	47,67
160	GIV160 ●	16	-	4	55,60
180*A)	GIV180 ●	10	-	4	81,92
200*A)	GIV200 ●	16	-	2	87,20
225*A)	GIV225 ●	16	-	2	126,90
250	GIV250 ●	10	-	1	304,28
280	GIV280 ●	10	-	1	566,70
315	GIV315 ●	10	-	1	532,44
400*	GIV400 ●	5	-	1	1.096,35
500*	SIV500				Sólo se fabrica en curva

Codo 90° encolar.
H-H encolar.

A) Factor de seguridad reducido



GIMV

d x Rh	Ref.	PN	Pack	U/	€
16 x 3/8"	GIMV016038	16	10	500	2,14
20 x 1/2"	GIMV020012	16	10	260	2,31
25 x 3/4"	GIMV025034	16	10	150	2,72
32 x 1"	GIMV032100	16	10	80	3,45
40 x 1 1/4"	GIMV040114	16	10	40	4,45
50 x 1 1/2"	GIMV050112	16	10	30	6,35
63 x 2"	GIMV063200	16	5	45	8,39

Codo 90° mixto reforzado inox.
H-H encolar-rosacar.



GFV

Rh	Ref.	PN	Pack	U/	€
3/8"	GFV038	16	10	400	1,34
1/2"	GFV012	16	10	260	1,34
3/4"	GFV034	16	10	150	1,57
1"	GFV100	16	10	150	2,12
1 1/4"	GFV114	16	10	40	3,03
1 1/2"	GFV112	16	10	40	4,29
2"	GFV200 ●	16	-	50	5,94
2 1/2"	GFV212	16	-	16	16,14
3"	GFV300	16	-	9	23,91
4"	GFV400	16	-	10	39,28

Codo 90° roscado.
H-H rosacar.

















GIFV

d x Rh	Ref.	PN	Pack	U/	€
16 x 3/8"	GIFV016038	16	10	400	1,12
20 x 1/2"	GIFV020012 ●	16	10	260	1,15
25 x 3/4"	GIFV025034 ●	16	10	150	1,34
32 x 1"	GIFV032100 ●	16	10	120	1,77
40 x 1 1/4"	GIFV040114 ●	16	10	40	2,33
50 x 1 1/2"	GIFV050112 ●	16	10	40	3,45
63 x 2"	GIFV063200 ●	16	-	50	4,89
75 x 2 1/2"	GIFV075212 ●	16	-	16	15,09
90 x 3"	GIFV090300 ●	16	-	9	22,65
110 x 4"	GIFV110400 ●	16	-	10	34,89

Codo 90° mixto.
H-H encolar-rosacar.

**HIV**

d	Ref.	PN	Pack	U/ 	€
12	HIV012	16	10	800	1,86
16	HIV016 	16	250	1.000	0,75
20	HIV020 	16	10	360	0,75
25	HIV025 	16	10	200	0,99
32	HIV032 	16	10	100	1,34
40	HIV040 	16	10	50	1,77
50	HIV050 	16	-	40	2,41
63	HIV063 	16	-	30	3,45
75	HIV075 	16	-	12	6,85
90	HIV090 	16	-	6	10,17
110	HIV110 	16	-	6	17,19
125	HIV125 	16	-	10	24,98
140	HIV140	16	-	6	40,25
160	HIV160 	16	-	4	49,17
180*	HIV180	10	-	1	153,75
200	HIV200 	10	-	2	72,84
225	HIV225	10	-	2	143,61
250	HIV250	10	-	1	249,01
280	HIV280	10	-	1	494,57
315	HIV315	10	-	1	469,93
400*	HIV400	5	-	1	920,43

Codo 45° encolar.

H-H encolar.



**HFV**

Rh	Ref.	PN	Pack	U/ 	€
1/2"	HFV012	16	10	300	1,62
3/4"	HFV034	16	10	200	1,89
1"	HFV100	16	10	120	2,46
1 1/4"	HFV114	16	5	60	3,11
1 1/2"	HFV112	16	5	30	4,73
2"	HFV200	16	-	30	6,72
2 1/2"	HFV212	16	-	12	24,25
3"	HFV300	16	-	6	32,07

Codo 45° roscado.

H-H roscar.

**SIV**

d	Ref.	PN	Pack	U/ 	€
20	SIV020	16	5	140	1,83
25	SIV025	16	5	80	2,27
32	SIV032	16	5	45	3,27
40	SIV040 	16	-	20	4,31
50	SIV050	16	-	40	6,54
63	SIV063	16	-	24	10,54
75	SIV075	16	-	15	18,81
90	SIV090 	16	-	8	41,82
110	SIV110	16	-	5	74,51
160 A)	SIV160	16	-	4	178,35
180*	SIV180	4	-	1	371,13
200*	SIV200	4	-	1	388,96
225*A)	SIV225	4	-	1	426,33
250*	SIV250	4	-	1	455,37
280*	SIV280	4	-	1	610,33
315*	SIV315	4	-	1	939,71
355*	SIV355	4	-	1	1.136,05
400*	SIV400	4	-	1	1.278,27
500*	SIV500	4	-	1	4.486,06

Curva a 90° encolar.

H-H encolar. R=2d

A) Factor de seguridad reducido

**SIHV***

d	Ref.	PN	U/ 	€
315	SIHV315	4	1	1.097,57
355	SIHV355	4	1	1.393,21
400	SIHV400	4	1	1.685,95
500	SIHV500	4	1	5.308,65

Curva a 45° encolar.

H-H encolar.

**XIV**

d	Ref.	PN	Pack	U/	€
25	XIV025	16	10	80	1,89
32	XIV032	16	10	50	2,72
40	XIV040	16	10	40	4,45
50	XIV050	16	10	20	5,99
63	XIV063	16	-	12	8,50

Cruz 90° encolar.

H-H-H encolar.

**YIV**

d	Ref.	PN	U/	€
20	YIV020	16	200	3,29
25	YIV025	16	100	3,81
32	YIV032	16	60	4,29
40	YIV040	16	50	5,83
50	YIV050	16	20	6,12
63	YIV063	16	15	8,73
75*	YIV075	10	12	40,20
90*	YIV090	10	12	60,15
110*	YIV110	10	8	123,24
160*	YIV160	4	1	192,55

Te a 45° encolar.

H-H-H encolar.

**TIV**

d	Ref.	PN	Pack	U/	€
12	TIV012	16	10	500	1,31
16	TIV016	16	10	300	0,68
20	TIV020	16	10	200	0,68
25	TIV025	16	10	100	0,89
32	TIV032	16	10	100	1,29
40	TIV040	16	10	60	2,09
50	TIV050	16	5	60	3,01
63	TIV063	16	-	30	4,29
75	TIV075	16	-	22	8,97
90	TIV090	16	-	12	16,47
110	TIV110	16	-	8	24,11
125	TIV125	16	-	6	39,51
140	TIV140	16	-	6	60,03
160	TIV160	16	-	5	70,90
180*	TIV180	10	-	3	98,26
200 A)	TIV200	10	-	2	113,64
225 A)	TIV225	10	-	1	157,87
250	TIV250	10	-	1	348,63
280	TIV280	10	-	1	698,47
315	TIV315	10	-	1	629,29
400*	TIV400	4	-	1	1.557,86
500*	TIV500	4	-	1	4.736,23

Te a 90° encolar.

H-H-H encolar.

**TIFV**

d x Rh	Ref.	PN	Pack	U/	€
16 x 3/8"	TIFV016038	16	10	300	1,36
20 x 1/2"	TIFV020012	16	10	180	1,47
25 x 3/4"	TIFV025034	16	10	100	1,65
32 x 1/2"	TIFV032012	16	10	100	2,12
32 x 1"	TIFV032100	16	10	80	2,09
40 x 1 1/4"	TIFV040114	16	10	60	3,40
50 x 1/2"	TIFV050012	16	5	40	4,87
50 x 1 1/2"	TIFV050112	16	5	60	4,65
63 x 1/2"	TIFV063012	16	-	45	7,56
63 x 2"	TIFV063200	16	-	35	7,59
75 x 2 1/2"	TIFV075212	16	-	12	17,42
90 x 3"	TIFV090300	16	-	12	26,10
110 x 4"	TIFV110400	16	-	8	43,21

Te a 90° mixta.

H-H-H encolar-rosocar.



TIMV

d x Rh	Ref.	PN	Pack	U/	€
16 x 3/8"	TIMV016038	16	10	180	2,36
20 x 1/2"	TIMV020012	16	10	180	2,64
25 x 3/4"	TIMV025034	16	10	100	3,03
32 x 1"	TIMV032100	16	10	60	3,79
40 x 1 1/4"	TIMV040114	16	10	30	5,44
50 x 1 1/2"	TIMV050112	16	5	20	7,56
63 x 2"	TIMV063200	16	-	10	10,99

Te a 90° mixta reforzada inox.
H-H-H encolar-rosocar.



TFV

Rh	Ref.	PN	Pack	U/	€
3/8"	TFV038	16	10	300	1,75
1/2"	TFV012	16	10	180	2,09
3/4"	TFV034	16	10	90	2,27
1"	TFV100	16	10	80	2,83
1 1/4"	TFV114	16	10	60	4,45
1 1/2"	TFV112	16	5	60	6,20
2"	TFV200	16	-	30	9,88
2 1/2"	TFV212	16	-	12	20,08
3"	TFV300	16	-	12	26,62
4"	TFV400	16	-	8	48,73

Te a 90° roscada.
H-H-H rosocar.



TRIV

d x Rh	Ref.	PN	Pack	U/	€
25 x 20	TRIV025020	16	10	120	1,12
32 x 20	TRIV032020	16	10	100	1,54
32 x 25	TRIV032025	16	10	90	1,54
40 x 20	TRIV040020	16	10	60	2,64
40 x 25	TRIV040025	16	10	60	2,64
40 x 32	TRIV040032	16	10	60	2,64
50 x 20	TRIV050020	16	5	40	3,43
50 x 25	TRIV050025	16	5	70	3,43
50 x 32	TRIV050032	16	5	60	3,43
50 x 40	TRIV050040	16	5	30	3,43
63 x 25	TRIV063025	16	-	45	5,70
63 x 32	TRIV063032	16	-	45	5,70
63 x 40	TRIV063040	16	-	45	5,70
63 x 50	TRIV063050	16	-	40	5,70
75 x 32	TRIV075032	16	-	18	9,68
75 x 40	TRIV075040	16	-	16	9,68
75 x 50	TRIV075050	16	-	13	9,68
75 x 63	TRIV075063	16	-	12	9,68
90 x 40	TRIV090040	16	-	15	17,13
90 x 50	TRIV090050	16	-	15	17,13
90 x 63	TRIV090063	16	-	12	17,13
90 x 75	TRIV090075	16	-	12	17,13

Te a 90° reducida encolar.
H-H-H encolar.

d x Rh	Ref.	PN	Pack	U/	€
110 x 50	TRIV110050	16	-	10	24,53
110 x 63	TRIV110063	16	-	8	24,53
110 x 75	TRIV110075	16	-	8	24,53
110 x 90	TRIV110090	16	-	8	24,53
125 x 50*	TRIV125050	16	-	1	82,72
125 x 63*	TRIV125063	16	-	1	82,72
125 x 75*	TRIV125075	16	-	1	82,72
125 x 90*	TRIV125090	16	-	1	82,72
125 x 110*	TRIV125110	16	-	1	82,72
160 x 110	TRIV160110	16	-	3	72,34
200 x 90*	TRIV200090	10	-	1	238,16
200 x 110*	TRIV200110	10	-	1	238,16
200 x 160*	TRIV200160	10	-	1	238,16
250 x 110*	TRIV250110	10	-	1	394,29
250 x 160*	TRIV250160	10	-	1	394,29
250 x 200*	TRIV250200	10	-	1	394,29
280 x 225*	TRIV280225	10	-	1	597,57
315 x 200*	TRIV315200	8	-	1	733,09
315 x 250*	TRIV315250	8	-	1	733,09
400 x 110*	TRIV400110	5	-	1	1.053,79
400 x 315*	TRIV400315	4	-	1	1.557,86
400 x 355*	TRIV400355	4	-	1	1.557,86



MIV

d	Ref.	PN	Pack	U/	€
12	MIV012	16	10	1.000	1,10
16	MIV016	16	10	600	0,65
20	MIV020	16	10	360	0,63
25	MIV025	16	10	270	0,75
32	MIV032	16	10	150	0,89
40	MIV040	16	10	80	1,34
50	MIV050	16	10	40	1,72
63	MIV063	16	-	40	2,54
75	MIV075	16	-	24	5,23
90	MIV090	16	-	28	6,75
110	MIV110	16	-	24	11,17
125	MIV125	16	-	14	17,19
140	MIV140	16	-	8	25,42
160	MIV160	16	-	6	34,39
180*	MIV180	10	-	1	112,25
200 A)	MIV200	16	-	6	51,45
225 A)	MIV225	16	-	2	84,01
250	MIV250	10	-	2	171,15
280	MIV280	10	-	2	277,49
315	MIV315	10	-	1	239,97
355*	MIV355	5	-	1	370,29
400*	MIV400	5	-	1	411,66
500*	MIV500	4	-	1	520,72

Manguito encolar.

H-H encolar.



MIMV

d x Rh	Ref.	PN	Pack	U/	€
16 x 3/8"	MIMV016038	16	10	600	1,91
20 x 1/2"	MIMV020012	16	10	400	2,07
25 x 3/4"	MIMV025034	16	10	240	2,38
32 x 1"	MIMV032100	16	10	120	2,77
40 x 1 1/4"	MIMV040114	16	10	80	3,51
50 x 1 1/2"	MIMV050112	16	10	40	4,58
63 x 2"	MIMV063200	16	5	25	6,07

Manguito mixto reforzado inox.

H-H encolar-rosocar.



MIFV

d x Rh	Ref.	PN	Pack	U/	€
16 x 3/8"	MIFV016038	16	10	600	1,15
20 x 1/2"	MIFV020012	16	10	300	1,15
25 x 3/4"	MIFV025034	16	10	200	1,34
32 x 1"	MIFV032100	16	10	100	1,47
40 x 1 1/4"	MIFV040114	16	10	80	1,94
50 x 1 1/2"	MIFV050112	16	10	50	2,51
63 x 2"	MIFV063200	16	-	25	3,58
75 x 2 1/2**	1RMA375H00	16	-	75	15,07
90 x 3**	1RMA390I00	16	-	40	16,66
110 x 4**	1RMA311L00	16	-	25	37,91

Manguito mixto.

H-H encolar-rosocar.



MFV

Rh	Ref.	PN	Pack	U/	€
3/8"	MFV038	16	10	600	1,39
1/2"	MFV012	16	10	300	1,36
3/4"	MFV034	16	10	240	1,59
1"	MFV100	16	10	100	1,94
1 1/4"	MFV114	16	10	80	2,51
1 1/2"	MFV112	16	10	40	3,40
2"	MFV200	16	-	25	4,55
2 1/2"	MFV212	16	-	20	10,99
3"	MFV300	16	-	8	15,45
4"	MFV400	16	-	10	24,03

Manguito roscado.

H-H roscar.



DIMV

dm x dh x Rh	Ref.	PN	Pack	U/	€
20 x 16 x 3/8"	DIMV20016038	16	10	500	3,24
20 x 16 x 1/2"	DIMV20016012	16	10	250	4,29
25 x 20 x 1/2"	DIMV25020012	16	10	300	4,29
25 x 20 x 3/4"	DIMV25020034	16	10	100	5,07
32 x 25 x 3/4"	DIMV32025034	16	10	160	5,13
32 x 25 x 1"	DIMV32025100	16	10	120	5,39
40 x 32 x 1"	DIMV40032100	16	10	100	5,42
40 x 32 x 1 1/4"	DIMV40032114	16	10	40	9,60
50 x 40 x 1 1/4"	DIMV50040114	16	10	40	9,60
50 x 40 x 1 1/2"	DIMV50040112	16	5	30	10,83
63 x 50 x 1 1/2"	DIMV63050112	16	5	30	10,83
63 x 50 x 2"	DIMV63050200	16	5	30	14,73
75 x 63 x 2"	DIMV75063200	16	-	45	14,73

Doble adaptador mixto M/H-H reforzado inox.

M-H encolar - H roscar.

dm = diám.macho

dh = diám.hembra

Rh = diám.hembra

**DIFV**

dm x dh x Rh	Ref.	PN	Pack	U/ 	€
20 x 16 x 3/8"	DIFV20016038	16	10	500	1,23
20 x 16 x 1/2"	DIFV20016012	16	10	400	1,23
25 x 20 x 1/2"	DIFV25020012	16	10	300	1,47
25 x 20 x 3/4"	DIFV25020034	16	10	200	1,47
32 x 25 x 3/4"	DIFV32025034	16	10	130	1,94
32 x 25 x 1"	DIFV32025100	16	10	120	1,94
40 x 32 x 1"	DIFV40032100	16	10	100	2,51
40 x 32 x 1 1/4"	DIFV40032114	16	10	80	2,51
50 x 40 x 1 1/4"	DIFV50040114	16	10	60	3,56
50 x 40 x 1 1/2"	DIFV50040112	16	10	40	3,56
63 x 50 x 1 1/2"	DIFV63050112	16	-	30	5,33
63 x 50 x 2"	DIFV63050200	16	-	24	5,33
75 x 63 x 2"	DIFV75063200	16	-	45	7,48
75 x 63 x 2 1/2"	DIFV75063212	16	-	24	7,48
90 x 75 x 2 1/2"	DIFV90075212	16	-	20	13,29
90 x 75 x 3"	DIFV90075300	16	-	8	13,29
110 x 90 x 3"	DIFV11090300	16	-	6	18,15
110 x 90 x 4"	DIFV11090400	16	-	5	18,15
125 x 110 x 4"	DIFV12110400	16	-	6	33,76

Doble adaptador mixto M/H-H

dm = diám.macho
dh = diám.hembra
Rh = diám.hembra

M-H encolar - H rosacar.

**QPV PLANO**
QRV ESTRIADO

d	Ref.	PN	Pack	U/ 	€
20 +	QPV020	16	10	500	1,20
25 +	QPV025	16	10	340	1,44
32 +	QPV032	16	10	200	1,54
40	QPV040	16	10	110	1,99
50	QPV050	16	10	80	2,49
63	QPV063	16	-	48	3,03
75	QPV075	16	-	20	6,57
90	QPV090	16	-	48	6,27
110	QPV110	16	-	32	7,84
125	QPV125	16	-	7	10,35
140	QPV140	16	-	8	26,25
160	QPV160	16	-	10	19,09
180*	QPV180	16	-	1	73,47
200 A)	QPV200	16	-	6	34,91
225 -- A)	QRV225	16	-	6	58,06
250 -- A)	QRV250	10	-	6	93,27
280* --	QRV280	10	-	4	154,72
315 --	QRV315	10	-	3	144,89
355*+	QPV355	5	-	1	253,43
400*	QRV400	5	-	1	304,17
500*+	QPV500	4	-	1	376,75

Manguito portabridas encolar. +Sólo QPV -- Sólo QRV
H encolar (junta no incluida). A) Factor de seguridad reducido.
Código portabridas plano, para estriado cambiar QPV por QRV



FDV

d	Ref.	DN	T PN	U/ 	€
25	FDV025	20	10	80	5,42
32	FDV032	25	10	48	6,51
40	FDV040	32	10	24	8,50
50	FDV050	40	10	20	9,97
63	FDV063	50	10	14	12,39
75	FDV075	65	10	12	13,03
90	FDV090	75	10	12	15,07
110	FDV110	90	10	6	18,41

Brida con manguito encolar.

T = Taladros

H encolar (junta no incluida).



QPV FK/FE

d	Ref.	DN	PN	€
125 (2)	QPV125FKE	125	16	43,02
200 (3)	QPV200FKE	200	16	108,17

Portabridas especial para válvula de mariposa FE/FK. (2) Convierte la válvula de mariposa de 140 en 125. Usar con brida ODV 140 PVC-U.

Para rebajar el diámetro. (3) Convierte la válvula de mariposa de 225 en 200. Usar con brida ODV 225 PVC-U.



ODB

d	Ref.	DN	€
20	ODB020	15	8,85
25	ODB025	20	9,72
32	ODB032	25	12,51
40	ODB040	32	15,18
50	ODB050	40	17,75
63	ODB063	50	22,08
75	ODB075	65	24,40
90	ODB090	80	29,06
125*	ODB125	100	35,07
140	ODBD140DN125	125	55,06
180**	ODB180	150	61,24
200	ODB200	200	80,21
225	ODBD225DN200	200	113,15
280	ODBD280DN250	250	117,15
315	ODBD315DN300	300	171,56

Brida loca PP negro con alma de acero.

EN ISO/DIN - PN 10 / 16 hasta PN 150 - PN 10 DN 200

* Para QPV 110, QRV 110. ** Para QPV 160, QRV 160.

Ver descuentos aplicables según "Familia PP"



ODV

d	Ref.	T PN	Pack	U/ 	€
20	ODV020	10	-	250	3,14
25	ODV025	10	-	200	3,58
32	ODV032	10	-	120	4,00
40	ODV040	10	-	60	4,63
50	ODV050	10	-	65	6,76
63	ODV063	10	2	30	7,30
75	ODV075	10	2	16	7,43
90	ODV090	10	2	24	7,93
110	ODV110	10	2	20	10,75
125	ODV125	10	-	16	15,45
140	ODV140	10	-	16	17,57
160	ODV160	10	-	18	21,24
180*	ODV180	10	-	-	67,89
200	ODV200	10	-	9	25,63
225	ODV225	10	-	10	29,16
250	ODV250	10	-	11	83,30
280	ODV280	10	-	12	121,65
315	ODV315	10	-	8	126,80
355*	ODV355	4	-	1	204,13
400*	ODV400	4	-	1	219,69
500*	ODV500	6	-	1	329,38
500*	ODV510	10	-	1	363,69

Brida loca PVC-U para manguito portabridas. T = Taladros



FCV

d	Ref.	T PN	Pack	U/ 	€
25	FCV025	10	2	40	5,18
32	FCV032	10	2	60	6,91
40	FCV040	10	2	50	9,00
50	FCV050	10	-	30	10,99
63	FCV063 ●	10	-	30	13,53
75	FCV075	10	2	26	17,76
90	FCV090 ●	10	2	24	20,48
110	FCV110 ●	10	2	18	26,91
140*	FCV140	10	-	1	57,96
160*	FCV160	10	-	1	84,69
180*	FCV180	10	-	1	108,12
200*	FCV200	10	-	1	107,00
225*	FCV225	10	-	1	107,00
250*	FCV250	8	-	1	217,94
280*	FCV280	8	-	1	217,94
315*	FCV315	6	-	1	434,00

Brida Ciega.

T = Taladros



LIFV

d x Rm x Rh	Ref.	PN	Junta	Pack	U/ 	€
16 x 3/4" x 3/8"	1RAS316B00	16	EPDM	5	125	19,01
20 x 1" x 3/4"	1RAS320C00	16	EPDM	5	125	23,96
25 x 1 1/4" x 1"	1RAS325D00	16	EPDM	5	90	27,33
32 x 1 1/2" x 1"	1RAS332D00	16	EPDM	-	60	34,08
40 x 2" x 1 1/2"	1RAS340F00	16	EPDM	-	35	51,29
16 x 3/4" x 1/2"	1RAS316B10	16	FKM	5	125	21,24
20 x 1" x 3/4"	1RAS320C10	16	FKM	5	125	28,01
25 x 1 1/4" x 1"	1RAS325D10	16	FKM	5	90	31,70
32 x 1 1/2" x 1"	1RAS332D10	16	FKM	-	60	42,79
40 x 2" x 1 1/2"	1RAS340F10	16	FKM	-	35	60,88

Adaptador depósito.

H encolar - M-H roscar. Junta plana iuncluida.



LIV

d x Rm	Ref.	PN	Pack	U/ 	€ EPDM
25 x 1"	LIV025100	16	10	100	11,40
32 x 1 1/4"	LIV032114	16	10	40	13,29

Adaptador depósito.

M-M encolar - roscar. Junta plana incluida.



LIFV-J

d x Rm x Rh	Ref.	€ EPDM	€ FKM
16 x 3/4" x 1/2"	GP0195E	1,36	5,31
20 x 1" x 3/4"	GP2299E	2,56	14,83
25 x 1 1/4" x 1"	GP0200E	2,98	15,90
32 x 1 1/2" x 1"	GP0201E	3,76	22,91
40 x 2" x 1 1/2"	GP0202E	5,37	37,32

Junta plana para adaptador depósito.

Código en FKM termina en "F"
en lugar de "E"

LIV-J

d x Rm	Ref.	€ EPDM
25 x 1"	GP1205E	0,79
32 x 1 1/4"	GP1206E	1,10

Junta plana para adaptador depósito.

Junta en EPDM.



DIV

d x d1	Ref.	PN	Pack	U/ 	€
16 x 12	DIV016012	● 16	10	1.000	1,59
20 x 16	DIV020016	● 16	10	1.000	0,47
25 x 20	DIV025020	● 16	10	600	0,57
32 x 20	DIV032020	● 16	10	400	0,68
32 x 25	DIV032025	● 16	10	400	0,63
40 x 20	DIV040020	● 16	10	240	0,99
40 x 25	DIV040025	● 16	10	240	0,99
40 x 32	DIV040032	● 16	10	240	0,79
50 x 32	DIV050032	● 16	10	120	1,36
50 x 40	DIV050040	● 16	10	120	0,97
63 x 32	DIV063032	● 16	-	70	1,81
63 x 40	DIV063040	● 16	-	70	1,81
63 x 50	DIV063050	● 16	-	60	1,29
75 x 50	DIV075050	● 16	-	56	2,72
75 x 63	DIV075063	● 16	-	56	2,31
90 x 50	DIV090050	● 16	-	100	4,35
90 x 63	DIV090063	● 16	-	100	4,35
90 x 75	DIV090075	● 16	-	100	3,76
110 x 63	DIV110063	● 16	-	60	8,34
110 x 75	DIV110075	● 16	-	60	8,26
110 x 90	DIV110090	● 16	-	60	7,27
125 x 110	DIV125110	● 16	-	12	9,47
140 x 90	DIV140090	● 16	-	16	13,49
140 x 110	DIV140110	● 16	-	16	14,41

Casquillo reducción encolar.

M-H encolar.

d = diám.macho

d1 = diám.hembra

d x d1	Ref.	PN	Pack	U/ 	€
140 x 125	DIV140125	● 16	-	16	12,84
160 x 90	DIV160090	● 16	-	9	18,26
160 x 110	DIV160110	● 16	-	9	19,01
160 x 140	DIV160140	● 16	-	9	16,79
180 x 160*	DIV180160	10	-	1	52,54
200 x 160*	1RRC121O00	16	-	10	45,14
200 x 180*	DIV200180	10	-	1	52,83
225 x 160 A)	DIV225160	16	-	6	43,76
225 x 200 A)*	DIV225200	16	-	6	35,60
250 x 160	DIV250160	10	-	6	76,13
250 x 180*	DIV250180	10	-	1	158,18
250 x 200	DIV250200	10	-	6	65,18
250 x 225	DIV250225	10	-	6	63,87
280 x 200*	DIV280200	10	-	1	178,58
280 x 225*	DIV280225	10	-	4	178,58
280 x 250*	DIV280250	10	-	1	178,58
315 x 200	DIV315200	10	-	3	192,68
315 x 225	DIV315225	10	-	3	195,50
315 x 250	DIV315250	10	-	4	191,19
315 x 280	DIV315280	10	-	4	190,97
400 x 280*	DIV400280	5	-	1	315,36
400 x 315*	DIV400315	5	-	1	273,18
400 x 355*	DIV400355	5	-	1	273,18

A) Factor de seguridad reducido



RIV

d x d2 x d1	Ref.	PN	Pack	U/	€
16 x 12	RIV016012	16	10	800	0,73
20 x 16	RIV020016	16	10	500	0,73
25 x 20 x 16	RIV025020016	16	10	400	0,79
25 x 20 x 20	RIV025020020	16	10	340	0,79
32 x 25 x 16	RIV032025016	16	10	280	0,79
32 x 25 x 20	RIV032025020	16	10	240	0,87
32 x 25 x 25	RIV032025025	16	10	200	0,87
40 x 32 x 20	RIV040032020	16	10	120	1,07
40 x 32 x 25	RIV040032025	16	10	120	1,07
40 x 32 x 32	RIV040032032	16	10	120	1,07
50 x 40 x 20	RIV050040020	16	10	80	1,54
50 x 40 x 25	RIV050040025	16	10	80	1,54
50 x 40 x 32	RIV050040032	16	10	80	1,54
50 x 40 x 40	RIV050040040	16	10	60	1,54
63 x 50 x 25	RIV063050025	16	-	40	2,49
63 x 50 x 32	RIV063050032	16	-	40	2,49
63 x 50 x 40	RIV063050040	16	-	40	2,49
63 x 50 x 50	RIV063050050	16	-	35	2,49

Reducción cónica encolar.

M-H encolar.

d = diámetro macho

d2 y d1 = diámetros hembra



MRIV*

d2 x d1	Ref.	PN	U/	€
125 x 110	MRIV125110	10	1	57,51
140 x 110	MRIV140110	10	1	76,71
140 x 125	MRIV140125	10	1	76,71
160 x 110	MRIV160110	10	1	78,77
160 x 125	MRIV160125	10	1	81,63
160 x 140	MRIV160140	10	1	78,77
200 x 110	MRIV200110	10	1	152,19
200 x 125	MRIV200125	10	1	152,19
200 x 140	MRIV200140	10	1	152,19
200 x 160	MRIV200160	10	1	152,19
200 x 180	MRIV200180	10	1	152,19
225 x 110	MRIV225110	10	1	195,69
225 x 125	MRIV225125	10	1	195,69
225 x 140	MRIV225140	10	1	190,11
225 x 160	MRIV225160	10	1	190,11
225 x 200	MRIV225200	10	1	190,11
250 x 110	MRIV250110	10	1	245,92
250 x 125	MRIV250125	10	1	245,92
250 x 140	MRIV250140	10	1	245,92
250 x 160	MRIV250160	10	1	238,97
250 x 180	MRIV250180	10	1	238,97
250 x 200	MRIV250200	10	1	238,97

Manguito reducido encolar.

H-H encolar.

d x d1	Ref.	PN	Pack	U/	€
75 x 63 x 50	RIV075063050	16	-	24	3,98
75 x 63 x 63	RIV075063063	16	-	24	3,98
90 x 75 x 50 x 40 B)	RIV090075040	16	-	24	5,18
90 x 75 x 63 x 50 B)	RIV090075050	16	-	16	5,18
90 x 75 x 75 x 63 B)	RIV090075063	16	-	24	5,18
90 x 75 x 90 x 75 B)	RIV090075075	16	-	12	5,18
110 x 90 x 50	RIV110090050	16	-	15	9,45
110 x 90 x 63	RIV110090063	16	-	12	9,45
110 x 90 x 75	RIV110090075	16	-	12	9,45
110 x 90 x 90	RIV110090090	16	-	10	9,45
125 x 110 x 63*	RIV125063	16	-	1	40,83
125 x 110 x 75*	RIV125075	16	-	1	34,68
125 x 110 x 90*	RIV125090	16	-	1	34,68
140 x 125 x 75*	RIV140075	16	-	1	57,80
140 x 125 x 90*	RIV140090	16	-	1	52,05
140 x 125 x 110*	RIV140110	16	-	1	52,05
160 x 140 x 90*	RIV160090	16	-	1	104,94
160 x x 110	RIV160110	16	-	12	22,54
200 x x 160	RIV200160	16	-	8	49,33

B) 4 diámetros M-H / M-H

d2 x d1	Ref.	PN	U/	€
250 x 225	MRIV250225	10	1	238,97
280 x 110	MRIV280110	10	1	280,42
280 x 125	MRIV280125	10	1	280,42
280 x 140	MRIV280140	10	1	280,42
280 x 160	MRIV280160	10	1	280,42
280 x 200	MRIV280200	10	1	272,49
280 x 225	MRIV280225	10	1	272,49
280 x 250	MRIV280250	10	1	272,49
315 x 160	MRIV315160	8	1	312,25
315 x 180	MRIV315180	8	1	312,25
315 x 200	MRIV315200	8	1	296,95
315 x 225	MRIV315225	8	1	296,95
315 x 250	MRIV315250	8	1	296,95
315 x 280	MRIV315280	8	1	296,95
355 x 315	MRIV355315	5	1	322,42
400 x 160	MRIV400160	5	1	401,09
400 x 225	MRIV400225	5	1	401,09
400 x 280	MRIV400280	5	1	401,09
400 x 315	MRIV400315	5	1	343,51
400 x 355	MRIV400355	5	1	364,56
500 x 400	MRIV500400	4	1	563,49

d2 y d1 = diámetros hembra

**CIV**

d	Ref.	PN	Pack	U/ 	€
12	CIV012	16	10	1.000	1,10
16	CIV016	16	10	1.000	0,57
20	CIV020 ●	16	10	600	0,57
25	CIV025 ●	16	10	400	0,60
32	CIV032 ●	16	10	240	0,81
40	CIV040 ●	16	10	140	1,23
50	CIV050 ●	16	10	80	1,77
63	CIV063 ●	16	-	60	2,49
75	CIV075 ●	16	-	28	4,68
90	CIV090 ●	16	-	15	7,64
110	CIV110 ●	16	-	10	15,45
125	CIV125	16	-	6	21,65
140	CIV140	16	-	4	28,29
160	CIV160 ●	16	-	4	32,72
200*	CIV200 ●	10	-	7	47,07
225	CIV225	10	-	2	76,47
250*	CIV250	10	-	1	162,47

Tapón encolar hembra.
H encolar.

**CFV**

Rh	Ref.	PN	Pack	U/ 	€
3/8"	1RCA216000	16	10	1.000	1,77
1/2"	CFV012 ●	16	10	500	1,10
3/4"	CFV034	16	10	400	1,20
1"	CFV100	16	10	200	1,49
1 1/4"	CFV114	16	10	140	2,09
1 1/2"	CFV112	16	10	90	2,72
2"	CFV200	16	-	50	3,61
2 1/2"	CFV212	16	-	70	13,47
3"	CFV300	16	-	20	13,81
4"	CFV400	16	-	60	23,80

Tapón rosca hembra.
H roscar.

**PFV**

Rm	Ref.	PN	Pack	U/ 	€
3/8"	PFV038	16	10	1.000	0,65
1/2"	PFV012 ●	16	10	300	0,79
3/4"	PFV034	16	10	400	0,94
1"	PFV100 ●	16	10	260	1,34
1 1/4"	PFV114	16	10	120	1,77
1 1/2"	PFV112	16	10	100	2,31
2"	PFV200	16	-	60	2,72
2 1/2"	PFV212	16	-	36	4,83
3"	PFV300	16	-	20	7,79
4"	PFV400	16	-	8	15,25

Tapón rosca macho.
M roscar.

**DFV**

Rm x Rh	Ref.	PN	Pack	U/ 	€
1/2" x 3/8"	DFV012038 ●	16	10	600	1,34
3/4" x 1/2"	DFV034012 ●	16	10	400	1,20
1" x 3/4"	DFV100034 ●	16	10	280	1,47
1 1/4" x 1"	DFV114100 ●	16	10	160	1,75
1 1/2" x 1 1/4"	DFV112114 ●	16	10	100	2,07
2" x 1 1/2"	DFV200112	16	-	60	3,14

Reducción roscada corta.
M-H roscar.



KIFV

dm x dh x Rm	Ref.	PN	Pack	U/	€
16 x 12 x 3/8"	KIFV16012038	16	10	700	2,19
20 x 16 x 3/4"	KIFV20016038	16	10	700	0,75
20 x 16 x 1/2"	KIFV20016012	16	10	700	0,75
25 x 20 x 1/2"	KIFV25020012	16	10	350	0,89
25 x 20 x 3/4"	KIFV25020034	16	10	300	0,89
32 x 25 x 1/2"	KIFV32025012	16	10	220	0,99
32 x 25 x 3/4"	KIFV32025034	16	10	200	0,99
32 x 25 x 1"	KIFV32025100	16	10	180	0,99
40 x 32 x 3/4"	KIFV40032034	16	10	120	1,34
40 x 32 x 1"	KIFV40032100	16	10	120	1,34
40 x 32 x 1 1/4"	KIFV40032114	16	10	100	1,34
50 x 40 x 1"	KIFV50040100	16	10	100	1,72
50 x 40 x 1 1/4"	KIFV50040114	16	10	100	1,72
50 x 40 x 1 1/2"	KIFV50040112	16	10	100	1,70

Terminal rosca macho.

M/H encolar - M roscar



NFV

Rm	Ref.	PN	Pack	U/	€
3/8"	NFV038	16	10	800	0,89
1/2"	NFV012	16	10	500	0,94
3/4"	NFV034	16	10	260	1,10
1"	NFV100	16	10	160	1,34
1 1/4"	NFV114	16	10	80	1,65
1 1/2"	NFV112	16	10	70	2,17
2"	NFV200	16	-	30	2,77
2 1/2" A)	NFV212	16	-	24	4,89
3" A)	NFV300	16	-	16	7,64
4" A)	NFV400	16	-	6	17,99

Machón doble rosca.

A) Factor de seguridad reducido

M-M roscar.



RFV

Rm x Rh	Ref.	PN	Pack	U/	€
1/2" x 3/8"	RFV012038	16	10	500	1,29
3/4" x 3/8"	RFV034038	16	10	400	1,41
3/4" x 1/2"	RFV034012	16	10	320	1,39
1" x 3/8"	RFV100038	16	10	240	1,67
1" x 1/2"	RFV100012	16	10	200	1,57
1" x 3/4"	RFV100034	16	10	200	1,57
1 1/4" x 1/2"	RFV114012	16	10	100	1,99
1 1/4" x 3/4"	RFV114034	16	10	80	1,99
1 1/4" x 1"	RFV114100	16	10	80	1,94
1 1/2" x 1/2"	RFV112012	16	10	80	2,25
1 1/2" x 3/4"	RFV112034	16	10	80	2,27
1 1/2" x 1"	RFV112100	16	10	80	2,25
1 1/2" x 1 1/4"	RFV112114	16	10	80	2,25
2" x 3/4"	RFV200034	16	-	50	3,35
2" x 1"	RFV200100	16	-	40	3,35
2" x 1 1/4"	RFV200114	16	-	40	3,40
2" x 1 1/2"	RFV200112	16	-	40	3,29
2 1/2" x 2"	RFV212200	16	-	36	4,47
3" x 2"	RFV300200	16	-	20	5,60
3" x 2 1/2"	RFV300212	16	-	20	7,77
4" x 3"	RFV400300	16	-	8	17,86

Reducción roscada.

M-H roscar

dm = diámetro macho dh = diámetro hembra

Rm = rosca macho



NRFV

Rm x Rm	Ref.	PN	Pack	U/ 	€
¾" x ½"	NRFV034012	● 16	10	300	0,97
1" x ¾"	NRFV100034	● 16	10	200	1,29
1¼" x 1"	NRFV114100	● 16	10	120	1,57
1½" x 1¼"	NRFV112114	● 16	10	80	1,91
2" x 1½"	NRFV200112	● 16	-	40	2,41
2½" x 2"	NRFV212200	16	-	24	4,47
3" x 2½"	NRFV300212	16	-	16	7,24
4" x 3"	NRFV400300	16	-	8	16,66

Machón reducido roscado.

M-M roscar.



NRIV

d x Rh	Ref.	Pack	U/ 	€
25 x 1"	NRIV025100	10	120	3,51
32 x 1¼"	NRIV032114	10	60	4,53

Adaptador M-M.

M encolar - roscar.



IFFV

Rh x Rm	Ref.	PN	Pack	U/ 	€
¾" x ½"	IFFV034012	● 16	10	280	1,39
1" x ½"	IFFV100012	16	10	140	5,65
1" x ¾"	IFFV100034	16	10	140	1,62
1¼" x 1"	IFFV114100	16	10	80	1,94
1½" x 1¼"	IFFV112114	16	10	40	2,33
2" x 1½"	IFFV200112	16	-	30	3,11
2½" x 2"	IFFV212200	16	-	20	20,58
3" x 2½"	IFFV300212	16	-	16	12,19
4" x 3"	IFFV400300	16	-	8	60,13

Reducción roscada.

H-M roscar.



JFV

Rh	Ref.	PN	Pack	U/ 	€
½"	JFV012	16	25	1.000	6,75
¾"	JFV034	16	25	750	7,19
1"	JFV100	16	25	400	7,84
1¼"	JFV114	16	10	300	8,63
1½"	JFV112	16	10	200	Consultar
2"	JFV200	16	10	120	Consultar

Tuerca fina.

H roscar. Para adaptador depósito LIV y LIFV.

**BIV**

d	Ref.	PN	Pack	U/	€ EPDM
16	BIV016E	16	10	300	2,14
20	BIV020E	16	10	180	2,09
25	BIV025E	16	10	100	2,41
32	BIV032E	16	10	70	3,43
40	BIV040E	16	10	40	4,13
50	BIV050E	16	10	90	5,05
63	BIV063E	16	5	45	7,37
75	BIV075E	10	-	28	21,39
90	BIV090E	10	-	22	28,29
110	BIV110E	10	-	12	41,40

Unión 3 piezas encolar.
H-H encolar. Junta en EPDM.

Para recambios consultar
el apartado "Recambios"
de esta misma tarifa

**BIFV**

d x Rh	Ref.	PN	Pack	U/	€ EPDM
16 x 3/8"	BIFV016038E	16	10	300	2,41
20 x 1/2"	BIFV020012E	16	10	180	2,46
25 x 3/4"	BIFV025034E	16	10	100	2,88
32 x 1"	BIFV032100E	16	10	60	3,87
40 x 1 1/4"	BIFV040114E	16	10	40	4,87
50 x 1 1/2"	BIFV050112E	16	10	90	5,83
63 x 2"	BIFV063200E	16	5	60	8,50
75 x 2 1/2"	BIFV075212E	10	-	28	23,75
90 x 3"	BIFV090300E	10	-	22	30,31
110 x 4"	BIFV110400E	10	-	12	48,15

Unión 3 piezas mixto.
H-H encolar - rosca. Junta en EPDM.

Para recambios consultar
el apartado "Recambios"
de esta misma tarifa

**BIRV**

d x Rm	Ref.	PN	Pack	U/	€ EPDM
20 x 1/2" *	BIRV020012E	16	-	25	3,09
25 x 3/4" *	BIRV025034E	16	-	30	3,43
32 x 1" *	BIRV032100E	16	-	50	4,42
40 x 1 1/4" *	BIRV040114E	16	-	36	5,13
50 x 1 1/2"	BIRV050112E	16	10	80	6,12
50 x 2"	BIRV050200E	16	10	80	9,26
63 x 2"	BIRV063200E	16	5	35	8,48
75 x 2 1/2" *	BIRV075212E	16	-	12	25,92
90 x 3" *	BIRV090300E	16	-	18	33,95

Unión 3 piezas mixto.
H-M encolar - rosca. Junta en EPDM.

Para recambios consultar
el apartado "Recambios"
de esta misma tarifa

**BFV**

Rh	Ref.	PN	Pack	U/	€ EPDM
3/8"	BFV038E	16	10	300	2,74
1/2"	BFV012E	16	10	180	2,96
3/4"	BFV034E	16	10	100	3,48
1"	BFV100E	16	10	60	4,65
1 1/4"	BFV114E	16	10	40	5,83
1 1/2"	BFV112E	16	10	90	6,87
2"	BFV200E	16	5	60	9,78
2 1/2" **	1RBO275000	10	-	15	42,84
3" **	1RBO290000	6	-	12	73,27
4" **	1RBO211000	6	-	12	83,41

Unión 3 piezas roscado.
H-H rosca. Junta en EPDM.

Para recambios consultar
el apartado "Recambios"
de esta misma tarifa

**BIFOV**

d x Rh	Ref.	PN	Pack	U/	€ EPDM
16 x 3/8"	BIFOV016038E	16	50	100	8,86
20 x 1/2"	BIFOV020012E	16	40	80	11,49
25 x 3/4"	BIFOV025034E	16	20	40	14,65
32 x 1"	BIFOV032100E	16	14	28	18,41
40 x 1 1/4"	BIFOV040114E	16	8	16	25,89
50 x 1 1/2"	BIFOV050112E	16	4	8	32,32
63 x 2"	BIFOV063200E	16	-	12	52,62

Unión 3 piezas mixto PVC-U / Latón.
H-H encolar - rosca latón. Junta en EPDM.

Para recambios consultar
el apartado "Recambios"
de esta misma tarifa

**BIROV**

d x Rm	Ref.	PN	Pack	U/	€ EPDM
16 x 3/8"	BIROV016038E	16	50	100	10,65
20 x 1/2"	BIROV020012E	16	35	70	12,39
25 x 3/4"	BIROV025034E	16	15	30	16,24
32 x 1"	BIROV032100E	16	12	24	20,87
40 x 1 1/4"	BIROV040114E	16	8	16	30,28
50 x 1 1/2"	BIROV050112E	16	4	8	36,09
63 x 2"	BIROV063200E	16	-	10	62,40

Unión 3 piezas mixto PVC-U / Latón.
H-M encolar - rosca latón. Junta en EPDM.

Para recambios consultar
el apartado "Recambios"
de esta misma tarifa

**BIFXV**

d x Rh	Ref.	PN	Pack	€ EPDM	€ FKM
16 x 3/8"	BIFXV016038E	16	50	30,92	32,79
20 x 1/2"	BIFXV020012E	16	40	33,01	35,00
25 x 3/4"	BIFXV025034E	16	20	37,84	39,65
32 x 1"	BIFXV032100E	16	14	43,63	45,98
40 x 1 1/4"	BIFXV040114E	16	8	61,83	64,03
50 x 1 1/2"	BIFXV050112E	16	4	68,13	72,10
63 x 2"	BIFXV063200E	16	-	86,67	90,68

Unión 3 piezas mixto
PVC-U / Inox A316L.
H-H encolar - roscar inox.
Junta en EPDM o FKM.

Código en FKM termina en "F"
en lugar de "E"
Para recambios consultar
el apartado "Recambios"
de esta misma tarifa

**BIRXV**

d x Rm	Ref.	PN	Pack	€ EPDM	€ FKM
16 x 3/8"	BIRXV016038E	16	50	33,16	34,86
20 x 1/2"	BIRXV020012E	16	35	35,13	36,95
25 x 3/4"	BIRXV025034E	16	15	39,51	41,22
32 x 1"	BIRXV032100E	16	12	44,56	47,21
40 x 1 1/4"	BIRXV040114E	16	8	61,83	66,43
50 x 1 1/2"	BIRXV050112E	16	4	73,44	77,05
63 x 2"	BIRXV063200E	16	-	101,43	110,73

Unión 3 piezas mixto
PVC-U / Inox A316L.
H-M encolar - roscar inox.
Junta en EPDM o FKM.

Código en FKM termina en "F"
en lugar de "E"
Para recambios consultar
el apartado "Recambios"
de esta misma tarifa

**ADV**

Rh x P1 x P2	Ref.	PN	Pack	U/	€ EPDM
1/2" x 12 x 14	ADV012012014	16	5	300	1,89
3/4" x 16 x 18	ADV034016018	16	5	200	2,31
1" x 20 x 22	ADV100020022	16	5	160	2,61
1 1/4" x 25 x 27	ADV114025027	16	5	80	2,98
1 1/2" x 30 x 32	ADV112030032	16	5	50	3,85
2" x 40 x 42	ADV200040042	16	5	30	3,76
2" x 50 x 52	ADV200050052	16	5	25	4,63
2 1/4" x 50 x 52	ADV214050052	16	5	20	11,27
2 3/4" x 60 x 64	ADV234060064	16	3	21	5,55

Espiga con tuerca.
H-M roscar - presión. Junta en EPDM.

**ADV-J**

R x P1 x P2	Ref.	€ EPDM
1/2" x 12 x 14	GP1210E	0,39
3/4" x 16 x 18	GP0193E	0,45
1" x 20 x 22	GP1212E	0,45
1 1/4" x 25 x 27	QHVX025E	0,73
1 1/2" x 30 x 32	GP0196E	0,63
2" x 40 x 42	GP0197E	0,89
2" x 50 x 52	GP0197E	0,89
2 1/4" x 50 x 52	GP0198E	1,15
2 3/4" x 60 x 64	QHVX050E	1,54
3 3/4" x 60 x 64	GPO0199E	2,79

Junta plana EPDM
Para espiga con tuerca ADV

**AFV**

d x P2 x P1	Ref.	PN	Pack	U/	€ EPDM
12 x 14 x 12	AIV012014012	16	10	1.000	0,68
16 x 18 x 16	AIV016018016	16	10	600	0,68
20 x 22 x 20	AIV020022020	16	10	500	0,87
25 x 27 x 25	AIV025027025	16	10	200	1,05
32 x 32 x 30	AIV032032030	16	10	100	1,31
40 x 42 x 40	AIV040042040	16	5	100	1,54
50 x 52 x 50	AIV050052050	16	5	40	2,19
63 x 64 x 60	AIV063064060	16	-	40	2,79

Espiga encolar macho.
M-M encolar - presión.

**AFV**

Rm x P1 x P2	Ref.	PN	Pack	U/	€
1/4" x 12 x 14	AFV014012014	16	10	1.000	0,68
3/8" x 16 x 18	AFV038016018	16	10	600	0,65
1/2" x 20 x 22	AFV012020022	16	10	300	0,87
3/4" x 25 x 27	AFV034025027	16	10	160	1,02
1" x 30 x 32	AFV100030032	16	10	100	1,31
1 1/4" x 40 x 42	AFV114040042	16	5	50	1,57
1 1/2" x 50 x 52	AFV112050052	16	5	30	2,25
2" x 60 x 64	AFV200060064	16	-	20	2,83

Espiga rosca macho.
M-M roscar - presión.



PINZA*

d	Ref.	Pack	€
16**	1RST116000	10	0,57
20**	1RST120000 ●	10	0,52
25**	1RST125000 ●	10	0,65
32**	1RST132000 ●	10	0,75
40	1RST140000 ●	10	1,52
50	1RST150000 ●	10	1,91
63	1RST163000 ●	10	2,22
75	1RST175000	10	2,96
90	1RST190000	10	3,90
110	1RST111000	10	4,55

Abrazadera para tubería PP gris.
Marca ASTORE.

** En estos diámetros
sin cierre superior



ZIKM

d	Ref.	Pack	U/☐	€
16	ZIKM016	10	800	1,47
20	ZIKM020 ●	10	600	1,57
25	ZIKM025 ●	10	160	1,62
32	ZIKM032 ●	10	240	1,94
40	ZIKM040 ●	10	160	2,38
50	ZIKM050 ●	10	100	2,74
63	ZIKM063 ●	10	80	3,40
75	ZIKM075 ●	-	80	4,81
90	ZIKM090	-	40	5,85
110	ZIKM110	-	30	8,19
125	ZIKM125	-	20	11,09
140	ZIKM140	-	20	11,59
160	ZIKM160	-	10	13,34
180	ZIKM180	-	10	12,19

Abrazadera para tubería PP gris.



	Ref.	U/☐	☐ n.º	€/Unid.
125 ml	035001	96	A-8	6,28
Bote 250 ml	035008	24	A-11	13,76
Bote 500 ml	035002	20	A-8	19,11
Bote 1.000 ml	035003	12	A-8	31,76

Adhesivo NEW GENERATION.

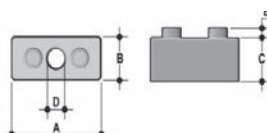

DSM

d	Ref.	A	B	C	D	E	€
32	DSM032	33	16	14	8	4	1,05
40	DSM040	41	17	17	8	4	1,41
50	DSM050	51	18	17	8	4	1,91
63	DSM063	64	19	22,5	8	4	2,51
75	DSM075	76	20	34,5	8	4	3,45

Soporte en PP para abrazadera ZIKM.



COBRA*

d	Ref.	Pack	U/☐	€
16**	COBRA016 ●	10	50	0,56
20**	COBRA020 ●	10	50	1,10
25**	COBRA025 ●	10	50	1,38
32	COBRA032 ●	10	10	2,80
40	COBRA040 ●	10	10	3,48
50	COBRA050 ●	10	10	3,62
63	COBRA063 ●	10	10	5,58
75	COBRA075	10	10	11,45
90	COBRA090	10	10	13,66
110	COBRA110	10	10	18,95
125	COBRA125	10	10	37,39
140	COBRA140	-	10	39,98
160	COBRA160	-	10	45,57

Abrazadera para tubería PP negro.
Marca DURAPIPE

** En estos diámetros sin
cierre superior



	Ref.	U/☐	☐ n.º	€/Unid.
Bote 500 ml	035007	24	A-8	11,46

Limpiador.
Desengordurante.

Lleva el agua y la energía de forma sostenible sin límites

Sistemas de conducción de fluidos

Infraestructura



Comunicaciones



Protección contra incendios



Suministro de agua



Suministro de gas e hidrógeno

Industria



Procesos industriales



Medición y control



Prefabricado industrial



Tratamiento de agua

 Seguridad  Calidad  Durabilidad  Fácil instalación

Descarga nuestro catálogo de soluciones



Grupo internacional con dos plantas de fabricación en España
Alicante Okondo
+ 45 países

Válvulas de bola 2 y 3 vías
Válvulas de mariposa
Válvulas y grifos de membrana
Válvulas de retención
Filtros inclinados



0802

Válvulas manuales en PVC-U presión

INDUSTRIA



Más información



Bloqueo de las tuercas

Para asegurar la PN y aflojes por vibraciones elevadas



Válvulas de bola

Tapón portaetiqueta

Tapón para personalizar o señalar la válvula.



Bidireccional.
Sin dirección de montaje.
Sin flecha en el cuerpo

Plena libertad y seguridad a la hora del montaje. Se pueden instalar sin necesidad de seguir la dirección de montaje. Mucho más fácil y sin riesgo de que se desmonte o bloquee la bola por la presión del fluido al desmontar el extremo que da acceso a la misma. Tampoco se bloquea la bola si nos excedemos al apretar los extremos. Por tanto el eje no sufre ni se rompe.

Tapón de protección transparente con porta etiqueta para el sistema de Labelling Easyfit (opcional)

Optional transparent service plug with tag holder for Easyfit Labelling system



Tapón de protección estándar
Grey standard service plug

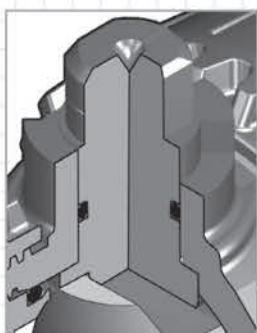

Eje y esfera de tipo flotante de alta finura superficial

High finishing stem and floating ball

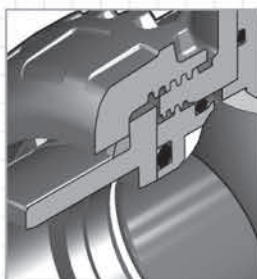

Casquillo roscado de seguridad

Safe blocked carrier



Montaje radial según norma EN 1452 "short"

True union installation according to EN 1452 "short"



Maneta multifunción Easyfit
Easyfit multifunctional handle

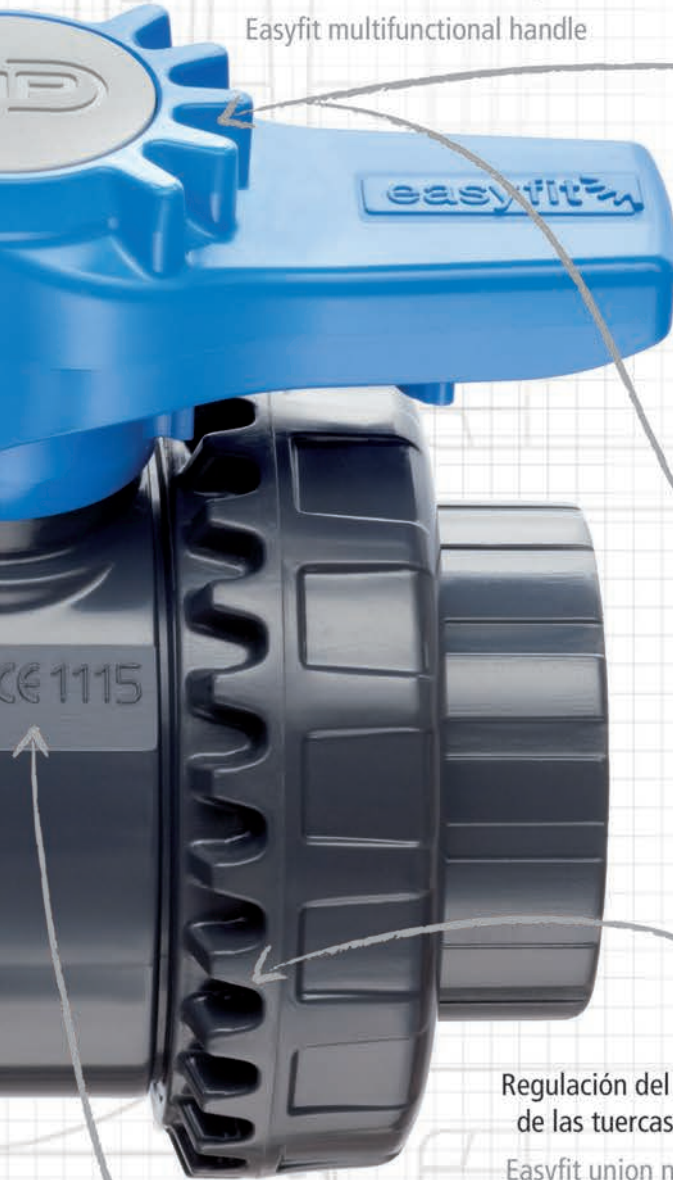

Control rotación tuercas
Union nut rotation control



Regulación casquillo estanco y bola
Ball seat carrier adjustment



Regulación del apriete
de las tuercas Easyfit
Easyfit union nut gear
tightening



Cuerpo de la válvula PN16
Certificado 97/23/CE

Valve body PN16
97/23/CE Certified



Sistema de etiquetado:

sistema completo de etiquetado que identifica la válvula según necesidades específicas.

Labelling System:

complete tagging system that allows the identification of the valve according to specific needs.



Rendimiento y seguridad:

válvula ligera y compacta con cuerpo PN16 en PVC-U K62 o PVC-C Corzan y doble junta tórica en el eje de la válvula. El acabado de gran calidad de la bola, el asiento de bola y el disco anti-fricción en PTFE situado en la base del eje minimizan las fricciones logrando un excelente funcionamiento de par de torsión.



The high surface finished ball, the PTFE ball seat and the PTFE anti-friction disc located at the base of the stem minimize the frictions achieving excellent operating torque.

Performance and safety:

light and compact valve with PN16 body in PVC-U K62 or PVC-C Corzan™ and double O-ring seal on the valve stem.

The high surface finished ball, the PTFE ball

Cerradura a prueba de manipulaciones:

la válvula está equipada con un sistema simple que evita la rotación de la maneta tanto de apertura como de cierre mediante un candado.

Fácil accionamiento:

el cuerpo de la válvula tiene una estructura integrada para fijar el kit de actuación PowerQuick, específico para la instalación de actuadores neumáticos y eléctricos.

Easy

actuation:

the valve body has an integrated structure for anchoring the special PowerQuick module, dedicated to the installation of pneumatic and electric actuators.

Tamper-proof lock:

the valve is equipped with a simple system that avoid the handle rotation both for opening and closing operations inputting a padlock.





Gama VXE

Maneta multifuncional Easyfit
Easyfit multifunctional handle

Maneta multifunción Easyfit de rápida extracción:
para usar la maneta como herramienta multifuncional para apretar las tuercas de unión y ajustar el soporte de asiento de bola se puede extraer del dedo con una simple maniobra permaneciendo firme al eje que se está maniobrando.



Easyfit Quick-release multifunctional handle:
the handle, to be used as multifunction tool for union nuts tightening and ball seat carrier adjustment can be removed with a simple operation from the hub which remains firmly coupled to the maneuvering stem.



Bisel giratorio con la maneta multifuncional Easyfit:

el uso del gancho alojado en el interior de la maneta permite crear una llave para el ajuste de las tuercas de unión que asegura un acoplamiento seguro y sólido.



Ajuste del casquillo de la bola de apoyo con la maneta multifuncional Easyfit.

Ball seat carrier adjustment with Easyfit multifunctional handle.



Union nut tightening with Easyfit multifunctional handle:
the use of the hooked insert housed inside the handle allows to realize a key for the union nuts rotation that ensures a secure and solid engagement.



Maneta multifunción
Multi functional handle



Kit de montaje para actuadores
Mounting flange

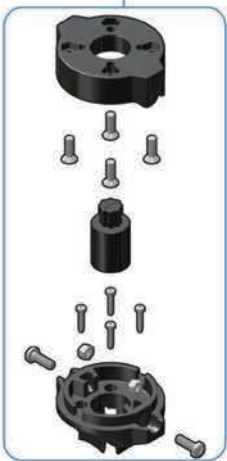

Soporte de fijación
Bracketing



Gama VKD

Válvula industrial



Conexión eje y bola
Stem-ball connection

Soporte del asiento de la bola
Safe blocked carrier

Dual Block
Dual Block

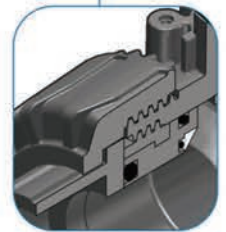

Cuerpo
Body





INDUSTRIA

Válvulas manuales de PVC-U presión

Válvulas de bola 2 vías

**VEEIV**

d	Ref.	DN	PN	U/	€ EPDM
16	VEEIV016E	10	16	90	10,95
20	VEEIV020E	15	16	90	10,95
25	VEEIV025E	20	16	55	12,11
32	VEEIV032E	25	16	35	15,90
40	VEEIV040E	32	16	20	18,51
50	VEEIV050E	40	16	15	25,32
63	VEEIV063E	50	16	8	34,47

Válvula de bola maneta azul.

H-H encolar. Junta EPDM - Asiento PE. Bidireccional.**VEEFV**

Rh	Ref.	DN	PN	U/	€ EPDM
3/8"	VEEFV038E	10	16	90	11,51
1/2"	VEEFV012E	15	16	90	11,51
3/4"	VEEFV034E	20	16	55	12,69
1"	VEEFV100E	25	16	35	16,84
1 1/4"	VEEFV114E	32	16	20	19,77
1 1/2"	VEEFV112E	40	16	15	26,99
2"	VEEFV200E	50	16	8	36,64

Válvula de bola maneta azul.

H-H roscar. Junta EPDM - Asiento PE. Bidireccional.**VEEIV**

d	Ref.	DN	PN	U/	€ EPDM
75	VEEIV075E	65	16	2	102,37
90	VEEIV090E	80	16	2	139,35
110	VEEIV110E	100	16	1	249,09

Válvula de bola maneta azul.

H-H encolar. Junta EPDM - Asiento PE. Bidireccional.**VEEFV**

Rh	Ref.	DN	PN	U/	€ EPDM
2 1/2"	VEEFV212E	65	16	2	107,60
3"	VEEFV300E	80	16	2	144,84
4"	VEEFV400E	100	16	1	262,82

Válvula de bola maneta azul.

H-H roscar. Junta EPDM - Asiento PE. Bidireccional.

Para recambios de las válvulas consultar el último apartado "Recambios" de esta misma tarifa.



VXEIV

d	Ref. EPDM	DN	PN	U/	€ EPDM	€ FKM
16	VXEIV016E	10	16	30	14,07	16,84
20	VXEIV020E	15	16	30	14,13	16,89
25	VXEIV025E	20	16	30	16,69	20,22
32	VXEIV032E	25	16	20	19,61	23,75
40	VXEIV040E	32	16	14	25,53	30,18
50	VXEIV050E	40	16	6	31,41	36,99
63	VXEIV063E	50	16	6	41,82	53,59

Válvula de bola maneta naranja.

H-H encolar. Asiento PTFE (teflón).

Bidireccional.

Código en FKM termina en "F" en lugar de "E"



VXEFV

Rh	Ref. EPDM	DN	PN	U/	€ EPDM	€ FKM
3/8"	VXEFV038E	10	16	30	15,48	18,46
1/2"	VXEFV012E	15	16	30	15,53	18,46
3/4"	VXEFV034E	20	16	30	18,33	21,89
1"	VXEFV100E	25	16	20	21,99	26,10
1 1/4"	VXEFV114E	32	16	14	28,59	33,21
1 1/2"	VXEFV112E	40	16	6	34,55	40,10
2"	VXEFV200E	50	16	6	51,03	62,77

Válvula de bola maneta naranja.

H-H roscar. Asiento PTFE (teflón).

Bidireccional.

Código en FKM termina en "F" en lugar de "E"



VXEIV

d	Ref. EPDM	DN	PN	€ EPDM	€ FKM
75	VXEIV075E	65	16	110,76	121,85
90	VXEIV090E	80	16	150,83	165,92
110	VXEIV110E	100	16	309,85	340,81

Válvula de bola maneta naranja.

H-H encolar. Asiento PTFE (teflón).

Bidireccional.

Código en FKM termina en "F" en lugar de "E"



VXEFV

Rh	Ref. EPDM	DN	PN	€ EPDM	€ FKM
2 1/2"	VXEFV212E	65	16	124,34	240,62
3"	VXEFV300E	80	16	164,72	299,70
4"	VXEFV400E	100	16	346,10	381,56

Válvula de bola maneta naranja.

H-H roscar. Asiento PTFE (teflón).

Bidireccional.

Código en FKM termina en "F" en lugar de "E"

Para recambios de las válvulas consultar el último apartado "Recambios" de esta misma tarifa.

**VPE***

Rh x d	Ref. EPDM	PN	U/	€ EPDM
3/8" x 16	VPE038016	16	120	18,07
1/2" x 20	VPE012020	16	100	18,07
3/4" x 25	VPE034025	16	60	20,82
1" x 32	VPE100032	16	40	23,01
1 1/4" x 40	VPE114040	16	20	35,55
1 1/2" x 50	VPE112050	16	15	40,85
2" x 63	VPE200063	16	8	61,65

Válvula de bola.

PVC roscar hembra. Enlace PE H.

**VKDFV**

Rh	Ref. EPDM	DN	PN	€ EPDM	€ FKM
3/8"	VKDFV038E	10	16	42,79	51,75
1/2"	VKDFV012E	15	16	44,83	53,64
3/4"	VKDFV034E	20	16	53,64	62,22
1"	VKDFV100E	25	16	65,85	82,94
1 1/4"	VKDFV114E	32	16	83,67	97,79
1 1/2"	VKDFV112E	40	16	109,69	127,53
2"	VKDFV200E	50	16	138,15	173,55

Válvula de bola DUAL BLOCK®.

H-H roscar. Asiento PTFE (teflón).

Bidireccional.

Código en FKM termina en "F" en lugar de "E"

**VKDIV**

d	Ref. EPDM	DN	PN	€ EPDM	€ FKM
16	VKDIV016E	10	16	39,68	48,09
20	VKDIV020E	15	16	41,30	49,41
25	VKDIV025E	20	16	48,86	59,24
32	VKDIV032E	25	16	60,83	73,57
40	VKDIV040E	32	16	75,77	89,61
50	VKDIV050E	40	16	97,65	114,97
63	VKDIV063E	50	16	121,61	155,79

Válvula de bola DUAL BLOCK®.

H-H encolar. Asiento PTFE (teflón).

Bidireccional.

Código en FKM termina en "F" en lugar de "E"

**VKDFV**

Rh	Ref. EPDM	DN	PN	€ EPDM	€ FKM
2 1/2"	VKDFV212E	65	16	395,63	467,81
3"	VKDFV300E	80	16	504,03	592,10
4"	VKDFV400E	100	16	566,83	688,32

Válvula de bola DUAL BLOCK®.

H-H roscar. Asiento PTFE (teflón).

Bidireccional.

Código en FKM termina en "F" en lugar de "E"

**VKDIV**

d	Ref. EPDM	DN	PN	€ EPDM	€ FKM
75	VKDIV075E	65	16	366,31	438,50
90	VKDIV090E	80	16	466,71	554,75
110	VKDIV110E	100	16	524,83	646,31

Válvula de bola DUAL BLOCK®.

H-H encolar. Asiento PTFE (teflón).

Bidireccional.

Código en FKM termina en "F" en lugar de "E"



d	Ref.	DN	PN	€
140	052322	125	10	753,48

Válvula de bola PASO TOTAL con bridas

Sugerencia tornillería M6x100

Para recambios de las válvulas consultar el último apartado "Recambios" de esta misma tarifa.

**VKDDV**

d	Ref. EPDM	DN	PN	€ EPDM	€ FKM
16	VKDDV016E	10	16	39,68	48,09
20	VKDDV020E	15	16	41,30	49,41
25	VKDDV025E	20	16	48,86	59,24
32	VKDDV032E	25	16	60,83	73,57
40	VKDDV040E	32	16	75,77	89,61
50	VKDDV050E	40	16	97,65	114,97
63	VKDDV063E	50	16	121,61	155,79

Válvula de bola DUAL BLOCK®.
M-M encolar. Asiento PTFE (teflón).
Bidireccional.

Código en FKM termina en "F"
en lugar de "E"

**VKDBEV**

d	Ref. EPDM	DN	PN	€ EPDM	€ FKM
20	VKDBEV020E	15	16	49,83	68,26
25	VKDBEV025E	20	16	50,11	65,15
32	VKDBEV032E	25	16	57,82	77,67
40	VKDBEV040E	32	16	74,88	98,05
50	VKDBEV050E	40	16	92,45	120,63
63	VKDBEV063E	50	16	121,33	161,61

Válvula de bola DUAL BLOCK®.
Long spigot PE100 SDR11.
Asiento PTFE (teflón). Bidireccional.

Código en FKM termina en "F"
en lugar de "E"

**VKDDV**

d	Ref. EPDM	DN	PN	€ EPDM	€ FKM
75	VKDDV075E	65	16	366,31	438,50
90	VKDDV090E	80	16	466,71	554,75
110	VKDDV110E	100	16	524,83	646,31

Válvula de bola DUAL BLOCK®.
M-M encolar. Asiento PTFE (teflón).
Bidireccional.

Código en FKM termina en "F"
en lugar de "E"

**VKDBEV**

d	Ref. EPDM	DN	PN	€ EPDM	€ FKM
75	VKDBEV075E	65	16	402,95	475,17
90	VKDBEV090E	80	16	513,38	601,43
110	VKDBEV110E	100	16	577,29	698,80

Válvula de bola DUAL BLOCK®.
Long spigot PE100 SDR11.
Asiento PTFE (teflón). Bidireccional.

Código en FKM termina en "F"
en lugar de "E"

**VKROV**

d	Ref. EPDM	DN	PN	€ EPDM	€ FKM
20	VKROV020E	15	16	197,54	197,54
25	VKROV025E	20	16	222,04	222,04
32	VKROV032E	25	16	261,91	261,91
40	VKROV040E	32	16	288,34	288,34
50	VKROV050E	40	16	365,86	365,86
63	VKROV063E	50	16	399,05	399,05

Válvula de bola REGULACIÓN
DUALBLOCK®.
Con bridas DIN 2501.

Asiento PTFE (teflón). Bidireccional.

Código en FKM termina en "F"
en lugar de "E"

**VKROAV**

d	Ref. EPDM	DN	PN	€ EPDM	€ FKM
½"	VKROAV012E	15	16	197,54	197,54
¾"	VKROAV034E	20	16	222,04	222,04
1"	VKROAV100E	25	16	261,91	261,91
1¼"	VKROAV114E	32	16	288,34	288,34
1½"	VKROAV112E	40	16	365,86	365,86
2"	VKROAV200E	50	16	399,05	399,05

Válvula de bola REGULACIÓN
DUALBLOCK®.
Con bridas ANSI 150 lbs.

Asiento PTFE (teflón). Bidireccional.

Código en FKM termina en "F"
en lugar de "E"

Para recambios de las válvulas consultar el último apartado "Recambios" de esta misma tarifa.



VKDOV

d	Ref. EPDM	DN	PN	€ EPDM	€ FKM
20	VKDOV020E	15	16	117,62	122,01
25	VKDOV025E	20	16	137,88	142,95
32	VKDOV032E	25	16	194,03	153,92
40	VKDOV040E	32	16	182,53	190,47
50	VKDOV050E	40	16	202,80	219,40
63	VKDOV063E	50	16	234,18	258,21

Válvula de bola DUAL BLOCK®.
Con brida loca. Asiento PTFE (teflón).
Bidireccional.

Código en FKM termina en "F"
en lugar de "E"
Versión con bridas ANSI 150 lbs
al mismo precio



VKRIV

d	Ref. EPDM	DN	PN	€ EPDM	€ FKM
16	VKRIV016E	10	16	161,79	170,21
20	VKRIV020E	15	16	163,41	171,51
25	VKRIV025E	20	16	183,57	193,95
32	VKRIV032E	25	16	220,40	233,08
40	VKRIV040E	32	16	232,77	246,63
50	VKRIV050E	40	16	304,66	321,95
63	VKRIV063E	50	16	317,30	351,48

Válvula de bola REGULACIÓN
DUALBLOCK®.

H-H encolar. Asiento PTFE (teflón).
Bidireccional.

Código en FKM termina en "F"
en lugar de "E"



VKDOV

d	Ref. EPDM	DN	PN	€ EPDM	€ FKM
75	VKDOV075E	65	16	558,31	599,21
90	VKDOV090E	80	16	702,96	777,87
110	VKDOV110E	100	16	884,13	980,45

Válvula de bola DUAL BLOCK®.
Con brida loca. Asiento PTFE (teflón).
Bidireccional. DIN y ANSI 150 Lbs.

Código en FKM termina en "F"
en lugar de "E"



VKRFV

Rh	Ref. EPDM	DN	PN	€ EPDM	€ FKM
3/8"	VKRFV038E	10	16	164,92	164,92
1/2"	VKRFV012E	15	16	166,94	166,94
3/4"	VKRFV034E	20	16	188,36	188,36
1"	VKRFV100E	25	16	225,37	225,37
1 1/4"	VKRFV114E	32	16	240,72	240,72
1 1/2"	VKRFV112E	40	16	316,67	316,67
2"	VKRFV200E	50	16	333,86	333,88

Válvula de bola REGULACIÓN
DUALBLOCK®.

H-H roscar. Asiento PTFE (teflón).
Bidireccional.

Código en FKM termina en "F"
en lugar de "E"



VKRDV

d	Ref. EPDM	DN	PN	€ EPDM	€ FKM
16	VKRDV016E	10	16	161,79	161,79
20	VKRDV020E	15	16	163,41	163,41
25	VKRDV025E	20	16	183,57	183,57
32	VKRDV032E	25	16	220,40	220,40
40	VKRDV040E	32	16	232,77	232,77
50	VKRDV050E	40	16	304,66	304,66
63	VKRDV063E	50	16	317,30	317,30

Válvula de bola REGULACIÓN
DUALBLOCK®.

M-M encolar. Asiento PTFE (teflón).
Bidireccional.

Código en FKM termina en "F"
en lugar de "E"



VKRBEV

d	Ref. EPDM	DN	PN	€ EPDM	€ FKM
20	VKRBEV020E	15	16	171,96	171,96
25	VKRBEV025E	20	16	184,80	184,80
32	VKRBEV032E	25	16	217,34	217,34
40	VKRBEV040E	32	16	231,93	231,93
50	VKRBEV050E	40	16	299,43	299,43
63	VKRBEV063E	50	16	317,07	317,07

Válvula de bola REGULACIÓN
DUALBLOCK®.

Long spigot PE100 SDR11.
Asiento PTFE (teflón). Bidireccional.

Código en FKM termina en "F"
en lugar de "E"

Para recambios de las válvulas consultar el último apartado "Recambios" de esta misma tarifa.



INDUSTRIA

Válvulas manuales de PVC-U presión

Válvulas de bola de 3 vías



TKDIV

d	Ref. EPDM	DN	PN	€ EPDM	€ FKM
16	TKDIV016E	10	16	121,06	136,86
20	TKDIV020E	15	16	123,60	139,66
25	TKDIV025E	20	16	143,03	164,51
32	TKDIV032E	25	16	177,30	203,92
40	TKDIV040E	32	16	213,86	252,46
50	TKDIV050E	40	16	258,51	323,07
63	TKDIV063E	50	16	326,13	407,68

Válvula de bola 3 vías
DUAL BLOCK®. PASO T.

H-H-H encolar. Asiento PTFE (teflón).

Código en FKM termina en "F"
en lugar de "E"



LKDIV

d	Ref. EPDM	DN	PN	€ EPDM	€ FKM
16	LKDIV016E	10	16	133,17	150,51
20	LKDIV020E	15	16	135,93	153,60
25	LKDIV025E	20	16	157,40	180,93
32	LKDIV032E	25	16	195,09	224,32
40	LKDIV040E	32	16	235,35	277,73
50	LKDIV050E	40	16	284,31	355,38
63	LKDIV063E	50	16	358,75	448,43

Válvula de bola 3 vías
DUAL BLOCK®. PASO L.

H-H-H encolar. Asiento PTFE (teflón).

Código en FKM termina en "F"
en lugar de "E"



TKDFV

Rh	Ref. EPDM	DN	PN	€ EPDM	€ FKM
3/8"	TKDFV038E	10	16	133,17	148,95
1/2"	TKDFV012E	15	16	135,93	152,01
3/4"	TKDFV034E	20	16	157,40	178,79
1"	TKDFV100E	25	16	195,09	221,63
1 1/4"	TKDFV114E	32	16	235,35	273,86
1 1/2"	TKDFV112E	40	16	284,31	348,99
2"	TKDFV200E	50	16	358,75	440,32

Válvula de bola 3 vías
DUAL BLOCK®. PASO T.

H-H-H roscar. Asiento PTFE (teflón).

Código en FKM termina en "F"
en lugar de "E"



LKDFV

Rh	Ref. EPDM	DN	PN	€ EPDM	€ FKM
3/8"	LKDFV038E	10	16	145,34	162,65
1/2"	LKDFV012E	15	16	148,29	165,97
3/4"	LKDFV034E	20	16	171,63	195,21
1"	LKDFV100E	25	16	212,76	242,03
1 1/4"	LKDFV114E	32	16	256,72	299,13
1 1/2"	LKDFV112E	40	16	310,18	381,25
2"	LKDFV200E	50	16	391,39	481,05

Válvula de bola 3 vías
DUAL BLOCK®. PASO L.

H-H-H roscar. Asiento PTFE (teflón).

Código en FKM termina en "F"
en lugar de "E"



TKDDV

d	Ref. EPDM	DN	PN	€ EPDM	€ FKM
20	TKDDV020E	15	16	123,60	139,66
25	TKDDV025E	20	16	143,03	164,51
32	TKDDV032E	25	16	177,30	203,92
40	TKDDV040E	32	16	213,86	252,46
50	TKDDV050E	40	16	258,51	223,07
63	TKDDV063E	50	16	326,13	407,68

Válvula de bola 3 vías
DUAL BLOCK®. PASO T.

M-M-M encolar. Asiento PTFE (teflón).

Código en FKM termina en "F"
en lugar de "E"

Para recambios de las válvulas consultar el último apartado "Recambios" de esta misma tarifa.



INDUSTRIA

Válvulas manuales de PVC-U presión

Válvulas de 3 vías / Válvulas de mariposa



LKDDV

d	Ref. EPDM	DN	PN	€ EPDM	€ FKM
20	LKDDV020E	15	16	135,93	153,60
25	LKDDV025E	20	16	157,40	180,93
32	LKDDV032E	25	16	195,09	224,32
40	LKDDV040E	32	16	235,35	277,73
50	LKDDV050E	40	16	284,31	355,38
63	LKDDV063E	50	16	358,75	448,43

Válvula de bola 3 vías
DUAL BLOCK®. PASO L.

M-M-M encolar. Asiento PTFE (teflón).

Código en FKM termina en "F"
en lugar de "E"



SETFLOV

d DIN	d ANSI	Ref. DIN	€ DIN 2501	€ ANSI
20	½"	SETFLOV020	59,97	59,97
25	¾"	SETFLOV025	72,05	72,05
32	1"	SETFLOV032	77,07	77,07
40	1¼"	SETFLOV040	92,45	92,45
50	1½"	SETFLOV050	105,53	105,53
63	2"	SETFLOV063	114,32	114,32
75	2½"	SETFLOV075	210,27	210,27
90	3"	SETFLOV090	246,63	246,63
110	4"	SETFLOV110	297,55	297,55

Set embrizado.

Compuesto por 1 brida, 1 anillo fijación y 1 tuerca.
Para Válvulas VKD / VKR / TKD / RVU / VRU / VVU.

d. 75-90-110,
es el mismo artículo
para DIN y ANSI



FEOV/LM

d	Ref. EPDM	DN	€ EPDM	€ FKM
50	FEOVLM050E	40	133,65	245,37
63	FEOVLM063E	50	140,19	258,93
75	FEOVLM075E	65	145,34	262,06
90	FEOVLM090E	80	163,38	317,56
110	FEOVLM110E	100	187,97	389,04
125 (A1)	FEOVLM140E	125	216,47	508,23
140	FEOVLM140E	125	216,47	508,23
160	FEOVLM160E	150	266,43	730,50
200 (A1)	FEOVLM225E	200	428,63	1.029,47
225	FEOVLM225E	200	428,63	1.029,47
(B) 250 (1)	FEOVFM280E	250	1.270,87	-
280 (1)	FEOVFM280E	250	1.270,87	-
315 (1)	FEOVFM315E	300	1.579,64	-

Válvula de mariposa
"WAFER".
Con maneta.

Código en FKM termina en "F"
en lugar de "E"

(A1) A utilizar con portabridas especial
QPV FK/FE no incluido. (1) Sin maneta
(B) A utilizar con tubo D250 SDR26 (PN10)



FEOV/RM

d	Ref. EPDM	DN	€ EPDM	€ FKM
75	FEOVRM075E	65	408,03	491,98
90	FEOVRM090E	80	424,47	531,27
110	FEOVRM110E	100	439,12	587,86
125 (A1)	FEOVRM140E	125	459,18	676,36
140	FEOVRM140E	125	459,18	676,36
160	FEOVRM160E	150	495,62	846,15
200 (A1)	FEOVRM225E	200	719,25	1.196,64
225	FEOVRM225E	200	719,25	1.196,64
250	FEOVRM280E	250	1.784,85	-
280	FEOVRM280E	250	1.784,85	-
315	FEOVRM315E	300	2.007,31	-

Válvula de mariposa
"WAFER".

Con volante reductor.

Código en FKM termina en "F"
en lugar de "E"

(A1) A utilizar con portabridas especial
QPV FK/FE no incluido.

Ver portabridas especial QPV FK/FE para válvulas de mariposa en el apartado
Accesorios de PVC-U de esta misma tarifa.

Para recambios de las válvulas consultar el último apartado "Recambios" de esta misma tarifa.



FKOV/FM

d	Ref. EPDM	DN	€ EPDM	€ FKM
50	FKOVFM050E	40	299,28	467,61
63	FKOVFM063E	50	316,88	495,17
75	FKOVFM075E	65	352,11	550,12
90	FKOVFM090E	80	382,95	589,74
110	FKOVFM110E	100	415,14	638,15
125 (A1)	FKOVFM140E	125	551,61	853,84
140	FKOVFM140E	125	551,61	853,84
160	FKOVFM160E	150	610,28	922,76
200 (A1)	FKOVFM225E	200	789,27	1.197,09
225	FKOVFM225E	200	789,27	1.197,09
250**	FKOVFM280E	250	2.516,31	4.227,01
280**	FKOVFM280E	250	2.516,31	4.227,01
315**	FKOVFM315E	300	2.743,67	4.608,49
355**	FKOVFM355E	350	4.654,03	8.535,09
400**	FKOVFM400E	400	5.297,65	10.904,22

Válvula de mariposa industrial.

A EJE LIBRE.

Para actuar. Cuerpo en PPGR,
eje inoxidable y disco en PVC-U.

Código en FKM termina en "F"
en lugar de "E"

(A1) A utilizar con portabridas especial
QPV FK/FE no incluido.

** ANSI 150 lbs bajo pedido
al mismo precio.



FKOV/LM

d	Ref. EPDM	DN	€ EPDM	€ FKM
50	FKOVLM050E	40	351,67	519,99
63	FKOVLM063E	50	372,33	550,57
75	FKOVLM075E	65	413,67	611,77
90	FKOVLM090E	80	434,20	641,06
110	FKOVLM110E	100	472,39	693,89
125 (A1)	FKOVLM140E	125	627,85	928,62
140	FKOVLM140E	125	627,85	928,62
160	FKOVLM160E	150	677,78	971,17
200 (A1)	FKOVLM225E	200	877,28	1.260,20
225	FKOVLM225E	200	877,28	1.260,20

Válvula de mariposa industrial.

CON MANETA.

Cuerpo en PPGR,
eje inoxidable y disco en PVC-U.

Código en FKM termina en "F"
en lugar de "E"

(A1) A utilizar con portabridas especial
QPV FK/FE no incluido.



FKOV/RM

d	Ref. EPDM	DN	€ EPDM	€ FKM
75	FKOVRM075E	65	1.003,45	1.201,48
90	FKOVRM090E	80	1.025,42	1.232,24
110	FKOVRM110E	100	1.062,11	1.283,63
125 (A1)	FKOVRM140E	125	1.217,65	1.518,33
140	FKOVRM140E	125	1.217,65	1.518,33
160	FKOVRM160E	150	1.267,49	1.560,94
200 (A1)	FKOVRM225E	200	1.600,53	1.983,45
225	FKOVRM225E	200	1.600,53	1.983,45
250**(B)	FKOVRM280E	250	2.935,90	4.631,95
6"	FKOVRM280E	250	2.935,90	4.631,95
8"	FKOVRM315E	300	3.163,34	5.026,66
10"	FKOVRM355E	350	5.735,78	9.616,90
12"	FKOVRM400E	400	6.379,37	11.985,94

Válvula de mariposa industrial.

CON VOLANTE.

Cuerpo en PPGR,
eje inoxidable y disco
en PVC-U.

Código en FKM termina en "F"
en lugar de "E"

(A) A utilizar con portabridas especial
QPV FK/FE no incluido.

(B) A utilizar con tubo D250 SDR26 (PN10)
** ANSI 150 lbs bajo pedido al mismo precio



FKOV/FM

d	Ref. EPDM	DN	€ EPDM	€ FKM
75	FKOLVFM075E	65	534,01	732,02
90	FKOLVFM090E	80	620,55	827,43
110	FKOLVFM110E	100	673,35	896,40
125 (A1)	FKOLVFM140E	125	896,40	1.198,55
140	FKOLVFM140E	125	896,40	1.198,55
160	FKOLVFM160E	150	982,94	1.295,43
200 (A1)	FKOLVFM225E	200	1.175,09	1.582,89
225	FKOLVFM225E	200	1.175,09	1.582,89

Válvula de mariposa industrial.

A EJE LIBRE. LUG ISO-DIN.

Para actuar. Cuerpo en PPGR,
eje inoxidable y disco en PVC-U.

Código en FKM termina en "F"
en lugar de "E"

Para recambios de las válvulas consultar el último apartado "Recambios" de esta misma tarifa.



FKOV/LM

d	Ref. EPDM	DN	€ EPDM	€ FKM
75	FKOLVLM075E	65	595,58	793,66
90	FKOLVLM090E	80	671,89	878,74
110	FKOLVLM110E	100	730,55	952,11
125 (A1)	FKOLVLM140E	125	972,61	1.273,33
140	FKOLVLM140E	125	972,61	1.273,33
160	FKOLVLM160E	150	1.050,42	1.343,79
200 (A1)	FKOLVLM225E	200	1.263,05	1.645,99
225	FKOLVLM225E	200	1.263,05	1.645,99

Válvula de mariposa industrial.
CON MANETA. LUG ISO-DIN.
 Cuerpo en PPGR,
 eje inoxidable y disco en PVC-U.

Código en FKM termina en "F"
 en lugar de "E"
 (A1) A utilizar con portabridas
 especial QPV FK/FE no incluido.



FKOV/RM

d	Ref. EPDM	DN	€ EPDM	€ FKM
75	FKOLVRM075E	65	1.185,39	1.383,41
90	FKOLVRM090E	80	1.263,05	1.469,90
110	FKOLVRM110E	100	1.320,27	1.541,82
125 (A1)	FKOLVRM140E	125	1.562,41	1.863,07
140	FKOLVRM140E	125	1.562,41	1.863,07
160	FKOLVRM160E	150	1.640,13	1.933,50
200 (A1)	FKOLVRM225E	200	1.986,31	2.369,25
225	FKOLVRM225E	200	1.986,31	2.369,25

Válvula de mariposa industrial.
CON VOLANTE. LUG ISO-DIN.
 Cuerpo en PPGR,
 eje inoxidable y disco en PVC-U.

Código en FKM termina en "F"
 en lugar de "E"
 (A1) A utilizar con portabridas
 especial QPV FK/FE no incluido.



FKOV/FM

d	Ref. EPDM	DN	€ EPDM	€ FKM
2½"	FKOALVFM212E	65	624,92	822,96
3"	FKOALVFM300E	80	715,91	922,76
4"	FKOALVFM400E	100	777,53	1.000,47
5"	FKOALVFM500E	125	1.034,25	1.336,47
6"	FKOALVFM600E	150	1.132,54	1.445,05
8"	FKOALVFM800E	200	1.367,22	1.775,03
10"	FKOALVFM810E	250	4.365,83	6.076,59
12"	FKOALVFM812E	300	4.635,67	6.500,51

Válvula de mariposa industrial.
A EJE LIBRE. LUG ANSI.
 Para actuar. Cuerpo en PPGR,
 eje inoxidable y disco en PVC-U.

Código en FKM termina en "F"
 en lugar de "E"



FKOV/LM

d	Ref. EPDM	DN	€ EPDM	€ FKM
2½"	FKOALVLM212E	65	686,56	884,61
3"	FKOALVLM300E	80	767,25	974,05
4"	FKOALVLM400E	100	834,75	1.056,22
5"	FKOALVLM500E	125	1.110,51	1.411,29
6"	FKOALVLM600E	150	1.199,97	1.493,43
8"	FKOALVLM800E	200	1.455,20	1.838,14

Válvula de mariposa industrial.
CON MANETA. LUG ANSI.
 Cuerpo en PPGR,
 eje inoxidable y disco en PVC-U.

Código en FKM termina en "F"
 en lugar de "E"



FKOV/RM

d	Ref. EPDM	DN	€ EPDM	€ FKM
2½"	FKOALVRM212E	65	1.276,31	1.474,35
3"	FKOALVRM300E	80	1.358,41	1.565,28
4"	FKOALVRM400E	100	1.424,42	1.645,99
5"	FKOALVRM500E	125	1.700,26	2.001,03
6"	FKOALVRM600E	150	1.789,78	2.083,16
8"	FKOALVRM800E	200	2.178,43	2.561,35
10"	FKOALVRM810E	250	4.785,52	6.481,58
12"	FKOALVRM812E	300	5.055,25	6.918,61

Válvula de mariposa industrial.
CON VOLANTE. LUG ANSI.
 Cuerpo en PPGR,
 eje inoxidable y disco en PVC-U.

Código en FKM termina en "F"
 en lugar de "E"

Para recambios de las válvulas consultar el último apartado "Recambios" de esta misma tarifa.



Válvulas manuales de PVC-U presión

Válvulas y grifos de membrana



DKDV

d	Ref. EPDM	DN	€ EPDM	€ FKM	€ PTFE
20	DKDV020E	15	97,29	172,59	202,04
25	DKDV025E	20	108,33	181,79	211,11
32	DKDV032E	25	132,23	207,48	238,76
40	DKDV040E	32	156,09	284,55	317,64
50	DKDV050E	40	214,93	341,49	374,57
63	DKDV063E	50	262,48	475,55	469,90
75	DKDV075E	65	315,00	570,65	563,91

Válvula de membrana
DIALOCK®.
M-M encolar.

Código en FKM termina en "F"
en lugar de "E"
Código en PTFE termina en "P"
en lugar de "E"



DKLDV

d	Ref. EPDM	DN	€ EPDM	€ FKM	€ PTFE
20	DKLDV020E	15	244,07	319,34	348,81
25	DKLDV025E	20	255,13	328,57	357,87
32	DKLDV032E	25	279,01	354,23	385,53
40	DKLDV040E	32	302,84	431,28	464,39
50	DKLDV050E	40	403,60	530,17	546,87
63	DKLDV063E	50	451,21	664,23	639,44
75	DKLDV075E	65	541,41	797,09	767,33

Válvula de membrana
DIALOCK®. **CON LIMITADOR
DE CARRERA.**
M-M encolar.

Código en FKM termina en "F"
en lugar de "E"
Código en PTFE termina en "P"
en lugar de "E"



VMDV

d	Ref. EPDM	DN	€ EPDM	€ FKM	€ PTFE
90	VMDV090E	80	752,79	1.345,75	1.033,55
110	VMDV110E	100	1.044,58	2.050,80	1.391,65

Válvula de membrana.
M-M encolar.

Código en FKM termina en "F"
en lugar de "E"
Código en PTFE termina en "P"
en lugar de "E"



DKUIV

d	Ref. EPDM	DN	€ EPDM	€ FKM	€ PTFE
20	DKUIV020E	15	117,57	196,41	234,97
25	DKUIV025E	20	128,60	216,71	253,43
32	DKUIV032E	25	159,80	249,80	284,55
40	DKUIV040E	32	190,97	334,09	374,57
50	DKUIV050E	40	260,65	413,13	453,48
63	DKUIV063E	50	321,22	563,59	556,22

Válvula de membrana
DIALOCK®.
Con enlaces H-H para encolar.

Código en FKM termina en "F"
en lugar de "E"
Código en PTFE termina en "P"
en lugar de "E"



DKLUIV

d	Ref. EPDM	DN	€ EPDM	€ FKM	€ PTFE
20	DKLUIV020E	15	264,31	343,17	381,75
25	DKLUIV025E	20	275,37	363,44	400,18
32	DKLUIV032E	25	306,52	396,57	431,31
40	DKLUIV040E	32	337,75	480,87	521,32
50	DKLUIV050E	40	449,32	601,83	642,18
63	DKLUIV063E	50	509,92	752,26	744,92

Válvula de membrana
DIALOCK®. **CON LIMITADOR
DE CARRERA.**
Con enlaces H-H para encolar.

Código en FKM termina en "F"
en lugar de "E"
Código en PTFE termina en "P"
en lugar de "E"



DKUFV

Rh	Ref. EPDM	DN	PN	€ EPDM	€ FKM	€ PTFE
½"	DKUFV012E	15	10	128,60	207,48	246,00
¾"	DKUFV034E	20	10	139,47	229,53	264,41
1"	DKUFV100E	25	10	170,73	258,85	295,57
1¼"	DKUFV114E	32	10	225,76	368,97	407,53
1½"	DKUFV120E	40	10	230,29	345,32	377,66
2"	DKUFV200E	50	10	359,77	602,17	592,94

Válvula de membrana
DIALOCK®.
Con enlaces H-H para rosacar.

Código en FKM termina en "F"
en lugar de "E"
Código en PTFE termina en "P"
en lugar de "E"

Para recambios de las válvulas consultar el último apartado "Recambios" de esta misma tarifa.



DKOV

d	Ref. EPDM	DN	PN	€ EPDM	€ FKM	€ PTFE
20	DKOV020E	15	10	161,01	236,27	265,70
25	DKOV025E	20	10	175,17	248,65	277,96
32	DKOV032E	25	10	201,88	277,12	308,33
40	DKOV040E	32	10	248,80	377,27	410,38
50	DKOV050E	40	10	312,15	438,73	471,81
63	DKOV063E	50	10	398,69	611,77	606,17
75	DKOV075E	65	10	518,31	795,33	788,04

Válvula de membrana
DIALOCK®.

Con bridas DIN.

Código en FKM termina en "F"
en lugar de "E"

Código en PTFE termina en "P"
en lugar de "E"

* DIN y ANSI 150lbs.



DKOAV

d	Ref. EPDM	DN	PN	€ EPDM	€ FKM	€ PTFE
½"	DKOAV012E	15	10	161,01	236,27	265,70
¾"	DKOAV034E	20	10	175,17	248,65	277,96
1"	DKOAV100E	25	10	201,88	277,12	308,33
1¼"	DKOAV114E	32	10	248,80	377,27	410,38
1½"	DKOAV120E	40	10	238,70	335,49	360,80
2"	DKOAV200E	50	10	398,69	611,77	606,17
2½"	DKOAV212E	65	10	518,31	795,33	788,04

Válvula de membrana
DIALOCK®.

Con bridas ANSI 150 lbs.

Código en FKM termina en "F"
en lugar de "E"

Código en PTFE termina en "P"
en lugar de "E"



VMOV

d	Ref. EPDM	DN	€ EPDM	€ FKM	€ PTFE
90	VMOV090E	80	1.023,16	1.616,15	1.304,01
110	VMOV110E	100	1.361,00	2.367,21	1.708,11

Válvula de membrana
Con bridas DIN.

Bajo pedido con bridas ANSI 150 lbs.
(con el mismo precio)

Código en FKM termina en "F"
en lugar de "E"

Código en PTFE termina en "P"
en lugar de "E"

CMDV

M-M encolar.

CMIV

H-H encolar.

CMUIV

H-H enlaces
encolar

CMFV

H-H roscar.



d-Rh	Ref. EPDM	DN	€ EPDM	€ FKM	€ FKM
20	CMDV020E	15	95,54	135,81	143,25
16	CMIV016E	12	78,91	110,16	124,83
20	CMIV020E	15	100,95	124,83	134,04
20	CMUIV020E	15	110,16	141,41	146,88
¾"	CMFV038E	12	78,91	110,16	124,83
½"	CMFV012E	15	100,95	124,83	134,04

Válvula de membrana
compacta.

Código en FKM termina en "F"
en lugar de "E"

Código en PTFE termina en "P"
en lugar de "E"



RPDRV

Rm-d	Ref.	DN	U/⊠	€ FKM
½"-16	RPDRV012016F	15	50	51,53

Grifo de pistón hidroponía.

Membrana en FKM. M espiga - M roscar.



RMRPV

Rm-Pm	Ref.	DN	€ EPDM
½"-20	RMRPV012020E	15	36,47

Grifo de membrana.

Membrana en EPDM. M espiga - M roscar.



VMFV

Rh	Ref.	DN	U/⊠	€ EPDM
¼"	VMFV014E	8	1	51,26

Grifo de membrana.

Membrana en EPDM. H-H roscar.



RMRV

Rm	Ref.	DN	U/⊠	€ EPDM
½"	RMRV012E	15	1	36,47

Grifo de membrana.

Membrana en EPDM. M-M roscar.

Para recambios de las válvulas consultar el último apartado "Recambios" de esta misma tarifa.

**VMIV**

d	Ref.	DN	U/	€ EPDM
12	VMIV012E	8	1	48,14

Grifo de membrana.

Membrana en EPDM. H-H

**VVUIV**

d	Ref.	DN	PN	U/	€ EPDM
16	VVUIV016E	10	16	6	67,87
20	VVUIV020E	15	16	6	69,33
25	VVUIV025E	20	16	6	79,38
32	VVUIV032E	25	16	6	94,49
40	VVUIV040E	32	10	16	124,44
50	VVUIV050E	40	10	16	166,18
63	VVUIV063E	50	10	16	248,85

Válvula asiento inclinado.

Junta EPDM. H-H enlaces para encolar.

**VVDV**

d	Ref.	DN	PN	U/	€ EPDM
16	VVDV016E	10	16	6	59,29
20	VVDV020E	15	16	6	62,37
25	VVDV025E	20	16	6	68,99
32	VVDV032E	25	16	6	82,15
40	VVDV040E	32	10	16	108,25
50	VVDV050E	40	10	16	144,50
63	VVDV063E	50	10	16	209,99

Válvula asiento inclinado.

Junta EPDM. M-M encolar.

Para recambios de las válvulas consultar el último apartado "Recambios" de esta misma tarifa.



INDUSTRIA

Válvulas manuales de PVC-U presión

Válvulas de retención

**SXEIV**

d	Ref. EPDM	DN	PN	Pack	U/	€ EPDM	€ FKM
16	SXEIV016E	10	16	2	30	31,10	32,91
20	SXEIV020E	15	16	2	30	31,25	33,03
25	SXEIV025E	20	16	2	30	36,09	36,85
32	SXEIV032E	25	16	2	20	38,31	40,01
40	SXEIV040E	32	16	2	14	47,71	53,83
50	SXEIV050E	40	16	2	6	58,69	62,82
63	SXEIV063E	50	16	2	6	85,26	100,14
75	SXEIV075E	65	16	2	2	196,57	210,33
90	SXEIV090E	80	16	2	2	246,57	262,35
110	SXEIV110E	100	16	2	2	323,57	356,95

Válvula de bola anti-retorno.

Juntas en EPDM o FKM. H-H encolar.

Código en FKM termina en "F" en lugar de "E"

**SXEIV**

Rh	Ref. EPDM	DN	PN	Pack	U/	€ EPDM	€ FKM
3/8"	SXEIV038E	10	16	2	30	33,51	Consultar
1/2"	SXEIV012E	15	16	2	30	33,61	Consultar
3/4"	SXEIV034E	20	16	2	30	39,70	Consultar
1"	SXEIV100E	25	16	2	20	44,01	Consultar
1 1/4"	SXEIV114E	32	16	2	14	52,91	Consultar
1 1/2"	SXEIV112E	40	16	2	6	64,05	Consultar
2"	SXEIV200E	50	16	2	6	100,90	Consultar
2 1/2"	SXEIV212E	65	16	2	2	223,95	237,71
3"	SXEIV300E	80	16	2	2	280,27	296,07
4"	SXEIV400E	100	16	2	2	340,91	374,29

Válvula de bola anti-retorno.

Juntas en EPDM o FKM. H-H roscar.

* Consultar

Código en FKM termina en "F" en lugar de "E"

**SXEBEV**

d	Ref. EPDM	DN	PN	U/	€ EPDM	€ FKM
75	SXEBEV075E	65	16	1	229,97	239,78
90	SXEBEV090E	80	16	1	288,51	299,07
110	SXEBEV110E	100	16	1	378,60	406,93

Válvula de bola anti-retorno.

Junta EPDM o FKM.

Long spigot PE100 SDR11.

Código en FKM termina en "F" en lugar de "E"

**VZIV**

d-Rh	Ref. EPDM	DN	PN	U/	€ EPDM
16-3/8"	VZIV016E	10	16	16	54,56
20-1/2"	VZIV020E	15	16	16	55,92
25-3/4"	VZIV025E	20	16	16	63,19
32-1"	VZIV032E	25	16	6	68,19
40-1 1/4"	VZIV040E	32	16	3	76,87
50-1 1/2"	VZIV050E	40	16	3	106,65
63-2"	VZIV063E	50	16	3	152,03

Válvula de fondo / pie.

Juntas en EPDM.

H-M encolar - H-H roscar.

Se suministra con las piezas necesarias para convertir la válvula roscada hembra por ambos extremos.

**SXE SSE**

d	Ref. EPDM	DN	€
16-20	HAVXE020	10-15	4,11
25	HAVXE025	20	6,05
32	HAVXE032	25	8,76
40	HAVXE040	32	17,24
50	HAVXE050	40	17,55
63	HAVXE063	50	28,11

Maneta multifunción EASYFIT

Para apretar tuercas de válvulas

SXE - SSE.

Para recambios de las válvulas consultar el último apartado "Recambios" de esta misma tarifa.

**SSEIV**

d	Ref. EPDM	DN	PN	Pack	U/	€ EPDM	€ FKM
16	SSEIV016E	10	16	2	30	27,22	28,83
20	SSEIV020E	15	16	2	30	27,36	28,93
25	SSEIV025E	20	16	2	30	31,65	32,30
32	SSEIV032E	25	16	2	20	33,58	35,07
40	SSEIV040E	32	16	2	14	41,82	47,21
50	SSEIV050E	40	16	2	6	51,47	55,08
63	SSEIV063E	50	16	2	6	74,73	87,77
75	SSEIV075E	65	16	-	1	172,28	184,30
90	SSEIV090E	80	16	-	1	216,14	229,92
110	SSEIV110E	100	16	-	1	283,61	312,80

Válvula de retención
con muelle en INOX 316.

Juntas en EPDM o FKM. H-H encolar.

Código en FKM termina en "F"
en lugar de "E"

**SSEFV**

Rh	Ref. EPDM	DN	PN	Pack	U/	€ EPDM	€ FKM
3/8"	SSEFV038E	10	16	2	30	29,35	30,94
1/2"	SSEFV012E	15	16	2	30	29,48	31,05
3/4"	SSEFV034E	20	16	2	30	34,78	35,49
1"	SSEFV100E	25	16	2	20	38,58	40,10
1 1/4"	SSEFV114E	32	16	2	14	46,37	51,73
1 1/2"	SSEFV112E	40	16	2	6	56,13	59,73
2"	SSEFV200E	50	16	2	6	88,42	101,48
2 1/2"	SSEFV212E	65	16	-	1	196,29	208,35
3"	SSEFV300E	80	16	-	1	245,67	259,47
4"	SSEFV400E	100	16	-	1	298,78	328,02

Válvula de retención
con muelle en INOX 316.

Juntas en EPDM o FKM. H-H roscar.

Código en FKM termina en "F"
en lugar de "E"

**SSEIV**

d	Ref. EPDM	DN	PN	Pack	U/	€ EPDM	€ FKM
16	SSEIV016EH	10	16	2	30	81,39	82,99
20	SSEIV020EH	15	16	2	30	81,52	83,07
25	SSEIV025EH	20	16	2	30	88,61	89,29
32	SSEIV032EH	25	16	2	20	87,25	88,74

Válvula de retención
con muelle en HASTELLOY.

Juntas en EPDM o FKM. H-H encolar.

Código en FKM termina en "FH"
en lugar de "EH"

**SSEFV**

Rh	Ref. EPDM	DN	PN	Pack	U/	€ EPDM	€ FKM
3/8"	SSEFV038EH	10	16	2	30	83,74	85,36
1/2"	SSEFV012EH	15	16	2	30	83,96	85,47
3/4"	SSEFV034EH	20	16	2	30	92,22	92,92
1"	SSEFV100EH	25	16	2	20	92,92	94,41

Válvula de retención
con muelle en HASTELLOY.

Juntas en EPDM o FKM. H-H roscar.

Código en FKM termina en "FH"
en lugar de "EH"

**SSEIV**

d	Ref. EPDM	DN	PN	Pack	U/	€ EPDM	€ FKM
40	SSEIV040E0P	32	16	2	14	59,03	64,39
50	SSEIV050E0P	40	16	2	6	69,59	73,17
63	SSEIV063E0P	50	16	2	6	99,39	112,41
75	SSEIV075E0P	65	16	-	1	218,98	218,98
90	SSEIV090E0P	80	16	-	1	266,07	269,65
110	SSEIV110E0P	100	16	-	1	348,63	348,63

Válvula de retención
con muelle en INOX
recubierto de PTFE.

Juntas en EPDM o FKM. H-H encolar.

Código en FKM termina en "F0P"
en lugar de "E0P"

**SSEFV**

Rh	Ref. EPDM	DN	PN	Pack	U/	€ EPDM	€ FKM
1 1/4"	SSEFV114E0P	32	16	2	14	64,21	69,63
1 1/2"	SSEFV112E0P	40	16	2	6	74,91	78,51
2"	SSEFV200E0P	50	16	2	6	115,03	128,07
2 1/2"	SSEFV212E0P	65	16	1	1	246,39	246,39
3"	SSEFV300E0P	80	16	1	1	303,33	303,33
4"	SSEFV400E0P	100	16	-	1	365,97	365,97

Válvula de retención
con muelle en INOX
recubierto de PTFE.

Juntas en EPDM o FKM. H-H roscar.

Código en FKM termina en "F0P"
en lugar de "E0P"

Para recambios de las válvulas consultar el último apartado "Recambios" de esta misma tarifa.

**SSEBEV**

d	Ref. EPDM	DN	PN	Pack	U/	€ EPDM	€ FKM
75	SSEBEV075E	65	16	-	1	201,54	210,15
90	SSEBEV090E	80	16	-	1	252,86	262,09
110	SSEBEV110E	100	16	-	1	331,77	356,58

Válvula de retención
con muelle en INOX 316.

Juntas en EPDM o FKM.
Long spigot PE100 SDR11.

Código en FKM termina en "F"
en lugar de "E"

**SSEBEV**

d	Ref. EPDM	DN	PN	Pack	U/	€ EPDM	€ FKM
75	SSEBEV075E0P	65	16	-	1	249,95	249,67
90	SSEBEV090E0P	80	16	-	1	311,25	307,36
110	SSEBEV110E0P	100	16	-	1	392,62	397,43

Válvula de retención con muelle
en INOX recubierto PTFE.

Juntas en EPDM o FKM.
Long spigot PE100 SDR11.

Código en FKM termina en "F0P"
en lugar de "E0P"

**VRUIV**

d	Ref. EPDM	DN	U/	€ EPDM	€ FKM
16	VRUIV016E	10	20	54,81	65,75
20	VRUIV020E	15	20	58,46	70,20
25	VRUIV025E	20	10	67,87	81,39
32	VRUIV032E	25	10	81,10	97,37
40	VRUIV040E	32	6	101,21	121,48
50	VRUIV050E	40	6	143,90	172,65
63	VRUIV063E	50	6	209,49	251,37

Válvula anti-retorno inclinada.

Juntas en EPDM o FKM.
H-H enlaces para encolar.

Código en FKM termina en "F"
en lugar de "E"

**VRUFV**

Rh	Ref. EPDM	DN	PN	U/	€ EPDM
3/8"	VRUFV038E	10	16	20	78,64
1/2"	VRUFV012E	15	16	20	81,60
3/4"	VRUFV034E	20	16	10	94,49
1"	VRUFV100E	25	16	10	116,41
1 1/4"	VRUFV114E	32	16	6	147,98
1 1/2"	VRUFV112E	40	16	6	194,90
2"	VRUFV200E	50	16	6	257,79

Válvula anti-retorno inclinada.

Juntas en EPDM. H-H enlaces para rosar.

**VRIV**

d	Ref. EPDM	DN	PN	U/	€ EPDM
75	VRIV075E	65	10	2	312,67
90	VRIV090E	80	6	1	405,81
110	VRIV110E	100	6	1	713,68

Válvula anti-retorno inclinada.

Juntas en EPDM. H-H encolar.

**VRFV**

Rh	Ref. EPDM	DN	PN	U/	€ EPDM
2 1/2"	VRFV212E	65	10	2	435,72
3"	VRFV300E	80	6	1	555,85
4"	VRFV400E	100	6	1	732,68

Válvula anti-retorno inclinada.

Juntas en EPDM. H-H rosar.

**VRDV**

d	Ref. EPDM	DN	PN	U/	€ EPDM
16	VRDV016E	10	16	20	47,67
20	VRDV020E	15	16	20	50,77
25	VRDV025E	20	16	20	58,95
32	VRDV032E	25	16	20	70,53
40	VRDV040E	32	16	12	87,95
50	VRDV050E	40	16	6	125,12
63	VRDV063E	50	16	6	181,56

Válvula anti-retorno inclinada.

Junta en EPDM. M-M encolar.

**SZIV/SZRV***

d	Ref. encolar	Ref. rosar	€ encolar	€ rosar
20	SZIV016		19,88	-
25	SZIV020	SZRV034	21,05	6,59
32	SZIV025	SZRV100	22,21	6,67
40	SZIV032	SZRV114	23,67	6,96
50	SZIV040	SZRV112	44,73	9,65
63	SZIV050	SZRV200	46,00	10,70
75	SZIV063		47,47	-

Tamiz filtro seguridad.

Para válvulas de fondo/pie. Encolar M / Roscar M.

Para recambios de las válvulas consultar el último apartado "Recambios" de esta misma tarifa.

**RVUIV**

d	Ref.	DN	PN	U/	€ EPDM
16	RVUIV016E	10	16	20	45,53
20	RVUIV020E	15	16	20	45,53
25	RVUIV025E	20	16	10	52,67
32	RVUIV032E	25	16	10	71,77
40	RVUIV040E	32	16	6	90,83
50	RVUIV050E	40	16	6	118,89
63	RVUIV063E	50	16	6	154,81

Filtro inclinado PVC-U gris.

Juntas en EPDM. H-H enlaces para encolar.

**RVUIT**

d	Ref.	DN	PN	U/	€ EPDM
16	RVUIT016E	10	16	20	45,53
20	RVUIT020E	15	16	20	45,53
25	RVUIT025E	20	16	10	52,67
32	RVUIT032E	25	16	10	71,77
40	RVUIT040E	32	10	6	90,83
50	RVUIT050E	40	10	6	118,89
63	RVUIT063E	50	10	6	154,81

Filtro inclinado PVC transparente.

Juntas en EPDM. H-H enlaces para encolar.

**RVIV**

d	Ref.	DN	PN	U/	€ EPDM
75	RVIV075E	65	10	2	201,31
90	RVIV090E	80	6	1	240,02
110	RVIV110E	100	6	1	565,29

Filtro inclinado PVC-U gris.

Juntas en EPDM. H-H encolar (sin enlaces en los extremos).

**RVIT**

d	Ref.	DN	PN	U/	€ EPDM
75	RVIT075E	65	6	2	213,50
90	RVIT090E	80	4	1	240,02
110	RVIT110E	100	4	1	565,29

Filtro inclinado PVC-U transparente.

Juntas en EPDM. H-H encolar (sin enlaces en los extremos).

**RVUFV**

Rh	Ref.	DN	PN	U/	€ EPDM
3/8"	RVUFV038E	10	16	20	58,46
1/2"	RVUFV012E	15	16	20	64,94
3/4"	RVUFV034E	20	16	10	77,10
1"	RVUFV100E	25	16	10	102,03
1 1/4"	RVUFV114E	32	16	6	129,41
1 1/2"	RVUFV112E	40	16	6	160,46
2"	RVUFV200E	50	16	6	197,54

Filtro inclinado PVC-U gris.

Juntas en EPDM. H-H enlaces para roscar.

**RVFV**

Rh	Ref.	DN	PN	U/	€ EPDM
2 1/2"	RVFV212E	65	10	2	322,14
3"	RVFV300E	80	6	1	402,80
4"	RVFV400E	100	6	1	603,11

Filtro inclinado PVC-U gris.

Juntas en EPDM. H-H roscar (sin enlaces en los extremos).

Para recambios de las válvulas consultar el último apartado "Recambios" de esta misma tarifa.



RVUFT

Rh	Ref.	DN	PN	U/	€ EPDM
3/8"	RVUFT038E	10	16	20	58,46
1/2"	RVUFT012E	15	16	20	61,25
3/4"	RVUFT034E	20	16	10	80,97
1"	RVUFT100E	25	16	10	108,02
1 1/4"	RVUFT114E	32	10	6	135,14
1 1/2"	RVUFT112E	40	10	6	165,06
2"	RVUFT200E	50	10	6	212,97

Filtro inclinado **PVC transparente**.
 Juntas en EPDM. H-H enlaces para roscar.



RVDV

d	Ref.	DN	PN	U/	€ EPDM
16	RVDV016E	10	16	20	39,51
20	RVDV020E	15	16	20	39,51
25	RVDV025E	20	16	20	45,72
32	RVDV032E	25	16	20	62,37
40	RVDV040E	32	16	12	98,55
50	RVDV050E	40	16	6	103,44
63	RVDV063E	50	16	6	134,61

Filtro inclinado **PVC gris**.
 Junta en EPDM. M-M encolar.



RVDT

d	Ref.	DN	PN	U/	€ EPDM
16	RVDT016E	10	10	20	41,07
20	RVDT020E	15	10	20	41,07
25	RVDT025E	20	10	20	47,60
32	RVDT032E	25	10	20	64,89
40	RVDT040E	32	10	12	82,17
50	RVDT050E	40	10	6	107,57
63	RVDT063E	50	10	6	140,01

Filtro inclinado **PVC transparente**.
 Junta en EPDM. M-M encolar.



RVFT

Rh	Ref.	DN	PN	U/	€ EPDM
2 1/2"	RVFT212E	65	6	2	331,60
3"	RVFT300E	80	4	1	426,33
4"	RVFT400E	100	4	1	612,57

Filtro inclinado **PVC-U transparente**.
 Juntas en EPDM. H-H roscar (sin enlaces en los extremos).



VAIV

d-Rh	Ref.	DN	PN	U/	€ EPDM
20-1/2"	VAIV020E	15	16	16	55,92
25-3/4"	VAIV025E	20	16	20	63,24
32-1"	VAIV032E	25	16	6	68,52
40-1 1/4"	VAIV040E	32	16	3	74,43
50-1 1/2"	VAIV050E	40	16	3	106,97
63-2"	VAIV063E	50	16	3	156,45

Válvula de purga bola ventosa. Se suministra con las piezas necesarias para convertir la válvula roscada hembra por ambos extremos.
 Junta en EPDM.
 H-M encolar / H-H roscar.

Para recambios de las válvulas consultar el último apartado "Recambios" de esta misma tarifa.



0904

Válvulas de solenoide

INDUSTRIA





INDUSTRIA

Válvulas de solenoide



1	2	3	4	5	7
Serie:	Modelo pequeño S1				
	Modelo grande S2				
Vías:	Dos vías	2			
Conexión:	Encolar I				
	Roscar F				
DN:	Modelo pequeño	4-6-8			
	Modelo grande	8-10-15			
Diámetro:	Modelo pequeño	10-12-16-1/4"-3/8"			
	Modelo grande	16-20-3/8"-1/2"			
Juntas:		EPDM-FKM			
Voltaje:		12V-24V-48V-110V-230V			
Corriente:					AC-DC

Válvula de bola maneta azul.

H-H encolar. Junta EPDM - Asiento PE. Bidireccional.



S12IV

d	Ref.	DN	Voltaje	Corriente	€ EPDM
16	S12I0416E2A	04	24 V*	Alterna	275,04
16	S12I0616E2A	06	24 V*	Alterna	275,04
16	S12I0816E2A	08	24 V*	Alterna	275,04
16	S12I0416E2C	04	24 V*	Continua	275,04
16	S12I0616E2C	06	24 V*	Continua	275,04
16	S12I0816E2C	08	24 V*	Continua	275,04
16	S12I0416E5A	04	230 V*	Alterna	275,04
16	S12I0616E5A	06	230 V*	Alterna	275,04
16	S12I0816E5A	08	230 V*	Alterna	275,04

Válvula de solenoide 2 vías **ENCOLAR**. Modelo pequeño.

Juntas EPDM. H-H encolar.

* Voltaje estándar. Disponibles otras conexiones para encolar: BS y ASTM

Disponibles también en diámetro exterior Ø 10 y 12 mm. al mismo precio que las de Ø 16 mm.



S12-S22

d	Modelo encolar	Rh	Ref.	DN	€ EPDM	€ FKM
10	S12IV		S12FV	4-6-8-10	267,01	266,06
12	S12IV	1/4"	S12FV	4-6-8-10	267,01	266,06
16	S12IV	3/8"	S22FV	4-6-8-10	267,01	266,06
16	S22IV	3/8"	S22FV	8-10-15	339,94	345,86
20	S22IV	1/2"	S22IV	8-10-15	339,94	345,86

Resumen

válvulas de solenoide 2 vías.

Voltaje estándar

24 ó 230 V AC 50/60 Hz, 24 V DC

Bajo pedido:

48, 110 V AC 50/60 Hz y 12, 48

V DC



S12IV

d	Ref.	DN	Voltaje	Corriente	€ F
16	S12I0416F2A	04	24 V*	Alterna	290,49
16	S12I0616F2A	06	24 V*	Alterna	290,49
16	S12I0816F2A	08	24 V*	Alterna	290,49
16	S12I1016F2A	10	24 V*	Alterna	290,49
16	S12I0416F2C	04	24 V*	Continua	290,49
16	S12I0616F2C	06	24 V*	Continua	290,49
16	S12I0816F2C	08	24 V*	Continua	290,49
16	S12I0416F5A	04	230 V*	Alterna	290,49
16	S12I0616F5A	06	230 V*	Alterna	290,49
16	S12I0816F5A	08	230 V*	Alterna	290,49
16	S12I1016F5A	10	230 V*	Alterna	290,49

Válvula de solenoide 2 vías **ENCOLAR**. Modelo pequeño.

Juntas FKM. H-H encolar.

* Voltaje estándar. Disponibles otras conexiones para encolar: BS y ASTM

Disponibles también en diámetro exterior Ø 10 y 12 mm. al mismo precio que las de Ø 16 mm.

Marcadas en amarillo los modelos estándar

Para recambios de las válvulas consultar el último apartado "Recambios" de esta misma tarifa.



S12FV

Rh	Ref.	DN	Voltaje	Corriente	€ EPDM
3/8"	S12F0438E2A	04	24 V*	Alterna	275,04
3/8"	S12F0638E2A	06	24 V*	Alterna	275,04
3/8"	S12F0838E2A	08	24 V*	Alterna	275,04
3/8"	S12F0438E2C	04	24 V*	Continua	275,04
3/8"	S12F0638E2C	06	24 V*	Continua	275,04
3/8"	S12F0838E2C	08	24 V*	Continua	275,04
3/8"	S12F0438E5A	04	230 V*	Alterna	275,04
3/8"	S12F0638E5A	06	230 V*	Alterna	275,04
3/8"	S12F0838E5A	08	230 V*	Alterna	275,04

Válvula de solenoide 2 vías **ROSCAR**. Modelo pequeño.

Juntas EPDM. *H-H rosca*.

* Voltaje estándar. Disponibles otras conexiones para encolar: NPT

Disponibles también en diámetro exterior Ø 1/4" al mismo precio que las de diámetro exterior Ø 3/8".



S12FV

Rh	Ref.	DN	Voltaje	Corriente	€ F
3/8"	S12F0438F2A	04	24 V*	Alterna	290,49
3/8"	S12F0638F2A	06	24 V*	Alterna	290,49
3/8"	S12F0838F2A	08	24 V*	Alterna	290,49
3/8"	S12F1038F2A	10	24 V*	Alterna	290,49
3/8"	S12F0438F2C	04	24 V*	Continua	290,49
3/8"	S12F0638F2C	06	24 V*	Continua	290,49
3/8"	S12F0838F2C	08	24 V*	Continua	290,49
3/8"	S12F0438F5A	04	230 V*	Alterna	290,49
3/8"	S12F0638F5A	06	230 V*	Alterna	290,49
3/8"	S12F0838F5A	08	230 V*	Alterna	290,49
3/8"	S12F1038F5A	10	230 V*	Alterna	290,49

Válvula de solenoide 2 vías **ROSCAR**. Modelo pequeño.

Juntas FKM. *H-H rosca*.

* Voltaje estándar. Disponibles otras conexiones para encolar: NPT

Disponibles también en diámetro exterior Ø 1/4" al mismo precio que las de diámetro exterior Ø 3/8".

Marcadas en amarillo los modelos estándar



S22IV

d	Ref.	DN	Voltaje	Corriente	€ EPDM
20	S22I0820E2A	08	24 V*	Alterna	350,15
20	S22I1020E2A	10	24 V*	Alterna	350,15
20	S22I1520E2A	15	24 V*	Alterna	350,15
20	S22I0820E2C	08	24 V*	Continua	350,15
20	S22I1020E2C	10	24 V*	Continua	350,15
20	S22I1520E2C	15	24 V*	Continua	350,15
20	S22I0820E5A	08	230 V*	Alterna	350,15
20	S22I1020E5A	10	230 V*	Alterna	350,15
20	S22I1520E5A	15	230 V*	Alterna	350,15

Válvula de solenoide 2 vías **ENCOLAR**. Modelo grande.

Juntas EPDM. *H-H encolar*.

* Voltaje estándar. Disponibles otras conexiones para encolar: BS y ASTM

Disponibles también en diámetro exterior Ø 16 mm. al mismo precio que las de Ø 20 mm.



S22IV

d	Ref.	DN	Voltaje	Corriente	€ FKM
20	S22I0820F2A	08	24 V*	Alterna	369,15
20	S22I1020F2A	10	24 V*	Alterna	369,15
20	S22I1520F2A	15	24 V*	Alterna	369,15
20	S22I0820F2C	08	24 V*	Continua	369,15
20	S22I1020F2C	10	24 V*	Continua	369,15
20	S22I1520F2C	15	24 V*	Continua	369,15
20	S22I0820F5A	08	230 V*	Alterna	369,15
20	S22I1020F5A	10	230 V*	Alterna	369,15
20	S22I1520F5A	15	230 V*	Alterna	369,15

Válvula de solenoide 2 vías **ENCOLAR**. Modelo grande.

Juntas FKM. *H-H encolar*.

* Voltaje estándar. Disponibles otras conexiones para encolar: BS y ASTM

Disponibles también en diámetro exterior Ø 16 mm. al mismo precio que las de Ø 20 mm.

Marcadas en amarillo los modelos estándar

Para recambios de las válvulas consultar el último apartado "Recambios" de esta misma tarifa.



S22FV

Rh	Ref.	DN	Voltaje	Corriente	€ EPDM
½"	S22F0812E2A	08	24 V*	Alterna	350,15
½"	S22F1012E2A	10	24 V*	Alterna	350,15
½"	S22F1512E2A	15	24 V*	Alterna	350,15
½"	S22F0812E2C	08	24 V*	Continua	350,15
½"	S22F1012E2C	10	24 V*	Continua	350,15
½"	S22F1512E2C	15	24 V*	Continua	350,15
½"	S22F0812E5A	08	230 V*	Alterna	350,15
½"	S22F1012E5A	10	230 V*	Alterna	350,15
½"	S22F1512E5A	15	230 V*	Alterna	350,15

Válvula de solenoide 2 vías **ROSCAR**. Modelo grande.

Juntas EPDM. *HH rosca*.

* Voltaje estándar. Disponibles otras conexiones para encolar: NPT.

Disponibles también en diámetro exterior Ø 3/8" al mismo precio que las de diámetro exterior Ø 1/2".



S22FV

Rh	Ref.	DN	Voltaje	Corriente	€ FKM
½"	S22F0812F2A	08	24 V*	Alterna	369,15
½"	S22F1012F2A	10	24 V*	Alterna	369,15
½"	S22F1512F2A	15	24 V*	Alterna	369,15
½"	S22F0812F2C	08	24 V*	Continua	369,15
½"	S22F1012F2C	10	24 V*	Continua	369,15
½"	S22F1512F2C	15	24 V*	Continua	369,15
½"	S22F0812F5A	08	230 V*	Alterna	369,15
½"	S22F1012F5A	10	230 V*	Alterna	369,15
½"	S22F1512F5A	15	230 V*	Alterna	369,15

Válvula de solenoide 2 vías **ROSCAR**. Modelo grande.

Juntas FKM. *HH rosca*.

* Voltaje estándar. Disponibles otras conexiones para encolar: NPT.

Disponibles también en diámetro exterior Ø 3/8" al mismo precio que las de diámetro exterior Ø 1/2".

Marcadas en amarillo los modelos estándar

Válvulas de bola actuadas

Válvula de 3 vías actuadas

Válvulas de mariposa

Válvulas de membrana

Válvulas de control de presión



0808

Válvulas motorizadas PVC-U presión

INDUSTRIA





Válvulas motorizadas

Motorizando nuestra válvula industrial conseguimos que nuestras válvulas (con el par más bajo del mercado siendo estanca) puedan trabajar con un número de aperturas y cierres muy por encima de la media.

NO TODAS LAS VÁLVULAS MOTORIZADAS DEL MERCADO SON IGUALES O SEMEJANTES.

En estos artículos, donde el precio del actuador es más elevado que el de la válvula, es donde más énfasis hay que tener en colocar la mejor válvula del mercado. El precio de la válvula no se apreciará porque quedará absorbido por el precio del actuador. Una buena válvula hará que alargue su uso, su mantenimiento, su seguridad y su durabilidad.





INDUSTRIA

Válvulas motorizadas de PVC-U presión

Válvulas de bola actuadas



VKDIV/CE

encolar.

VKDFFV/CE

roscar.



ACTUACIÓN ELÉCTRICA

ACTUACIÓN ELÉCTRICA CON BLOQUE DE SEGURIDAD

d-Rh	24-240 V AC/DC		24-240 V AC/DC		24-240 V AC/DC		24-240 V AC/DC	
	Ref.	€ EPDM	Ref.	€ FKM	Ref.	€ EPDM	Ref.	€ FKM
16	VKVE016E2D	625,73	VKVE016F2D	634,53	VKVE016E2BD	1.180,41	VKVE016F2BD	1.189,22
20	VKVE020E2D	627,37	VKVE020F2D	635,85	VKVE020E2BD	1.182,03	VKVE020F2BD	1.190,53
25	VKVE025E2D	638,14	VKVE025F2D	649,03	VKVE025E2BD	1.192,84	VKVE025F2BD	1.203,71
32	VKVE032E2D	650,75	VKVE032F2D	664,04	VKVE032E2BD	1.205,41	VKVE032F2BD	1.218,73
40	VKVE040E2D	673,55	VKVE040F2D	688,04	VKVE040E2BD	1.228,22	VKVE040F2BD	1.242,73
50	VKVE050E2D	696,47	VKVE050F2D	714,54	VKVE050E2BD	1.251,12	VKVE050F2BD	1.269,25
63	VKVE063E2D	725,05	VKVE063F2D	760,79	VKVE063E2BD	1.279,72	VKVE063F2BD	1.315,46
75	VKVE075E2D	1.160,84	VKVE075F2D	1.232,63	VKVE075E2BD	1.715,52	VKVE075F2BD	1.787,31
90	VKVE090E2D	1.260,65	VKVE090F2D	1.348,20	VKVE090E2BD	1.815,32	VKVE090F2BD	1.902,85
110	VKVE110E2D	1.696,10	VKVE110F2D	1.816,92	VKVE110E2BD	2.250,79	VKVE110F2BD	2.371,61

3/8"	VKVE038E2D	628,92	VKVE038F2D	638,32	VKVE038E2BD	1.183,60	VKVE038F2BD	1.192,98
1/2"	VKVE012E2D	631,08	VKVE012F2D	640,35	VKVE012E2BD	1.185,77	VKVE012F2BD	1.195,01
3/4"	VKVE034E2D	643,18	VKVE034F2D	652,12	VKVE034E2BD	1.197,87	VKVE034F2BD	1.206,80
1"	VKVE100E2D	655,96	VKVE100F2D	673,83	VKVE100E2BD	1.210,64	VKVE100F2BD	1.228,51
1 1/4"	VKVE114E2D	681,81	VKVE114F2D	696,59	VKVE114E2BD	1.236,49	VKVE114F2BD	1.251,24
1 1/2"	VKVE112E2D	709,03	VKVE112F2D	727,67	VKVE112E2BD	1.263,69	VKVE112F2BD	1.282,35
2"	VKVE200E2D	742,35	VKVE200F2D	779,43	VKVE200E2BD	1.297,01	VKVE200F2BD	1.334,11
2 1/2"	VKVE212E2D	1.190,01	VKVE212F2D	1.261,80	VKVE212E2BD	1.744,70	VKVE212F2BD	1.816,46
3"	VKVE300E2D	1.297,78	VKVE300F2D	1.385,38	VKVE300E2BD	1.852,46	VKVE300F2BD	1.940,04
4"	VKVE400E2D	1.737,85	VKVE400F2D	1.858,69	VKVE400E2BD	2.292,52	VKVE400F2BD	2.413,34

Válvula de bola motorizada en PVC-U 2 vías DUAL BLOCK®. Actuación eléctrica.

Disponemos de otras conexiones bajo pedido: bridas, encolar (BS, ASTM, JIS) y roscar (NPT, JIS). Bajo pedido podemos suministrar otros actuadores: VALPES, BELIMO...
Bajo pedido también disponibles en 12V AC/DC

VKRIV/CE

encolar.

VKRFV/CE

roscar.



ACTUACIÓN ELÉCTRICA 24-240 V AC/DC CON POSICIONADOR 4-20 mA

d	Ref.	€		Ref.	€		Ref.	€		Rh
		EPDM	FKM		EPDM	FKM		EPDM	FKM	
16	VRVE016E2PD	1.217,51	1.226,32	VRVE016F2PD	1.220,79	1.220,79	VRVE038E2PD	1.220,79	3/8"	
20	VRVE020E2PD	1.219,24	1.227,64	VRVE020F2PD	1.222,90	1.222,90	VRVE012E2PD	1.222,90	1/2"	
25	VRVE025E2PD	1.243,19	1.254,03	VRVE025F2PD	1.248,15	1.248,15	VRVE034E2PD	1.248,15	3/4"	
32	VRVE032E2PD	1.281,66	1.294,95	VRVE032F2PD	1.286,91	1.286,91	VRVE100E2PD	1.286,91	1"	
40	VRVE040E2PD	1.301,90	1.316,42	VRVE040F2PD	1.310,14	1.310,14	VRVE114E2PD	1.310,14	1 1/4"	
50	VRVE050E2PD	1.377,06	1.395,17	VRVE050F2PD	1.389,68	1.389,68	VRVE112E2PD	1.389,68	1 1/2"	
63	VRVE063E2PD	1.393,85	1.429,64	VRVE063F2PD	1.411,20	1.411,20	VRVE200E2PD	1.411,20	2"	

Válvula de bola REGULACIÓN motorizada en PVC-U 2 vías DUAL BLOCK®. Actuación eléctrica con posicionador 4-20 mA

Disponemos de otras conexiones bajo pedido: bridas, encolar (BS, ASTM, JIS) y roscar (NPT, JIS). Bajo pedido también disponibles en 12V AC/DC

**VKDIV/CP**

encolar.

VKDFV/CP

roscar.

ACTUACIÓN NEUMÁTICA ALUMINIO

ACTUACIÓN NEUMÁTICA ALUMINIO CON ELECTROVÁLVULA, FINALES DE CARRERA (ELECTROMECAÑICOS) Y REGULADORES DE ESCAPE

d-Rh	DOBLE EFECTO €		SIMPLE EFECTO €		DOBLE EFECTO €		SIMPLE EFECTO €	
	Ref.		Ref.		Ref.		Ref.	
16	VKVP016EDED	288,35	VKVP016ESED	319,04	VKVP016EDEFD	488,97	VKVP016ESEFD	530,24
20	VKVP020EDED	289,98	VKVP020ESED	320,69	VKVP020EDEFD	490,62	VKVP020ESEFD	531,92
25	VKVP025EDED	300,76	VKVP025ESED	331,48	VKVP025EDEFD	501,40	VKVP025ESEFD	542,71
32	VKVP032EDED	313,38	VKVP032ESED	344,07	VKVP032EDEFD	514,00	VKVP032ESEFD	555,32
40	VKVP040EDED	336,17	VKVP040ESED	366,89	VKVP040EDEFD	536,82	VKVP040ESEFD	578,12
50	VKVP050EDED	359,11	VKVP050ESED	449,44	VKVP050EDEFD	559,73	VKVP050ESEFD	660,64
63	VKVP063EDED	387,67	VKVP063ESED	556,92	VKVP063EDEFD	588,28	VKVP063ESEFD	768,15
75	VKVP075EDED	662,17	VKVP075ESED	781,87	VKVP075EDEFD	862,76	VKVP075ESEFD	993,11
90	VKVP090EDED	761,97	VKVP090ESED	881,66	VKVP090EDEFD	962,57	VKVP090ESEFD	1.092,91
110	VKVP110EDED	846,74	VKVP110ESED	1.270,48	VKVP110EDEFD	1.047,39	VKVP110ESEFD	1.481,71

3/8"	VKVP038EDED	291,54	VKVP038ESED	322,27	VKVP038EDEFD	492,19	VKVP038ESEFD	533,49
1/2"	VKVP012EDED	293,74	VKVP012ESED	324,43	VKVP012EDEFD	494,35	VKVP012ESEFD	535,65
3/4"	VKVP034EDED	305,81	VKVP034ESED	336,53	VKVP034EDEFD	506,43	VKVP034ESEFD	547,73
1"	VKVP100EDED	318,58	VKVP100ESED	349,30	VKVP100EDEFD	519,22	VKVP100ESEFD	560,51
1 1/4"	VKVP114EDED	344,41	VKVP114ESED	375,16	VKVP114EDEFD	545,06	VKVP114ESEFD	586,38
1 1/2"	VKVP112EDED	371,65	VKVP112ESED	461,99	VKVP112EDEFD	572,27	VKVP112ESEFD	673,21
2"	VKVP200EDED	405,00	VKVP200ESED	574,20	VKVP200EDEFD	605,59	VKVP200ESEFD	785,43
2 1/2"	VKVP212EDED	691,34	VKVP212ESED	811,05	VKVP212EDEFD	891,96	VKVP212ESEFD	1.022,28
3"	VKVP300EDED	799,07	VKVP300ESED	918,81	VKVP300EDEFD	999,70	VKVP300ESEFD	1.130,01
4"	VKVP400EDED	888,51	VKVP400ESED	1.312,27	VKVP400EDEFD	1.089,15	VKVP400ESEFD	1.523,47

16	VKVP016FDED	297,16	VKVP016FSED	327,88	VKVP016FDEFD	497,78	VKVP016FSEFD	539,10
20	VKVP020FDED	298,47	VKVP020FSED	329,19	VKVP020FDEFD	499,09	VKVP020FSEFD	540,42
25	VKVP025FDED	311,66	VKVP025FSED	342,37	VKVP025FDEFD	512,30	VKVP025FSEFD	553,60
32	VKVP032FDED	326,66	VKVP032FSED	357,36	VKVP032FDEFD	527,31	VKVP032FSEFD	568,59
40	VKVP040FDED	350,66	VKVP040FSED	381,39	VKVP040FDEFD	551,31	VKVP040FSEFD	592,61
50	VKVP050FDED	377,19	VKVP050FSED	467,52	VKVP050FDEFD	577,83	VKVP050FSEFD	678,77
63	VKVP063FDED	423,41	VKVP063FSED	592,66	VKVP063FDEFD	624,06	VKVP063FSEFD	803,89
75	VKVP075FDED	733,93	VKVP075FSED	853,66	VKVP075FDEFD	934,57	VKVP075FSEFD	1.064,90
90	VKVP090FDED	849,47	VKVP090FSED	969,23	VKVP090FDEFD	1.050,12	VKVP090FSEFD	1.180,46
110	VKVP110FDED	967,56	VKVP110FSED	1.391,32	VKVP110FDEFD	1.168,21	VKVP110FSEFD	1.602,56

3/8"	VKVP038FDED	300,95	VKVP038FSED	331,66	VKVP038FDEFD	501,56	VKVP038FSEFD	542,89
1/2"	VKVP012FDED	302,97	VKVP012FSED	333,65	VKVP012FDEFD	503,60	VKVP012FSEFD	544,90
3/4"	VKVP034FDED	314,75	VKVP034FSED	345,46	VKVP034FDEFD	515,39	VKVP034FSEFD	556,69
1"	VKVP100FDED	336,48	VKVP100FSED	367,17	VKVP100FDEFD	537,07	VKVP100FSEFD	578,40
1 1/4"	VKVP114FDED	359,21	VKVP114FSED	389,91	VKVP114FDEFD	559,84	VKVP114FSEFD	601,14
1 1/2"	VKVP112FDED	390,30	VKVP112FSED	480,65	VKVP112FDEFD	590,94	VKVP112FSEFD	691,90
2"	VKVP200FDED	442,06	VKVP200FSED	611,28	VKVP200FDEFD	642,67	VKVP200FSEFD	822,51
2 1/2"	VKVP212FDED	763,08	VKVP212FSED	882,84	VKVP212FDEFD	963,72	VKVP212FSEFD	1.094,07
3"	VKVP300FDED	886,68	VKVP300FSED	1.006,41	VKVP300FDEFD	1.087,30	VKVP300FSEFD	1.217,65
4"	VKVP400FDED	1.009,33	VKVP400FSED	1.433,09	VKVP400FDEFD	1.209,94	VKVP400FSEFD	1.644,32

Válvula de bola motorizada en PVC-U 2 vías DUAL BLOCK®. Actuación neumática.

Disponemos de otras conexiones bajo pedido: bridas, encolar (BS, ASTM, JIS) y roscar (NPT, JIS). Las válvulas neumáticas se configuran NC (normalmente cerrada) de serie. La configuración NA (normalmente abierta) se debe especificar en el pedido.

VKRIV/CP

encolar.

VKRFV/CP

roscar.

ACTUACIÓN NEUMÁTICA ALUMINIO DOBLE EFECTO
CON POSICIONADOR 4-20 mAACTUACIÓN NEUMÁTICA ALUMINIO SIMPLE EFECTO
CON POSICIONADOR 4-20 mA

d-Rh	Ref.	€ EPDM	Ref.	€ FKM	Ref.	€ EPDM	Ref.	€ FKM
16	VRVP016EDEPD	2.203,53	VRVP016FDEPD	2.212,34	VRVP016ESEPD	2.234,20	VRVP016FSEPD	2.243,03
20	VRVP020EDEPD	2.205,23	VRVP020FDEPD	2.213,66	VRVP020ESEPD	2.235,92	VRVP020FSEPD	2.244,35
25	VRVP025EDEPD	2.229,18	VRVP025FDEPD	2.239,99	VRVP025ESEPD	2.259,87	VRVP025FSEPD	2.270,72
32	VRVP032EDEPD	2.267,68	VRVP032FDEPD	2.280,97	VRVP032ESEPD	2.298,39	VRVP032FSEPD	2.311,68
40	VRVP040EDEPD	2.287,92	VRVP040FDEPD	2.302,41	VRVP040ESEPD	2.318,61	VRVP040FSEPD	2.333,10
50	VRVP050EDEPD	2.363,06	VRVP050FDEPD	2.381,15	VRVP050ESEPD	2.453,41	VRVP050FSEPD	2.471,52
63	VRVP063EDEPD	2.379,85	VRVP063FDEPD	2.415,66	VRVP063ESEPD	2.549,07	VRVP063FSEPD	2.584,89

3/8"	VRVP038EDEPD	2.206,78	VRVP038FDEPD	2.206,78	VRVP038ESEPD	2.237,47	VRVP038FSEPD	2.237,47
1/2"	VRVP012EDEPD	2.208,92	VRVP012FDEPD	2.208,92	VRVP012ESEPD	2.239,61	VRVP012FSEPD	2.239,61
3/4"	VRVP034EDEPD	2.234,17	VRVP034FDEPD	2.234,17	VRVP034ESEPD	2.264,87	VRVP034FSEPD	2.264,87
1"	VRVP100EDEPD	2.272,90	VRVP100FDEPD	2.272,90	VRVP100ESEPD	2.303,60	VRVP100FSEPD	2.303,60
1 1/4"	VRVP114EDEPD	2.296,16	VRVP114FDEPD	2.296,16	VRVP114ESEPD	2.326,87	VRVP114FSEPD	2.326,87
1 1/2"	VRVP112EDEPD	2.375,67	VRVP112FDEPD	2.375,67	VRVP112ESEPD	2.466,03	VRVP112FSEPD	2.466,03
2"	VRVP200EDEPD	2.397,22	VRVP200FDEPD	2.397,22	VRVP200ESEPD	2.566,43	VRVP200FSEPD	2.566,43

Válvula de bola REGULACIÓN motorizada en PVC-U 2 vías DUAL BLOCK®.

Actuación neumática con posicionador 4-20 mA.

Disponemos de otras conexiones bajo pedido: bridas, encolar (BS, ASTM, JIS) y roscar (NPT, JIS)

Las válvulas neumáticas se configuran NC (normalmente cerrada) de serie. La configuración NA (normalmente abierta) se debe especificar en el pedido.

VKRIV/CP

encolar.

VKRFV/CP

roscar.

ACTUACIÓN NEUMÁTICA POLIAMIDA DOBLE EFECTO
CON POSICIONADOR 4-20 mAACTUACIÓN NEUMÁTICA POLIAMIDA SIMPLE EFECTO
CON POSICIONADOR 4-20 mA

d-Rh	Ref.	€ EPDM	Ref.	€ FKM	Ref.	€ EPDM	Ref.	€ FKM
16	VRVP016EDEPP	1.763,82	VRVP016FDEPP	1.772,63	VRVP016ESEPP	1.786,98	VRVP016FSEPP	1.795,78
20	VRVP020EDEPP	1.765,55	VRVP020FDEPP	1.773,97	VRVP020ESEPP	1.788,70	VRVP020FSEPP	1.797,09
25	VRVP025EDEPP	1.789,50	VRVP025FDEPP	1.800,32	VRVP025ESEPP	1.812,65	VRVP025FSEPP	1.823,44
32	VRVP032EDEPP	1.827,99	VRVP032FDEPP	1.841,28	VRVP032ESEPP	1.955,23	VRVP032FSEPP	1.968,54
40	VRVP040EDEPP	1.848,21	VRVP040FDEPP	1.862,70	VRVP040ESEPP	1.975,44	VRVP040FSEPP	1.989,94
50	VRVP050EDEPP	1.923,37	VRVP050FDEPP	1.941,48	VRVP050ESEPP	2.172,06	VRVP050FSEPP	2.190,17
63	VRVP063EDEPP	2.144,23	VRVP063FDEPP	2.180,03	VRVP063ESEPP	2.210,72	VRVP063FSEPP	2.246,53

3/8"	VRVP038EDEPP	1.767,07	VRVP038FDEPP	1.767,07	VRVP038ESEPP	1.790,22	VRVP038FSEPP	1.790,22
1/2"	VRVP012EDEPP	1.769,21	VRVP012FDEPP	1.769,21	VRVP012ESEPP	1.792,35	VRVP012FSEPP	1.792,35
3/4"	VRVP034EDEPP	1.794,47	VRVP034FDEPP	1.794,47	VRVP034ESEPP	1.817,62	VRVP034FSEPP	1.817,62
1"	VRVP100EDEPP	1.833,19	VRVP100FDEPP	1.833,19	VRVP100ESEPP	1.960,43	VRVP100FSEPP	1.960,43
1 1/4"	VRVP114EDEPP	1.856,45	VRVP114FDEPP	1.856,45	VRVP114ESEPP	1.983,71	VRVP114FSEPP	1.983,71
1 1/2"	VRVP112EDEPP	1.935,99	VRVP112FDEPP	1.935,99	VRVP112ESEPP	2.184,68	VRVP112FSEPP	2.184,68
2"	VRVP200EDEPP	2.161,59	VRVP200FDEPP	2.161,59	VRVP200ESEPP	2.228,08	VRVP200FSEPP	2.228,08

Válvula de bola REGULACIÓN motorizada en PVC-U 2 vías DUAL BLOCK®.

Actuación neumática con posicionador 4-20 mA.

Disponemos de otras conexiones bajo pedido: bridas, encolar (BS, ASTM, JIS) y roscar (NPT, JIS)

Las válvulas neumáticas se configuran NC (normalmente cerrada) de serie. La configuración NA (normalmente abierta) se debe especificar en el pedido.

VKDIV/CP

encolar.

VKDFV/CP

roscar.

ACTUACIÓN NEUMÁTICA POLIAMIDA

ACTUACIÓN NEUMÁTICA POLIAMIDA CON ELECTROVÁLVULA, FINALES DE CARRERA (ELECTROMECÁNICOS) Y REGULADORES DE ESCAPE



d-Rh	DOBLE EFECTO €		SIMPLE EFECTO €		DOBLE EFECTO €		SIMPLE EFECTO €	
	Ref.		Ref.		Ref.		Ref.	
16	VKVP016EDEP	307,04	VKVP016ESEP	330,22	VKVP016EDEFP	569,52	VKVP016ESEFP	592,66
20	VKVP020EDEP	308,74	VKVP020ESEP	331,87	VKVP020EDEFP	571,17	VKVP020ESEFP	594,31
25	VKVP025EDEP	319,49	VKVP025ESEP	342,63	VKVP025EDEFP	581,93	VKVP025ESEFP	605,07
32	VKVP032EDEP	332,12	VKVP032ESEP	459,36	VKVP032EDEFP	594,55	VKVP032ESEFP	721,80
40	VKVP040EDEP	354,92	VKVP040ESEP	482,12	VKVP040EDEFP	617,36	VKVP040ESEFP	744,59
50	VKVP050EDEP	377,83	VKVP050ESEP	626,50	VKVP050EDEFP	640,25	VKVP050ESEFP	888,97
63	VKVP063EDEP	610,48	VKVP063ESEP	677,00	VKVP063EDEFP	872,93	VKVP063ESEFP	939,41
75	VKVP075EDEP	791,17	VKVP075ESEP	1.040,33	VKVP075EDEFP	1.053,62	VKVP075ESEFP	1.302,74
90	VKVP090EDEP	890,95	VKVP090ESEP	1.140,14	VKVP090EDEFP	1.153,39	VKVP090ESEFP	1.402,55
110	VKVP110EDEP	942,35	VKVP110ESEP	1.212,75	VKVP110EDEFP	1.204,79	VKVP110ESEFP	1.475,20

3/8"	VKVP038EDEP	310,29	VKVP038ESEP	333,44	VKVP038EDEFP	572,73	VKVP038ESEFP	595,89
1/2"	VKVP012EDEP	312,48	VKVP012ESEP	335,60	VKVP012EDEFP	574,89	VKVP012ESEFP	598,05
3/4"	VKVP034EDEP	324,53	VKVP034ESEP	347,68	VKVP034EDEFP	586,98	VKVP034ESEFP	610,12
1"	VKVP100EDEP	337,33	VKVP100ESEP	464,56	VKVP100EDEFP	599,77	VKVP100ESEFP	727,03
1 1/4"	VKVP114EDEP	363,13	VKVP114ESEP	490,38	VKVP114EDEFP	625,60	VKVP114ESEFP	752,83
1 1/2"	VKVP112EDEP	390,35	VKVP112ESEP	639,09	VKVP112EDEFP	652,79	VKVP112ESEFP	901,51
2"	VKVP200EDEP	627,79	VKVP200ESEP	694,27	VKVP200EDEFP	890,23	VKVP200ESEFP	956,72
2 1/2"	VKVP212EDEP	820,32	VKVP212ESEP	1.069,48	VKVP212EDEFP	1.082,79	VKVP212ESEFP	1.331,92
3"	VKVP300EDEP	928,06	VKVP300ESEP	1.177,24	VKVP300EDEFP	1.190,53	VKVP300ESEFP	1.439,66
4"	VKVP400EDEP	984,11	VKVP400ESEP	1.254,52	VKVP400EDEFP	1.246,56	VKVP400ESEFP	1.516,96

16	VKVP016FDEP	315,90	VKVP016FSEP	339,06	VKVP016FDEFP	578,35	VKVP016FSEFP	601,50
20	VKVP020FDEP	317,22	VKVP020FSEP	340,36	VKVP020FDEFP	579,66	VKVP020FSEFP	602,81
25	VKVP025FDEP	330,37	VKVP025FSEP	353,55	VKVP025FDEFP	592,85	VKVP025FSEFP	615,99
32	VKVP032FDEP	345,41	VKVP032FSEP	472,65	VKVP032FDEFP	607,83	VKVP032FSEFP	735,06
40	VKVP040FDEP	369,41	VKVP040FSEP	496,65	VKVP040FDEFP	631,83	VKVP040FSEFP	759,09
50	VKVP050FDEP	395,93	VKVP050FSEP	644,63	VKVP050FDEFP	658,36	VKVP050FSEFP	907,07
63	VKVP063FDEP	646,22	VKVP063FSEP	712,74	VKVP063FDEFP	908,65	VKVP063FSEFP	975,20
75	VKVP075FDEP	862,96	VKVP075FSEP	1.112,12	VKVP075FDEFP	1.125,38	VKVP075FSEFP	1.374,54
90	VKVP090FDEP	978,48	VKVP090FSEP	1.227,64	VKVP090FDEFP	1.240,92	VKVP090FSEFP	1.490,10
110	VKVP110FDEP	1.063,17	VKVP110FSEP	1.333,57	VKVP110FDEFP	1.325,61	VKVP110FSEFP	1.596,04

3/8"	VKVP038FDEP	319,69	VKVP038FSEP	342,81	VKVP038FDEFP	582,14	VKVP038FSEFP	605,26
1/2"	VKVP012FDEP	321,67	VKVP012FSEP	344,82	VKVP012FDEFP	584,11	VKVP012FSEFP	607,27
3/4"	VKVP034FDEP	333,49	VKVP034FSEP	356,64	VKVP034FDEFP	595,91	VKVP034FSEFP	619,06
1"	VKVP100FDEP	355,20	VKVP100FSEP	482,43	VKVP100FDEFP	617,64	VKVP100FSEFP	744,88
1 1/4"	VKVP114FDEP	377,96	VKVP114FSEP	505,19	VKVP114FDEFP	640,38	VKVP114FSEFP	767,64
1 1/2"	VKVP112FDEP	409,04	VKVP112FSEP	657,74	VKVP112FDEFP	671,49	VKVP112FSEFP	920,18
2"	VKVP200FDEP	664,84	VKVP200FSEP	731,35	VKVP200FDEFP	927,29	VKVP200FSEFP	993,80
2 1/2"	VKVP212FDEP	892,11	VKVP212FSEP	1.141,24	VKVP212FDEFP	1.154,56	VKVP212FSEFP	1.403,68
3"	VKVP300FDEP	1.015,68	VKVP300FSEP	1.264,82	VKVP300FDEFP	1.278,13	VKVP300FSEFP	1.527,26
4"	VKVP400FDEP	1.104,96	VKVP400FSEP	1.375,36	VKVP400FDEFP	1.367,38	VKVP400FSEFP	1.637,80

Válvula de bola motorizada en PVC-U 2 vías DUAL BLOCK®. Actuación neumática.

Disponemos de otras conexiones bajo pedido: bridas, encolar (BS, ASTM, JIS) y roscar (NPT, JIS). Las válvulas neumáticas se configuran NC (normalmente cerrada) de serie. La configuración NA (normalmente abierta) se debe especificar en el pedido.



INDUSTRIA

Válvulas motorizadas de PVC-U presión

Válvulas de 3 vías actuadas



LKDIV/CE
encolar.

LKDFV/CE
roscar.

ACTUACIÓN ELÉCTRICA

ACTUACIÓN ELÉCTRICA CON BLOQUE DE SEGURIDAD

d-Rh	24-240 V AC/DC		24-240 V AC/DC		24-240 V AC/DC		24-240 V AC/DC	
	Ref.	€	Ref.	€	Ref.	€	Ref.	€
16	LKVE016E2D	699,89	LKVE016F2D	714,97	LKVE016E2BD	1.254,59	LKVE016F2BD	1.269,63
20	LKVE020E2D	702,31	LKVE020F2D	717,65	LKVE020E2BD	1.256,99	LKVE020F2BD	1.272,36
25	LKVE025E2D	723,78	LKVE025F2D	744,31	LKVE025E2BD	1.278,49	LKVE025F2BD	1.298,96
32	LKVE032E2D	756,57	LKVE032F2D	781,98	LKVE032E2BD	1.311,22	LKVE032F2BD	1.336,68
40	LKVE040E2D	798,77	LKVE040F2D	835,62	LKVE040E2BD	1.353,47	LKVE040F2BD	1.390,29
50	LKVE050E2D	841,33	LKVE050F2D	903,10	LKVE050E2BD	1.396,04	LKVE050F2BD	1.457,76
63	LKVE063E2D	909,57	LKVE063F2D	987,54	LKVE063E2BD	1.464,25	LKVE063F2BD	1.542,22
3/8"	LKVE038E2D	710,42	LKVE038F2D	725,51	LKVE038E2BD	1.265,13	LKVE038F2BD	1.280,17
1/2"	LKVE012E2D	713,02	LKVE012F2D	728,45	LKVE012E2BD	1.267,70	LKVE012F2BD	1.283,10
3/4"	LKVE034E2D	736,17	LKVE034F2D	756,69	LKVE034E2BD	1.290,85	LKVE034F2BD	1.311,38
1"	LKVE100E2D	771,88	LKVE100F2D	797,32	LKVE100E2BD	1.326,57	LKVE100F2BD	1.352,03
1 1/4"	LKVE114E2D	817,41	LKVE114F2D	854,18	LKVE114E2BD	1.372,09	LKVE114F2BD	1.408,86
1 1/2"	LKVE112E2D	863,81	LKVE112F2D	925,61	LKVE112E2BD	1.418,46	LKVE112F2BD	1.480,30
2"	LKVE200E2D	937,95	LKVE200F2D	1.015,87	LKVE200E2BD	1.492,62	LKVE200F2BD	1.570,54

Válvula de bola motorizada en PVC-U 3 vías DUAL BLOCK®. Actuación eléctrica.

Estándar paso en L, paso en T opcional, al mismo precio. Bajo pedido podemos suministrar otros actuadores: VALPES, BELIMO... Disponemos de otras conexiones bajo pedido: bridas, encolar (BS, ASTM, JIS) y roscar (NPT, JIS).
Bajo pedido también disponibles en 12V AC/DC



Medida	Ref. EPDM	DN	PN	€
140	63072	125	10	1.794,64

Válvula Ø 140 con actuador neumático. Brida.

Medida	Ref. EPDM	DN	PN	€
140	63073	125	10	2.807,94

Válvula Ø 140 con actuador eléctrico. Brida.

LKDIV/CP

encolar.

LKDFV/CP

roscar.

ACTUACIÓN NEUMÁTICA ALUMINIO

ACTUACIÓN NEUMÁTICA ALUMINIO CON ELECTROVÁLVULA, FINALES DE CARRERA (ELECTROMECAÑICOS) Y REGULADORES DE ESCAPE



	d-Rh	DOBLE EFECTO €		SIMPLE EFECTO €		DOBLE EFECTO €		SIMPLE EFECTO €	
		Ref.	Ref.	Ref.	Ref.	Ref.	Ref.	Ref.	Ref.
ENCOLAR	16	LKVP016EDED	393,31	LKVP016ESED	393,23	LKVP016EDEFD	563,15	LKVP016ESEFD	604,46
	20	LKVP020EDED	364,93	LKVP020ESED	395,65	LKVP020EDEFD	565,57	LKVP020ESEFD	606,86
	25	LKVP025EDED	386,44	LKVP025ESED	417,13	LKVP025EDEFD	587,03	LKVP025ESEFD	628,35
	32	LKVP032EDED	419,19	LKVP032ESED	449,90	LKVP032EDEFD	619,83	LKVP032ESEFD	661,11
	40	LKVP040EDED	461,39	LKVP040ESED	551,75	LKVP040EDEFD	662,01	LKVP040ESEFD	762,97
ROSCAR	50	LKVP050EDED	539,72	LKVP050ESED	673,21	LKVP050EDEFD	740,36	LKVP050ESEFD	884,41
	63	LKVP063EDED	607,96	LKVP063ESED	741,42	LKVP063EDEFD	808,58	LKVP063ESEFD	952,65
ENCOLAR	3/8"	LKVP038EDED	373,05	LKVP038ESED	403,76	LKVP038EDEFD	573,69	LKVP038ESEFD	614,99
	1/2"	LKVP012EDED	375,64	LKVP012ESED	406,37	LKVP012EDEFD	576,26	LKVP012ESEFD	617,57
	3/4"	LKVP034EDED	398,76	LKVP034ESED	429,51	LKVP034EDEFD	599,41	LKVP034ESEFD	640,71
	1"	LKVP100EDED	434,56	LKVP100ESED	465,25	LKVP100EDEFD	635,18	LKVP100ESEFD	676,48
	1 1/4"	LKVP114EDED	685,35	LKVP114ESED	570,39	LKVP114EDEFD	680,65	LKVP114ESEFD	781,62
ROSCAR	1 1/2"	LKVP112EDED	562,20	LKVP112ESED	695,66	LKVP112EDEFD	762,80	LKVP112ESEFD	906,86
	2"	LKVP200EDED	636,31	LKVP200ESED	769,82	LKVP200EDEFD	836,96	LKVP200ESEFD	981,02
ENCOLAR	16	LKVP016FDED	377,60	LKVP016FSED	408,32	LKVP016FDEFD	578,22	LKVP016FSEFD	619,52
	20	LKVP020FDED	380,28	LKVP020FSED	411,00	LKVP020FDEFD	580,92	LKVP020FSEFD	622,22
	25	LKVP025FDED	406,93	LKVP025FSED	437,63	LKVP025FDEFD	607,58	LKVP025FSEFD	648,85
	32	LKVP032FDED	444,63	LKVP032FSED	475,32	LKVP032FDEFD	645,24	LKVP032FSEFD	686,55
	40	LKVP040FDED	498,26	LKVP040FSED	588,59	LKVP040FDEFD	698,91	LKVP040FSEFD	799,85
ROSCAR	50	LKVP050FDED	601,50	LKVP050FSED	734,96	LKVP050FDEFD	802,09	LKVP050FSEFD	946,19
	63	LKVP063FDED	685,91	LKVP063FSED	819,40	LKVP063FDEFD	886,55	LKVP063FSEFD	1.030,65
ENCOLAR	3/8"	LKVP038FDED	388,13	LKVP038FSED	418,85	LKVP038FDEFD	588,75	LKVP038FSEFD	630,08
	1/2"	LKVP012FDED	391,04	LKVP012FSED	421,73	LKVP012FDEFD	591,68	LKVP012FSEFD	632,99
	3/4"	LKVP034FDED	419,29	LKVP034FSED	450,01	LKVP034FDEFD	619,94	LKVP034FSEFD	661,21
	1"	LKVP100FDED	459,98	LKVP100FSED	490,69	LKVP100FDEFD	660,59	LKVP100FSEFD	701,89
	1 1/4"	LKVP114FDED	737,89	LKVP114FSED	607,16	LKVP114FDEFD	717,43	LKVP114FSEFD	818,37
ROSCAR	1 1/2"	LKVP112FDED	624,00	LKVP112FSED	757,49	LKVP112FDEFD	824,62	LKVP112FSEFD	968,69
	2"	LKVP200FDED	714,23	LKVP200FSED	847,72	LKVP200FDEFD	914,85	LKVP200FSEFD	1.058,92

Válvula de bola motorizada en PVC-U 3 vías DUAL BLOCK®.

Actuación neumática.

Estándar paso en L, paso en T opcional, al mismo precio. Disponemos de otras conexiones bajo pedido: bridas, encolar (BS, ASTM, JIS) y roscar (NPT, JIS). Las válvulas neumáticas se configuran NC (normalmente cerrada) de serie. La configuración NA (normalmente abierta) se debe especificar en el pedido.

LKDIV/CP

encolar.

LKDFV/CP

roscar.

ACTUACIÓN NEUMÁTICA POLIAMIDA

ACTUACIÓN NEUMÁTICA POLIAMIDA CON ELECTROVÁLVULA, FINALES DE CARRERA (ELECTROMECÁNICOS) Y REGULADORES DE ESCAPE



d-Rh	DOBLE EFECTO €		SIMPLE EFECTO €		DOBLE EFECTO €		SIMPLE EFECTO €	
	Ref.	Ref.	Ref.	Ref.	Ref.	Ref.	Ref.	
16	LKVP016EDEP	420,68	LKVP016ESEP	443,83	LKVP016EDEFP	683,13	LKVP016ESEFP	706,27
20	LKVP020EDEP	423,07	LKVP020ESEP	446,23	LKVP020EDEFP	685,52	LKVP020ESEFP	708,69
25	LKVP025EDEP	489,77	LKVP025ESEP	512,92	LKVP025EDEFP	752,21	LKVP025ESEFP	775,33
32	LKVP032EDEP	522,52	LKVP032ESEP	649,75	LKVP032EDEFP	784,99	LKVP032ESEFP	912,22
40	LKVP040EDEP	579,66	LKVP040ESEP	828,33	LKVP040EDEFP	842,11	LKVP040ESEFP	1.090,77
50	LKVP050EDEP	715,21	LKVP050ESEP	868,42	LKVP050EDEFP	977,62	LKVP050ESEFP	1.130,89
63	LKVP063EDEP	859,57	LKVP063ESEP	926,07	LKVP063EDEFP	1.122,01	LKVP063ESEFP	1.188,52

3/8"	LKVP038EDEP	431,24	LKVP038ESEP	454,36	LKVP038EDEFP	693,65	LKVP038ESEFP	716,78
1/2"	LKVP012EDEP	433,82	LKVP012ESEP	456,94	LKVP012EDEFP	696,23	LKVP012ESEFP	719,38
3/4"	LKVP034EDEP	502,16	LKVP034ESEP	525,28	LKVP034EDEFP	764,57	LKVP034ESEFP	787,72
1"	LKVP100EDEP	537,90	LKVP100ESEP	665,12	LKVP100EDEFP	800,34	LKVP100ESEFP	927,57
1 1/4"	LKVP114EDEP	598,25	LKVP114ESEP	846,97	LKVP114EDEFP	860,70	LKVP114ESEFP	1.109,39
1 1/2"	LKVP112EDEP	737,67	LKVP112ESEP	890,90	LKVP112EDEFP	1.000,11	LKVP112ESEFP	1.153,34
2"	LKVP200EDEP	887,91	LKVP200ESEP	954,43	LKVP200EDEFP	1.150,39	LKVP200ESEFP	1.216,87

16	LKVP016FDEP	435,74	LKVP016FSEP	458,90	LKVP016FDEFP	698,19	LKVP016FSEFP	721,34
20	LKVP020FDEP	438,45	LKVP020FSEP	461,59	LKVP020FDEFP	700,86	LKVP020FSEFP	724,04
25	LKVP025FDEP	510,26	LKVP025FSEP	533,42	LKVP025FDEFP	772,71	LKVP025FSEFP	795,86
32	LKVP032FDEP	547,96	LKVP032FSEP	675,20	LKVP032FDEFP	810,43	LKVP032FSEFP	937,66
40	LKVP040FDEP	616,49	LKVP040FSEP	865,20	LKVP040FDEFP	878,95	LKVP040FSEFP	1.127,62
50	LKVP050FDEP	776,96	LKVP050FSEP	930,22	LKVP050FDEFP	1.039,40	LKVP050FSEFP	1.192,64
63	LKVP063FDEP	937,56	LKVP063FSEP	1.004,04	LKVP063FDEFP	1.200,00	LKVP063FSEFP	1.266,49

3/8"	LKVP038FDEP	446,28	LKVP038FSEP	469,40	LKVP038FDEFP	708,72	LKVP038FSEFP	731,87
1/2"	LKVP012FDEP	449,21	LKVP012FSEP	472,36	LKVP012FDEFP	711,66	LKVP012FSEFP	734,80
3/4"	LKVP034FDEP	522,65	LKVP034FSEP	545,80	LKVP034FDEFP	785,10	LKVP034FSEFP	808,24
1"	LKVP100FDEP	563,34	LKVP100FSEP	690,56	LKVP100FDEFP	825,75	LKVP100FSEFP	953,01
1 1/4"	LKVP114FDEP	635,05	LKVP114FSEP	883,74	LKVP114FDEFP	897,47	LKVP114FSEFP	1.146,16
1 1/2"	LKVP112FDEP	799,49	LKVP112FSEP	952,70	LKVP112FDEFP	1.061,91	LKVP112FSEFP	1.215,17
2"	LKVP200FDEP	965,83	LKVP200FSEP	1.032,37	LKVP200FDEFP	1.228,28	LKVP200FSEFP	1.294,79

Válvula de bola motorizada en PVC-U 3 vías DUAL BLOCK®.

Actuación neumática.

Estándar paso en L, paso en T opcional, al mismo precio. Disponemos de otras conexiones bajo pedido: bridas, encolar (BS, ASTM, JIS) y roscar (NPT, JIS).

Las válvulas neumáticas se configuran NC (normalmente cerrada) de serie. La configuración NA (normalmente abierta) se debe especificar en el pedido.



FEOV/CE

d	ACTUACIÓN ELÉCTRICA				ACTUACIÓN ELÉCTRICA CON BLOQUE DE SEGURIDAD			
	24-240 V AC/DC Ref.	€ EPDM	24-240 V AC/DC Ref.	€ FKM	24-240 V AC/DC Ref.	€ EPDM	24-240 V AC/DC Ref.	€ FKM
50	FEVE050E2D	666,18	FEVE050F2D	764,31	FEVE050E2BD	1.220,84	FEVE050F2BD	1.318,97
63	FEVE063E2D	671,90	FEVE063F2D	776,21	FEVE063E2BD	1.226,55	FEVE063F2BD	1.330,89
75	FEVE075E2D	936,06	FEVE075F2D	1.038,60	FEVE075E2BD	1.490,72	FEVE075F2BD	1.593,26
90	FEVE090E2D	951,93	FEVE090F2D	1.087,35	FEVE090E2BD	1.506,58	FEVE090F2BD	1.642,03
110	FEVE110E2D	973,50	FEVE110F2D	1.150,15	FEVE110E2BD	1.528,19	FEVE110F2BD	1.704,84
125 (A1)	FEVE140E2D	1.364,39	FEVE140F2D	1.620,65	FEVE140E2BD	1.919,10	FEVE140F2BD	2.175,34
140	FEVE140E2D	1.364,39	FEVE140F2D	1.620,65	FEVE140E2BD	1.919,10	FEVE140F2BD	2.175,34
160	FEVE160E2D	1.650,21	FEVE160F2D	2.057,82	FEVE160E2BD	2.299,30	FEVE160F2BD	2.706,92
200*(A2)	FEVE225E2D	1.936,53	FEVE225F2D	2.464,31	FEVE225E2BD	2.585,64	FEVE225F2BD	3.113,38
225*	FEVE225E2D	1.936,53	FEVE225F2D	2.464,31	FEVE225E2BD	2.585,64	FEVE225F2BD	3.113,38
250*(A3)	FEVE280E2D	2.750,82			FEVE280E2BD	3.399,91		
280	FEVE280E2D	2.750,82			FEVE280E2BD	3.399,91		
315	FEVE315E2D	3.022,02			FEVE315E2BD	3.671,11		

Válvula de mariposa motorizada en PVC-U.

Actuación eléctrica.

(A1) = a utilizar con portabridas QPV especial no incluido (transforma la válvula de mariposa de 140 en 125)

(A2) = a utilizar con portabridas QPV especial no incluido (transforma la válvula de mariposa de 225 en 200)

(A3) = a utilizar con tubo de diámetro 250 SDR 26 (PN10).

Bajo pedido podemos suministrar otros actuadores: VALPES, BELIMO... [Bajo pedido también disponibles en 12V AC/DC](#)



FEOV/CP

ACTUACIÓN NEUMÁTICA ALUMINIO

ACTUACIÓN NEUMÁTICA ALUMINIO CON ELECTROVÁLVULA, FINALES DE CARRERA (ELECTROMECAÑICOS) Y REGULADORES DE ESCAPE

d	DOBLE EFECTO		SIMPLE EFECTO		DOBLE EFECTO		SIMPLE EFECTO	
	Ref.	€	Ref.	€	Ref.	€	Ref.	€
50	FEVP050EDED	328,45	FEVP050ESED	418,80	FEVP050EDEFD	529,11	FEVP050ESEFD	630,00
63	FEVP063EDED	334,16	FEVP063ESED	424,55	FEVP063EDEFD	534,78	FEVP063ESEFD	635,77
75	FEVP075EDED	374,46	FEVP075ESED	507,94	FEVP075EDEFD	575,05	FEVP075ESEFD	719,15
90	FEVP090EDED	452,87	FEVP090ESED	572,61	FEVP090EDEFD	653,51	FEVP090ESEFD	783,83
110	FEVP110EDED	474,47	FEVP110ESED	925,23	FEVP110EDEFD	675,11	FEVP110ESEFD	1.136,45
125 (A1)	FEVP140EDED	532,23	FEVP140ESED	1.209,61	FEVP140EDEFD	732,82	FEVP140ESEFD	1.420,83
140	FEVP140EDED	532,23	FEVP140ESED	1.209,61	FEVP140EDEFD	732,82	FEVP140ESEFD	1.420,83
160	FEVP160EDED	576,08	FEVP160ESED	1.253,49	FEVP160EDEFD	776,72	FEVP160ESEFD	1.464,71
200 (A2)	FEVP225EDED	1.001,37	FEVP225ESED	1.931,04	FEVP225EDEFD	1.201,99	FEVP225ESEFD	2.142,28
225	FEVP225EDED	1.001,37	FEVP225ESED	1.931,04	FEVP225EDEFD	1.201,99	FEVP225ESEFD	2.142,28
250 (A3)	FEVP280EDED	1.996,53	FEVP280ESED	3.967,49	FEVP280EDEFD	2.197,18	FEVP280ESEFD	4.178,74
280	FEVP280EDED	1.996,53	FEVP280ESED	3.967,49	FEVP280EDEFD	2.197,18	FEVP280ESEFD	4.178,74
315	FEVP315EDED	2.535,81	FEVP315ESED	5.256,91	FEVP315EDEFD	2.736,40	FEVP315ESEFD	5.468,15
50	FEVP050FDED	426,57	FEVP050FSED	516,94	FEVP050FDEFD	627,22	FEVP050FSEFD	728,16
63	FEVP063FDED	438,50	FEVP063FSED	528,83	FEVP063FDEFD	639,15	FEVP063FSEFD	740,06
75	FEVP075FDED	476,99	FEVP075FSED	610,48	FEVP075FDEFD	677,64	FEVP075FSEFD	821,68
90	FEVP090FDED	588,28	FEVP090FSED	708,05	FEVP090FDEFD	788,93	FEVP090FSEFD	919,25
110	FEVP110FDED	651,09	FEVP110FSED	1.101,84	FEVP110FDEFD	851,74	FEVP110FSEFD	1.313,07
125 (A1)	FEVP140FDED	788,50	FEVP140FSED	1.465,88	FEVP140FDEFD	989,09	FEVP140FSEFD	1.677,10
140	FEVP140FDED	788,50	FEVP140FSED	1.465,88	FEVP140FDEFD	989,09	FEVP140FSEFD	1.677,10
160	FEVP160FDED	983,73	FEVP160FSED	1.661,11	FEVP160FDEFD	1.184,35	FEVP160FSEFD	1.872,33
200 (A2)	FEVP225FDED	1.529,09	FEVP225FSED	2.458,80	FEVP225FDEFD	1.729,73	FEVP225FSEFD	2.670,02
225	FEVP225FDE	2.183,16	FEVP225FSED	2.458,80	FEVP225FDEFD	1.729,73	FEVP225FSEFD	2.670,02

Válvula de mariposa motorizada en PVC-U.

Actuación neumática.

(A1) = a utilizar con portabridas QPV especial no incluido (transforma la válvula de mariposa de 140 en 125)

(A2) = a utilizar con portabridas QPV especial no incluido (transforma la válvula de mariposa de 225 en 200)

(A3)= a utilizar con tubo de diámetro 250 SDR 26 (PN10)

Las válvulas neumáticas se configuran NC (normalmente cerrada) de serie. La configuración NA (normalmente abierta) se debe especificar en el pedido.



FEOV/CP

ACTUACIÓN NEUMÁTICA POLIAMIDA

ACTUACIÓN NEUMÁTICA POLIAMIDA CON ELECTROVÁLVULA, FINALES DE CARRERA (ELECTROMECAÑICOS) Y REGULADORES DE ESCAPE

d	DOBLE EFECTO		SIMPLE EFECTO		DOBLE EFECTO		SIMPLE EFECTO	
	Ref.	€	Ref.	€	Ref.	€	Ref.	€
50	FEVP050EDEP	435,41	FEVP050ESEP	598,56	FEVP050EDEFP	697,83	FEVP050ESEFP	860,98
63	FEVP063EDEP	441,13	FEVP063ESEP	604,28	FEVP063EDEFP	703,57	FEVP063ESEFP	866,72
75	FEVP075EDEP	445,68	FEVP075ESEP	608,81	FEVP075EDEFP	708,10	FEVP075ESEFP	871,26
90	FEVP090EDEP	557,83	FEVP090ESEP	624,33	FEVP090EDEFP	820,27	FEVP090ESEFP	886,76
110	FEVP110EDEP	579,43	FEVP110ESEP	841,18	FEVP110EDEFP	841,87	FEVP110ESEFP	1.103,65
125 (A1)	FEVP140EDEP	595,89	FEVP140ESEP	1.157,77	FEVP140EDEFP	858,33	FEVP140ESEFP	1.420,22
140	FEVP140EDEP	595,89	FEVP140ESEP	1.157,77	FEVP140EDEFP	858,33	FEVP140ESEFP	1.420,22
160	FEVP160EDEP	823,36	FEVP160ESEP	1.201,63	FEVP160EDEFP	1.085,77	FEVP160ESEFP	1.464,07
200 (A2)	FEVP225EDEP	982,72	FEVP225ESEP	1.763,41	FEVP225EDEFP	1.245,15	FEVP225ESEFP	2.025,89
225	FEVP225EDEP	982,72	FEVP225ESEP	1.763,41	FEVP225EDEFP	1.245,15	FEVP225ESEFP	2.025,89
250*(A3)	FEVP280EDEP	2.175,24	FEVP280ESEP	3.848,73	FEVP280EDEFP	2.437,63	FEVP280ESEFP	4.111,19
280*	FEVP280EDEP	2.175,24	FEVP280ESEP	3.848,73	FEVP280EDEFP	2.437,63	FEVP280ESEFP	4.111,19
315*	FEVP315EDEP	2.446,40	FEVP315ESEP	4.119,95	FEVP315EDEFP	2.708,88	FEVP315ESEFP	4.382,37

50	FEVP050FDEP	533,54	FEVP050FSEP	696,69	FEVP050FDEFP	795,96	FEVP050FSEFP	959,14
63	FEVP063FDEP	545,47	FEVP063FSEP	708,62	FEVP063FDEFP	807,91	FEVP063FSEFP	971,06
75	FEVP075FDEP	548,20	FEVP075FSEP	711,35	FEVP075FDEFP	810,64	FEVP075FSEFP	973,81
90	FEVP090FDEP	693,27	FEVP090FSEP	759,78	FEVP090FDEFP	955,72	FEVP090FSEFP	1.022,20
110	FEVP110FDEP	756,02	FEVP110FSEP	1.017,79	FEVP110FDEFP	1.018,49	FEVP110FSEFP	1.280,24
125 (A1)	FEVP140FDEP	852,12	FEVP140FSEP	1.414,01	FEVP140FDEFP	1.114,56	FEVP140FSEFP	1.676,46
140	FEVP140FDEP	852,12	FEVP140FSEP	1.414,01	FEVP140FDEFP	1.114,56	FEVP140FSEFP	1.676,46
160	FEVP160FDEP	1.230,95	FEVP160FSEP	1.609,27	FEVP160FDEFP	1.493,43	FEVP160FSEFP	1.871,72
200 (A2)	FEVP225FDEP	1.510,47	FEVP225FSEP	2.291,16	FEVP225FDEFP	1.772,92	FEVP225FSEFP	2.553,61
225	FEVP225FDEP	1.510,47	FEVP225FSEP	2.291,16	FEVP225FDEFP	1.772,92	FEVP225FSEFP	2.553,61

Válvula de mariposa motorizada en PVC-U.

Actuación neumática.

(A1) = a utilizar con portabridas QPV especial no incluido (transforma la válvula de mariposa de 140 en 125)

(A2) = a utilizar con portabridas QPV especial no incluido (transforma la válvula de mariposa de 225 en 200)

(A3)= a utilizar con tubo de diámetro 250 SDR 26 (PN10) * Actuadores de aluminio

Las válvulas neumáticas se configuran NC (normalmente cerrada) de serie. La configuración NA (normalmente abierta) se debe especificar en el pedido.



FKOV/CE

ACTUACIÓN ELÉCTRICA

ACTUACIÓN ELÉCTRICA CON BLOQUE DE SEGURIDAD

d	24-240 V AC/DC		24-240 V AC/DC		24-240 V AC/DC		24-240 V AC/DC	
	Ref.	€	Ref.	€	Ref.	€	Ref.	€
50	FKVE050E2D	845,01	FKVE050F2D	1.011,59	FKVE050E2BD	1.399,70	FKVE050F2BD	1.566,30
63	FKVE063E2D	862,42	FKVE063F2D	1.038,81	FKVE063E2BD	1.417,10	FKVE063F2BD	1.593,51
75	FKVE075E2D	1.156,90	FKVE075F2D	1.352,91	FKVE075E2BD	1.711,58	FKVE075F2BD	1.907,54
90	FKVE090E2D	1.187,44	FKVE090F2D	1.392,15	FKVE090E2BD	1.742,12	FKVE090F2BD	1.946,78
110	FKVE110E2D	1.219,26	FKVE110F2D	1.440,02	FKVE110E2BD	1.773,97	FKVE110F2BD	1.994,68
125 (A1)	FKVE140E2D	1.720,23	FKVE140F2D	2.019,32	FKVE140E2BD	2.274,89	FKVE140F2BD	2.574,02
140	FKVE140E2D	1.720,23	FKVE140F2D	2.019,32	FKVE140E2BD	2.274,89	FKVE140F2BD	2.574,02
160	FKVE160E2D	2.020,24	FKVE160F2D	2.329,48	FKVE160E2BD	2.669,33	FKVE160F2BD	2.978,55
200(A2)	FKVE225E2D	2.341,24	FKVE225F2D	2.744,88	FKVE225E2BD	2.990,33	FKVE225F2BD	3.393,98
225	FKVE225E2D	2.341,24	FKVE225F2D	2.744,88	FKVE225E2BD	2.990,33	FKVE225F2BD	3.393,98
250(A3)	FKVE280E2D	4.125,05	FKVE280F2D	5.818,24	FKVE280E2BD	4.774,13	FKVE280F2BD	6.467,32
280	FKVE280E2D	4.125,05	FKVE280F2D	5.818,24	FKVE280E2BD	4.774,13	FKVE280F2BD	6.467,32
315	FKVE315E2D	4.350,15	FKVE315F2D	6.195,84	FKVE315E2BD	4.999,24	FKVE315F2BD	6.844,92
355	FKVE355E2D	11.017,40	FKVE355F2D	14.976,49				
400	FKVE400E2D	12.210,55	FKVE400F2D	17.929,76				

Válvula de mariposa industrial motorizada.

Cuerpo en PPGR y disco en PVC-U.

Actuación eléctrica.

(A1) = a utilizar con portabridas QPV especial no incluido (transforma la válvula de mariposa de 140 en 125)

(A2) = a utilizar con portabridas QPV especial no incluido (transforma la válvula de mariposa de 225 en 200)

(A3) = a utilizar con tubo de diámetro 250 SDR 26 (PN10)

Bajo pedido podemos suministrar otros actuadores: VALPES, BELIMO...

Bajo pedido también disponibles en 12V AC/DC



FKOV/CP

ACTUACIÓN NEUMÁTICA ALUMINIO

ACTUACIÓN NEUMÁTICA ALUMINIO CON ELECTROVÁLVULA, FINALES DE CARRERA (ELECTROMECAÑICOS) Y REGULADORES DE ESCAPE

d	DOBLE EFECTO		SIMPLE EFECTO		DOBLE EFECTO		SIMPLE EFECTO	
	Ref.	€	Ref.	€	Ref.	€	Ref.	€
50	FKVP050EDED	507,31	FKVP050ESED	597,64	FKVP050EDEFD	707,92	FKVP050ESEFD	808,89
63	FKVP063EDED	524,73	FKVP063ESED	615,06	FKVP063EDEFD	725,36	FKVP063ESEFD	826,30
75	FKVP075EDED	595,29	FKVP075ESED	728,78	FKVP075EDEFD	795,91	FKVP075ESEFD	939,98
90	FKVP090EDED	688,38	FKVP090ESED	808,12	FKVP090EDEFD	889,02	FKVP090ESEFD	1.019,37
110	FKVP110EDED	720,23	FKVP110ESED	1.171,01	FKVP110EDEFD	920,87	FKVP110ESEFD	1.382,24
125 (A1)	FKVP140EDED	888,05	FKVP140ESED	1.565,45	FKVP140EDEFD	1.088,69	FKVP140ESEFD	1.776,65
140	FKVP140EDED	888,05	FKVP140ESED	1.565,45	FKVP140EDEFD	1.088,69	FKVP140ESEFD	1.776,65
160	FKVP160EDED	946,14	FKVP160ESED	1.623,52	FKVP160EDEFD	1.146,75	FKVP160ESEFD	1.834,72
200 (A2)	FKVP225EDED	1.406,03	FKVP225ESED	2.335,71	FKVP225EDEFD	1.606,65	FKVP225ESEFD	2.546,96
225	FKVP225EDED	1.406,03	FKVP225ESED	2.335,71	FKVP225EDEFD	1.606,65	FKVP225ESEFD	2.546,96
250 (A3)	FKVP280EDED	3.370,78	FKVP280ESED	5.341,77	FKVP280EDEFD	3.571,40	FKVP280ESEFD	5.552,99
280	FKVP280EDED	3.370,78	FKVP280ESED	5.341,77	FKVP280EDEFD	3.571,40	FKVP280ESEFD	5.552,99
315	FKVP315EDED	3.863,94	FKVP315ESED	6.585,05	FKVP315EDEFD	4.064,57	FKVP315ESEFD	6.796,25
355	FKVP355EDED	6.285,55	FKVP355ESED	8.336,13				
400	FKVP400EDED	6.942,10	FKVP400ESED	10.843,84				

50	FKVP050FDED	673,91	FKVP050FSED	764,24	FKVP050FDEFD	874,50	FKVP050FSEFD	975,46
63	FKVP063FDED	701,12	FKVP063FSED	791,45	FKVP063FDEFD	901,71	FKVP063FSEFD	1.002,68
75	FKVP075FDED	791,28	FKVP075FSED	924,79	FKVP075FDEFD	991,89	FKVP075FSEFD	1.135,99
90	FKVP090FDED	893,09	FKVP090FSED	1.012,83	FKVP090FDEFD	1.093,71	FKVP090FSEFD	1.224,03
110	FKVP110FDED	940,99	FKVP110FSED	1.391,74	FKVP110FDEFD	1.141,60	FKVP110FSEFD	1.602,97
125 (A1)	FKVP140FDED	1.187,16	FKVP140FSED	1.864,54	FKVP140FDEFD	1.387,77	FKVP140FSEFD	2.075,76
140	FKVP140FDED	1.187,16	FKVP140FSED	1.864,54	FKVP140FDEFD	1.387,77	FKVP140FSEFD	2.075,76
160	FKVP160FDED	1.255,39	FKVP160FSED	1.932,77	FKVP160FDEFD	1.456,01	FKVP160FSEFD	2.144,00
200 (A2)	FKVP225FDED	1.809,71	FKVP225FSED	2.739,39	FKVP225FDEFD	2.010,33	FKVP225FSEFD	2.950,62
225	FKVP225FDED	1.809,71	FKVP225FSED	2.739,39	FKVP225FDEFD	2.010,33	FKVP225FSEFD	2.950,62
250 (A3)	FKVP280FDED	5.063,97	FKVP280FSED	7.034,93	FKVP280FDEFD	5.264,59	FKVP280FSEFD	7.246,15
280	FKVP280FDED	5.063,97	FKVP280FSED	7.034,93	FKVP280FDEFD	5.264,59	FKVP280FSEFD	7.246,15
315	FKVP315FDED	5.709,63	FKVP315FSED	8.430,74	FKVP315FDEFD	5.910,24	FKVP315FSEFD	8.641,94
355	FKVP355FDED	10.244,64	FKVP355FSED	12.295,24				
400	FKVP400FDED	12.661,33	FKVP400FSED	16.563,05				

Válvula de mariposa industrial motorizada.

Cuerpo en PPGR y disco en PVC-U.

Actuación neumática.

(A1) = a utilizar con portabridas QPV especial no incluido (transforma la válvula de mariposa de 140 en 125)

(A2) = a utilizar con portabridas QPV especial no incluido (transforma la válvula de mariposa de 225 en 200)

(A3) = a utilizar con tubo de diámetro 250 SDR 26 (PN10)

Las válvulas neumáticas se configuran NC (normalmente cerrada) de serie. La configuración NA (normalmente abierta) se debe especificar en el pedido.



FKOV/CP

ACTUACIÓN NEUMÁTICA POLIAMIDA

ACTUACIÓN NEUMÁTICA POLIAMIDA CON ELECTROVÁLVULA, FINALES DE CARRERA (ELECTROMECÁNICOS) Y REGULADORES DE ESCAPE

d	DOBLE EFECTO		SIMPLE EFECTO		DOBLE EFECTO		SIMPLE EFECTO	
	Ref.	€	Ref.	€	Ref.	€	Ref.	€
50	FKVP050EDEP	614,24	FKVP050ESEP	777,44	FKVP050EDEF	876,72	FKVP050ESEFP	1.039,89
63	FKVP063EDEP	631,68	FKVP063ESEP	794,83	FKVP063EDEF	894,09	FKVP063ESEFP	1.057,27
75	FKVP075EDEP	666,51	FKVP075ESEP	829,67	FKVP075EDEF	928,96	FKVP075ESEFP	1.092,09
90	FKVP090EDEP	793,34	FKVP090ESEP	859,84	FKVP090EDEF	1.055,78	FKVP090ESEFP	1.122,32
110	FKVP110EDEP	825,22	FKVP110ESEP	1.086,94	FKVP110EDEF	1.087,63	FKVP110ESEFP	1.349,40
125 (A1)	FKVP140EDEP	951,67	FKVP140ESEP	1.513,59	FKVP140EDEF	1.214,14	FKVP140ESEFP	1.776,03
140	FKVP140EDEP	951,67	FKVP140ESEP	1.513,59	FKVP140EDEF	1.214,14	FKVP140ESEFP	1.776,03
160	FKVP160EDEP	1.193,39	FKVP160ESEP	1.571,68	FKVP160EDEF	1.455,83	FKVP160ESEFP	1.834,10
200 (A2)	FKVP225EDEP	1.387,41	FKVP225ESEP	2.168,10	FKVP225EDEF	1.649,85	FKVP225ESEFP	2.430,54
225	FKVP225EDEP	1.387,41	FKVP225ESEP	2.168,10	FKVP225EDEF	1.649,85	FKVP225ESEFP	2.430,54
250*(A3)	FKVP280EDEP	3.549,48	FKVP280ESEP	5.222,98	FKVP280EDEF	3.811,93	FKVP280ESEFP	5.485,42
280*	FKVP280EDEP	3.549,48	FKVP280ESEP	5.222,98	FKVP280EDEF	3.811,93	FKVP280ESEFP	5.485,42
315*	FKVP315EDEP	3.774,57	FKVP315ESEP	5.448,08	FKVP315EDEF	4.036,98	FKVP315ESEFP	5.710,53
355	FKVP355EDEP	Consultar	FKVP355ESEP	Consultar				
400	FKVP400EDEP	Consultar	FKVP400ESEP	Consultar				

50	FKVP050FDEP	780,87	FKVP050FSEP	944,03	FKVP050FDEF	1.043,29	FKVP050FSEFP	1.206,47
63	FKVP063FDEP	808,07	FKVP063FSEP	971,22	FKVP063FDEF	1.070,51	FKVP063FSEFP	1.233,66
75	FKVP075FDEP	862,47	FKVP075FSEP	1.025,62	FKVP075FDEF	1.124,95	FKVP075FSEFP	1.288,10
90	FKVP090FDEP	998,05	FKVP090FSEP	1.064,54	FKVP090FDEF	1.260,46	FKVP090FSEFP	1.326,98
110	FKVP110FDEP	1.045,91	FKVP110FSEP	1.307,67	FKVP110FDEF	1.308,36	FKVP110FSEFP	1.570,11
125 (A1)	FKVP140FDEP	1.250,78	FKVP140FSEP	1.812,70	FKVP140FDEF	1.513,22	FKVP140FSEFP	2.075,12
140	FKVP140FDEP	1.250,78	FKVP140FSEP	1.812,70	FKVP140FDEF	1.513,22	FKVP140FSEFP	2.075,12
160	FKVP160FDEP	1.502,65	FKVP160FSEP	1.880,91	FKVP160FDEF	1.765,09	FKVP160FSEFP	2.143,36
200 (A2)	FKVP225FDEP	1.791,07	FKVP225FSEP	2.571,79	FKVP225FDEF	2.053,51	FKVP225FSEFP	2.834,23
225	FKVP225FDEP	1.791,07	FKVP225FSEP	2.571,79	FKVP225FDEF	2.053,51	FKVP225FSEFP	2.834,23
250*(A3)	FKVP280FDEP	5.242,65	FKVP280FSEP	6.916,17	FKVP280FDEF	5.505,09	FKVP280FSEFP	7.178,62
280*	FKVP280FDEP	5.242,65	FKVP280FSEP	6.916,17	FKVP280FDEF	5.505,09	FKVP280FSEFP	7.178,62
315*	FKVP315FDEP	5.620,25	FKVP315FSEP	7.293,77	FKVP315FDEF	5.882,67	FKVP315FSEFP	7.556,18
355	FKVP355FDEP	Consultar	FKVP355FSEP	Consultar				
400	FKVP400FDEP	Consultar	FKVP400FSEP	Consultar				

Válvula de mariposa industrial motorizada.

Cuerpo en PPGR y disco en PVC-U.

Actuación neumática.

(A1) = a utilizar con portabridas QPV especial no incluido (transforma la válvula de mariposa de 140 en 125)

(A2) = a utilizar con portabridas QPV especial no incluido (transforma la válvula de mariposa de 225 en 200)

(A3) = a utilizar con tubo de diámetro 250 SDR 26 (PN10) * Actuadores de aluminio

Las válvulas neumáticas se configuran NC (normalmente cerrada) de serie.

La configuración NA (normalmente abierta) se debe especificar en el pedido.



INDUSTRIA

Válvulas motorizadas de PVC-U presión

Válvulas de membrana actuadas

**DK/CP NC****VM/CP NC**

d	Modelo	DN	Ref. EPDM	€ EPDM	Ref. FKM	€ FKM	Ref. PTFE	€ PTFE
20	DKDV/CP NC	15	DKDVNC020E	344,95	DKDVNC020F	403,97	DKDVNC020P	428,46
25	DKDV/CP NC	20	DKDVNC025E	362,18	DKDVNC025F	423,59	DKDVNC025P	449,34
32	DKDV/CP NC	25	DKDVNC032E	443,47	DKDVNC032F	517,11	DKDVNC032P	546,00
40	DKDV/CP NC	32	DKDVNC040E	590,79	DKDVNC040F	712,09	DKDVNC040P	743,92
50	DKDV/CP NC	40	DKDVNC050E	670,38	DKDVNC050F	801,58	DKDVNC050P	837,52
63	DKDV/CP NC	50	DKDVNC063E	939,08	DKDVNC063F	1.162,51	DKDVNC063P	1.156,28
75	VMDV/CP NC	65	VMDVNC075E	1.126,87	VMDVNC075F	1.395,51	VMDVNC075P	1.387,56
90	VMDV/CP NC	80	VMDVNC090E	1.723,07	VMDVNC090F	2.296,57	VMDVNC090P	1.991,79
110	VMDV/CP NC	100	VMDVNC110E	2.130,25	VMDVNC110F	2.677,12	VMDVNC110P	2.384,24

Válvula neumática **NORMALMENTE CERRADA.**

M-M encolar

DK/CP NO**VM/CP NO**

d	Modelo	DN	Ref. EPDM	€ EPDM	Ref. FKM	€ FKM	Ref. PTFE	€ PTFE
20	DKDV/CP NO	15	DKDVNO020E	283,02	DKDVNO020F	342,01	DKDVNO020P	366,56
25	DKDV/CP NO	20	DKDVNO025E	300,22	DKDVNO025F	361,63	DKDVNO025P	387,38
32	DKDV/CP NO	25	DKDVNO032E	373,99	DKDVNO032F	482,95	DKDVNO032P	516,24
40	DKDV/CP NO	32	DKDVNO040E	389,34	DKDVNO040F	545,80	DKDVNO040P	586,74
50	DKDV/CP NO	40	DKDVNO050E	444,10	DKDVNO050F	624,67	DKDVNO050P	670,99
63	DKDV/CP NO	50	DKDVNO063E	590,43	DKDVNO063F	872,51	DKDVNO063P	864,43
75	DKDV/CP NO	65	DKDVNO075E	708,49	DKDVNO075F	1.047,00	DKDVNO075P	1.037,29
90	VMDV/CP NO	80	VMDVNO090E	1.149,72	VMDVNO090F	1.827,04	VMDVNO090P	1.466,39
110	VMDV/CP NO	100	VMDVNO110E	1.750,18	VMDVNO110F	2.480,22	VMDVNO110P	2.060,36

Válvula neumática **NORMALMENTE ABIERTA.**

M-M encolar

DK/CP DE**VM/CP DE**

d	Modelo	DN	Ref. EPDM	€ EPDM	Ref. FKM	€ FKM	Ref. PTFE	€ PTFE
20	DKDV/CP DE	15	DKDVDA020E	221,12	DKDVDA020F	280,11	DKDVDA020P	304,62
25	DKDV/CP DE	20	DKDVDA025E	238,32	DKDVDA025F	299,76	DKDVDA025P	325,51
32	DKDV/CP DE	25	DKDVDA032E	325,30	DKDVDA032F	427,17	DKDVDA032P	458,64
40	DKDV/CP DE	32	DKDVDA040E	353,91	DKDVDA040F	496,15	DKDVDA040P	533,39
50	DKDV/CP DE	40	DKDVDA050E	293,83	DKDVDA050F	401,26	DKDVDA050P	431,04
63	DKDV/CP DE	50	DKDVDA063E	379,26	DKDVDA063F	560,45	DKDVDA063P	555,26
75	DKDV/CP DE	65	DKDVDA075E	455,09	DKDVDA075F	672,56	DKDVDA075P	666,31
90	VMDV/CP DE	80	VMDVDA090E	1.434,84	VMDVDA090F	2.112,17	VMDVDA090P	1.751,49
110	VMDV/CP DE	100	VMDVDA110E	2.023,88	VMDVDA110F	2.554,38	VMDVDA110P	2.334,03

Válvula neumática **DOBLE EFECTO.**

M-M encolar

**DK/CP NC**

d	Modelo	DN	Ref. EPDM	€ EPDM	Ref. FKM	€ FKM	Ref. PTFE	€ PTFE
20	DKUIV/CP NC	15	DKUIVNC020E	346,27	DKUIVNC020F	421,09	DKUIVNC020P	451,81
25	DKUIV/CP NC	20	DKUIVNC025E	365,86	DKUIVNC025F	434,64	DKUIVNC025P	476,41
32	DKUIV/CP NC	25	DKUIVNC032E	452,12	DKUIVNC032F	548,92	DKUIVNC032P	584,99
40	DKUIV/CP NC	32	DKUIVNC040E	600,90	DKUIVNC040F	753,96	DKUIVNC040P	791,56
50	DKUIV/CP NC	40	DKUIVNC050E	695,35	DKUIVNC050F	867,21	DKUIVNC050P	910,93
63	DKUIV/CP NC	50	DKUIVNC063E	965,71	DKUIVNC063F	1.239,09	DKUIVNC063P	1.231,67

Válvula neumática **NORMALMENTE CERRADA.**

Con enlaces H-H para encolar.

**DK/CP NO**

d	Modelo	DN	Ref. EPDM	€ EPDM	Ref. FKM	€ FKM	Ref. PTFE	€ PTFE
20	DKUIV/CP NO	15	DKUIVNO020E	284,33	DKUIVNO020F	359,16	DKUIVNO020P	389,91
25	DKUIV/CP NO	20	DKUIVNO025E	303,95	DKUIVNO025F	372,71	DKUIVNO025P	414,47
32	DKUIV/CP NO	25	DKUIVNO032E	398,15	DKUIVNO032F	517,30	DKUIVNO032P	471,23
40	DKUIV/CP NO	32	DKUIVNO040E	433,99	DKUIVNO040F	603,51	DKUIVNO040P	651,94
50	DKUIV/CP NO	40	DKUIVNO050E	525,97	DKUIVNO050F	719,40	DKUIVNO050P	773,79
63	DKUIV/CP NO	50	DKUIVNO063E	678,87	DKUIVNO063F	989,37	DKUIVNO063P	979,30

Válvula neumática **NORMALMENTE ABIERTA.**

Con enlaces H-H para encolar.

**DK/CP DE**

d	Modelo	DN	Ref. EPDM	€ EPDM	Ref. FKM	€ FKM	Ref. PTFE	€ PTFE
20	DKUIV/CP DE	15	DKUIVDA020E	222,43	DKUIVDA020F	297,24	DKUIVDA020P	327,98
25	DKUIV/CP DE	20	DKUIVDA025E	242,03	DKUIVDA025F	310,78	DKUIVDA025P	352,52
32	DKUIV/CP DE	25	DKUIVDA032E	347,50	DKUIVDA032F	458,87	DKUIVDA032P	501,80
40	DKUIV/CP DE	32	DKUIVDA040E	394,54	DKUIVDA040F	548,61	DKUIVDA040P	592,66
50	DKUIV/CP DE	40	DKUIVDA050E	464,21	DKUIVDA050F	634,94	DKUIVDA050P	838,98
63	DKUIV/CP DE	50	DKUIVDA063E	599,14	DKUIVDA063F	873,24	DKUIVDA063P	864,34

Válvula neumática **DOBLE EFECTO.**

Con enlaces H-H para encolar.



DK/CP NC

Rh	Modelo	DN	Ref. EPDM	€ EPDM	Ref. FKM	€ FKM	Ref. PTFE	€ PTFE
½"	DKUFV/CP NC	15	DKUFVNC012E	346,27	DKUFVNC012F	421,09	DKUFVNC012P	451,81
¾"	DKUFV/CP NC	20	DKUFVNC034E	365,86	DKUFVNC034F	434,64	DKUFVNC034P	476,41
1"	DKUFV/CP NC	25	DKUFVNC100E	452,12	DKUFVNC100F	548,92	DKUFVNC100P	584,99
1¼"	DKUFV/CP NC	32	DKUFVNC114E	600,90	DKUFVNC114F	753,96	DKUFVNC114P	791,56
1½"	DKUFV/CP NC	40	DKUFVNC112E	695,35	DKUFVNC112F	867,21	DKUFVNC112P	884,39
2"	DKUFV/CP NC	50	DKUFVNC200E	945,88	DKUFVNC200F	1.239,09	DKUFVNC200P	1.195,80

Válvula neumática **NORMALMENTE CERRADA.**

Con enlaces H-H para roscar.



DK/CP NO

Rh	Modelo	DN	Ref. EPDM	€ EPDM	Ref. FKM	€ FKM	Ref. PTFE	€ PTFE
½"	DKUFV/CP NO	15	DKUFVNO012E	284,33	DKUFVNO012F	359,16	DKUFVNO012P	389,91
¾"	DKUFV/CP NO	20	DKUFVNO034E	303,95	DKUFVNO034F	372,71	DKUFVNO034P	414,47
1"	DKUFV/CP NO	25	DKUFVNO100E	398,15	DKUFVNO100F	517,30	DKUFVNO100P	471,23
1¼"	DKUFV/CP NO	32	DKUFVNO114E	433,99	DKUFVNO114F	603,51	DKUFVNO114P	651,94
1½"	DKUFV/CP NO	40	DKUFVNO112E	525,97	DKUFVNO112F	719,40	DKUFVNO112P	773,79
2"	DKUFV/CP NO	50	DKUFVNO200E	678,87	DKUFVNO200F	989,37	DKUFVNO200P	979,30

Válvula neumática **NORMALMENTE ABIERTA.**

Con enlaces H-H para roscar.



DK/CP DE

Rh	Modelo	DN	Ref. EPDM	€ EPDM	Ref. FKM	€ FKM	Ref. PTFE	€ PTFE
½"	DKUFV/CP DE	15	DKUFVDA012E	222,43	DKUFVDA012F	297,24	DKUFVDA012P	327,98
¾"	DKUFV/CP DE	20	DKUFVDA034E	242,03	DKUFVDA034F	310,78	DKUFVDA034P	352,52
1"	DKUFV/CP DE	25	DKUFVDA100E	347,50	DKUFVDA100F	458,87	DKUFVDA100P	501,80
1¼"	DKUFV/CP DE	32	DKUFVDA114E	394,54	DKUFVDA114F	548,61	DKUFVDA114P	592,66
1½"	DKUFV/CP DE	40	DKUFVDA112E	464,21	DKUFVDA112F	634,94	DKUFVDA112P	682,96
2"	DKUFV/CP DE	50	DKUFVDA200E	599,14	DKUFVDA200F	873,24	DKUFVDA200P	864,34

Válvula neumática **DOBLE EFECTO.**

Con enlaces H-H para roscar.

DK/CP NC



d	Modelo	DN	Ref. EPDM	€ EPDM
20	DKOV/CP NC	15	DKOVNC020E	396,70
25	DKOV/CP NC	20	DKOVNC025E	416,48
32	DKOV/CP NC	25	DKOVNC032E	510,00
40	DKOV/CP NC	32	DKOVNC040E	679,42
50	DKOV/CP NC	40	DKOVNC050E	770,96
63	DKOV/CP NC	50	DKOVNC063E	1.079,96
75	DKOV/CP NC	65	DKOVNC075E	1.295,95
90	VMOV/CP NC	80	VMOVNC090E	1.981,60
110	VMOV/CP NC	100	VMOVNC110E	2.449,80

VM/CP NC



Ref. FKM	€ FKM	Ref. PTFE	€ PTFE
DKOVNC020F	455,67	DKOVNC020P	480,22
DKOVNC025F	477,90	DKOVNC025P	503,65
DKOVNC032F	583,63	DKOVNC032P	612,49
DKOVNC040F	800,67	DKOVNC040P	832,53
DKOVNC050F	902,18	DKOVNC050P	938,10
DKOVNC063F	1.303,41	DKOVNC063P	1.297,16
DKOVNC075F	1.564,09	DKOVNC075P	1.556,59
VMOVNC090F	2.555,00	VMOVNC090P	2.250,27
VMOVNC110F	2.995,70	VMOVNC110P	2.703,52

Válvula neumática **NORMALMENTE CERRADA.**

Con bridas DIN.

Disponibles con bridas ANSI 150 libras al mismo precio

DK/CP NO



d	Modelo	DN	Ref. EPDM	€ EPDM
20	DKOV/CP NO	15	DKOVNO020E	334,75
25	DKOV/CP NO	20	DKOVNO025E	354,58
32	DKOV/CP NO	25	DKOVNO032E	449,88
40	DKOV/CP NO	32	DKOVNO040E	486,81
50	DKOV/CP NO	40	DKOVNO050E	568,05
63	DKOV/CP NO	50	DKOVNO063E	745,39
75	DKOV/CP NO	65	DKOVNO075E	894,45
90	VMOV/CP NO	80	VMOVNO090E	1.408,20
110	VMOV/CP NO	100	VMOVNO110E	1.992,10

VM/CP NO



Ref. FKM	€ FKM	Ref. PTFE	€ PTFE
DKOVNO020F	393,72	DKOVNO020P	418,31
DKOVNO025F	415,97	DKOVNO025P	441,75
DKOVNO032F	558,78	DKOVNO032P	486,68
DKOVNO040F	643,21	DKOVNO040P	684,16
DKOVNO050F	735,35	DKOVNO050P	781,65
DKOVNO063F	1.027,48	DKOVNO063P	1.019,39
DKOVNO075F	1.232,96	DKOVNO075P	1.223,28
VMOVNO090F	2.085,52	VMOVNO090P	1.724,82
VMOVNO110F	2.707,08	VMOVNO110P	2.302,36

Válvula neumática **NORMALMENTE ABIERTA.**

Con bridas DIN.

Disponibles con bridas ANSI 150 libras al mismo precio

DK/CP DE



d	Modelo	DN	Ref. EPDM	€ EPDM
20	DKOV/CP DE	15	DKOVDA020E	272,85
25	DKOV/CP DE	20	DKOVDA025E	292,65
32	DKOV/CP DE	25	DKOVDA032E	396,81
40	DKOV/CP DE	32	DKOVDA040E	442,54
50	DKOV/CP DE	40	DKOVDA050E	501,38
63	DKOV/CP DE	50	DKOVDA063E	657,89
75	DKOV/CP DE	65	DKOVDA075E	789,44
90	VMOV/CP DE	80	VMOVDA090E	1.693,32
110	VMOV/CP DE	100	VMOVDA110E	2.265,82

VM/CP DE



Ref. FKM	€ FKM	Ref. PTFE	€ PTFE
DKOVDA020F	331,81	DKOVDA020P	356,38
DKOVDA025F	354,06	DKOVDA025P	379,81
DKOVDA032F	498,62	DKOVDA032P	530,09
DKOVDA040F	584,76	DKOVDA040P	621,97
DKOVDA050F	649,03	DKOVDA050P	649,03
DKOVDA063F	906,86	DKOVDA063P	906,86
DKOVDA075F	1.088,24	DKOVDA075P	1.088,24
VMOVDA090F	2.370,65	VMOVDA090P	2.009,89
VMOVDA110F	2.766,07	VMOVDA110P	2.576,01

Válvula neumática **DOBLE EFECTO.**

Con bridas DIN.

Disponibles con bridas ANSI 150 libras al mismo precio

CMDV/CP NC *M-M encolar.*
CMIV/CP NC *H-H encolar.*
CMUIV/CP NC *H-H enlaces encolar.*
CMFV/CP NC *H-H roscar.*

d-Rh	Ref. EPDM	DN	€ EPDM	€ FKM	€ PTFE
20	CMDVNC020E	15	166,07	189,21	209,43
16	CMIVNC016E	12	155,99	184,92	197,86
20	CMIVNC020E	15	155,99	184,92	197,86
20-1/2"	CMUIVNC020E	15	213,81	235,46	254,20
3/8"	CMFVNC038E	12	155,99	184,92	197,86
1/2"	CMFVNC012E	15	155,99	184,92	197,86

Válvula de membrana compacta neumática
NORMALMENTE CERRADA

Código en FKM termina en "F" en lugar de "E"
 Código en PTFE termina en "P" en lugar de "E"
 (A) = Juntas en FKM

CMDV/CP NO *M-M encolar.*
CMIV/CP NO *H-H encolar.*
CMUIV/CP NO *H-H enlaces encolar.*
CMFV/CP NO *H-H roscar.*

d-Rh	Ref. EPDM	DN	€ EPDM	€ FKM	€ PTFE
20	CMDVNO020E	15	163,20	186,33	205,12
16	CMIVNO016E	12	154,58	179,12	194,96
20	CMIVNO020E	15	154,58	179,12	194,96
20-1/2"	CMUIVNO020E	15	212,37	231,11	251,32
3/8"	CMFVNO038E	12	154,58	179,12	194,96
1/2"	CMFVNO012E	15	154,58	179,12	194,96

Válvula de membrana compacta neumática
NORMALMENTE ABIERTA

Código en FKM termina en "F" en lugar de "E"
 Código en PTFE termina en "P" en lugar de "E"
 (A) = Juntas en FKM

CMDV/CP DE *M-M encolar.*
CMIV/CP DE *H-H encolar.*
CMUIV/CP DE *H-H enlaces encolar.*
CMFV/CP DE *H-H roscar.*

d-Rh	Ref. EPDM	DN	€ EPDM	€ FKM	€ PTFE
20	CMDVDA020E	15	163,20	186,33	205,12
16	CMIVDA016E	12	154,58	179,12	194,96
20	CMIVDA020E	15	154,58	179,12	194,96
20-1/2"	CMUIVDA020E	15	212,37	231,11	251,32
3/8"	CMFVDA038E	12	154,58	179,12	194,96
1/2"	CMFVDA012E	15	154,58	179,12	194,96

Válvula de membrana compacta neumática
DOBLE EFECTO

Código en FKM termina en "F" en lugar de "E"
 Código en PTFE termina en "P" en lugar de "E"
 (A) = Juntas en FKM

DKDDV/CP NO

d	Ref. EPDM	DN	PN	€ EPDM
20	DKDDVNO020E	15	8	95,28
25	DKDDVNO025E	20	8	111,24
32	DKDDVNO032E	25	8	122,78
40	DKDDVNO040E	32	8	141,55
50	DKDDVNO050E	40	8	173,30
63	DKDDVNO063E	50	8	186,33
75	DKDDVNO075E	65	8	223,59

Válvula de membrana normalmente abierta acción directa.

Disponible embrizada
 Precios: Consultar

Membrana en EPDM. M-M encolar.

DKDUIV/CP NO

d	Ref. EPDM	DN	PN	€ EPDM
20	DKDUIVNO020E	15	8	112,66
25	DKDUIVNO025E	20	8	129,97
32	DKDUIVNO032E	25	8	147,34
40	DKDUIVNO040E	32	8	176,26
50	DKDUIVNO050E	40	8	235,59
63	DKDUIVNO063E	50	8	242,62

Válvula de membrana normalmente abierta acción directa.
 Membrana en EPDM. H-H enlaces encolar.

DKDUFV/CP NO

Rh	Ref. EPDM	DN	PN	€ EPDM
1/2"	DKDUFVNO012E	15	8	122,78
3/4"	DKDUFVNO034E	20	8	140,13
1"	DKDUFVNO100E	25	8	160,32
1 1/4"	DKDUFVNO114E	32	8	206,55
1 1/2"	DKDUFVNO112E	40	8	254,20
2"	DKDUFVNO200E	50	8	278,77

Válvula de membrana normalmente abierta acción directa.
 Membrana en EPDM. H-H enlaces roscar.

DKBDV/CP NC

d	Ref. EPDM	DN	PN	€ EPDM
20	DKBDVNC020E	15	6	311,58
25	DKBDVNC025E	20	6	327,15
32	DKBDVNC032E	25	6	419,16
40	DKBDVNC040E	32	6	527,41
50	DKBDVNC050E	40	6	553,24
63	DKBDVNC063E	50	6	774,97
75	DKBDVNC075E	65	6	929,97

Válvula de membrana neumática
Normalmente Cerrada.

M-M encolar.

Actuador a pistón

DKBUIV/CP NC

d	Ref. EPDM	DN	PN	€ EPDM
20	DKBUIVNC020E	15	6	312,76
25	DKBUIVNC025E	20	6	271,27
32	DKBUIVNC032E	25	6	427,35
40	DKBUIVNC040E	32	6	536,48
50	DKBUIVNC050E	40	6	573,79
63	DKBUIVNC063E	50	6	796,89

Válvula de membrana neumática
Normalmente Cerrada.

Con enlaces H-H encolar.

Actuador a pistón

DKBUFV/CP NC

Rh	Ref. EPDM	DN	PN	€ EPDM
½"	DKBUFVNC012E	15	6	312,76
¾"	DKBUFVNC034E	20	6	330,46
1"	DKBUFVNC100E	25	6	427,35
1 ¼"	DKBUFVNC114E	32	6	536,48
1 ½"	DKBUFVNC112E	40	6	573,79
2"	DKBUFVNC200E	50	6	796,89

Válvula de membrana neumática
Normalmente Cerrada.

Con enlaces H-H para roscar.

Actuador a pistón

DKBOV/CP NC

d	Ref. EPDM	DN	PN	€ EPDM
20	DKBOVNC020E	15	6	358,34
25	DKBOVNC025E	20	6	376,19
32	DKBOVNC032E	25	6	491,13
40	DKBOVNC040E	32	6	623,25
50	DKBOVNC050E	40	6	653,77
63	DKBOVNC063E	50	6	915,88
75	DKBOVNC075E	65	6	1.190,63

Válvula de membrana neumática
Normalmente Cerrada.

Con bridas DIN.

Actuador a pistón

DKBOAV/CP NC

d	Ref. EPDM	DN	PN	€ EPDM
½"	DKBOAVNC012E	15	6	358,34
¾"	DKBOAVNC034E	20	6	376,19
1"	DKBOAVNC100E	25	6	476,80
1 ¼"	DKBOAVNC114E	32	6	605,10
1 ½"	DKBOAVNC112E	40	6	634,73
2"	DKBOAVNC200E	50	6	889,20
2 ½"	DKBOAVNC212E	65	6	1.155,95

Válvula de membrana neumática
Normalmente Cerrada.

Con bridas ANSI 150 lbs.

Actuador a pistón



Válvulas motorizadas de PVC-U presión

Válvulas de control de presión



SVUIV

d - Rh	Ref.	DN	PN	€ EPDM	€ FKM
20 - 1/2"	SVUIV020E	15	16	190,84	195,89
25 - 3/4"	SVUIV025E	20	16	204,49	211,34
32 - 1"	SVUIV032E	25	16	219,75	226,60

Válvula de sobrepresión seguridad.
Con enlaces H-H
para encolar (rosacar bajo pedido).

Código en FKM termina en "F" en lugar de "E"
Rango de calibración: 0,3 - 4 bars



VPR

d	Ref.	DN	PN	€ EPDM	€ FKM
16	VPRDV016E	10	10	969,16	1.003,53
20	VPRDV020E	15	10	969,16	1.003,53
25	VPRDV025E	20	10	1.233,68	1.288,46
32	VPRDV032E	25	10	1.233,68	1.288,46
40	VPRDV040E	32	10	1.484,98	1.551,18
50	VPRDV050E	40	10	1.484,98	1.551,18
63	VPRDV063E	50	10	2.101,54	2.166,86

Válvula reductora de presión.
M-M encolar.

Código en FKM termina en "F" en lugar de "E"
Rango de calibración: 0,5 - 9 bars



VSF

d	Ref.	EPDM	DN	PN	€ EPDM	€ PTFE
16	VSFDV016E	10	10	379,14	435,02	
20	VSFDV020E	15	10	441,44	468,32	
25	VSFDV025E	20	10	493,63	535,60	
32	VSFDV032E	25	10	521,95	562,02	
40	VSFDV040E	32	10	655,42	718,12	
50	VSFDV050E	40	10	1.253,92	1.304,65	
63	VSFDV063E	50	10	1.473,34	1.520,23	
75	VSFDV075E	65	10	1.978,63	2.073,88	
90	VSFDV090E	80	10	3.315,55	3.471,62	
110	VSFDV110E	100	10	4.766,15	4.957,03	

Válvula de sobrepresión-alivio.
M-M encolar.

Código en PTFE termina en "P" en lugar de "E"
Rango de calibración: 0,5 - 10 bars



VCP

d	Ref.	EPDM	DN	PN	€ EPDM	€ PTFE
16	VCPDV016E	10	10	344,33	368,51	
20	VCPDV020E	15	10	348,14	383,62	
25	VCPDV025E	20	10	464,12	504,22	
32	VCPDV032E	25	10	495,51	548,78	
40	VCPDV040E	32	10	633,09	679,99	
50	VCPDV050E	40	10	1.197,46	1.241,44	
63	VCPDV063E	50	10	1.281,73	1.308,13	

Válvula retenedora de presión.
M-M encolar.

Código en PTFE termina en "P" en lugar de "E"
Rango de calibración: 0,5 - 10 bars

Flujómetros / rotámetros
Medidores electrónicos de caudal
Electrodos de pH y ORP
Sensores y transmisores de conductividad
Accesorios y recambios



0803

Medición

INDUSTRIA



Más información







FCIV
 encolar.

FLOTADOR INOX AISI 316

Diámetro Encolar	Ref. Encolar	Escala l/h.	€
16	FC16D1X0030	3-30	151,05
16	FC16D1X0040	4-40	151,05
16	FC16D1X0100	10-100	151,05
16	FC16D1X0200	20-200	151,05
16	FC16D1X0300	30-300	151,05
20	FC20D1X0050	5-50	158,74
20	FC20D1X0100	10-100	158,74
20	FC20D1X0160	15-160	158,74
20	FC20D1X0250	20-250	158,74
20	FC20D1X0350	35-350	158,74
20	FC20D1X0600	60-600	158,74
25	FC25D1X0150	15-150	166,41
25	FC25D1X0250	25-250	166,41
25	FC25D1X0400	40-400	166,41
25	FC25D1X0600	50-600	166,41
25	FC25D1X1100	100-1100	166,41
32	FC32D1X0400	40-400	184,35
32	FC32D1X0600	50-600	184,35
32	FC32D1X1000	100-1000	184,35
32	FC32D1X1500	150-1500	184,35

FLOTADOR PP ROJO

16	FC16D1M0015	1,5-15	151,05
16	FC16D1M0020	2-20	151,05
16	FC16D1M0050	5-50	151,05
16	FC16D1M0100	10-100	151,05
16	FC16D1M0150	15-150	151,05
20	FC20D1M0025	2-25	158,74
20	FC20D1M0050	5-50	158,74
20	FC20D1M0100	10-100	158,74
20	FC20D1M0150	15-150	158,74
20	FC20D1M0200	20-200	158,74
20	FC20D1M0320	30-320	158,74
25	FC25D1M0080	8-80	166,41
25	FC25D1M0150	15-150	166,41
25	FC25D1M0200	20-200	166,41
25	FC25D1M0350	30-350	166,41
25	FC25D1M0650	50-650	166,41
32	FC32D1M0200	20-200	184,35
32	FC32D1M0300	30-300	184,35
32	FC32D1M0600	60-600	184,35
32	FC32D1M1000	100-1000	184,35

 Flujómetro corto para H₂O.

Densidad: 1 kg/l - 20° C. Cuerpo: TROGAMID. Juntas: EPDM.

FCIV
 encolar.

FLOTADOR INOX AISI 316 CON IMÁN INTERIOR incorporado para contacto exterior (suministrado aparte)

Diámetro Encolar	Ref. Encolar	Escala l/h.	€
16	FC16D1X0030M	3-30	227,87
16	FC16D1X0040M	4-40	227,87
16	FC16D1X0100M	10-100	227,87
16	FC16D1X0200M	20-200	227,87
16	FC16D1X0300M	30-300	227,87
20	FC20D1X0050M	5-50	233,00
20	FC20D1X0100M	10-100	233,00
20	FC20D1X0160M	15-160	233,00
20	FC20D1X0250M	20-250	233,00
20	FC20D1X0350M	35-350	233,00
20	FC20D1X0600M	60-600	233,00
25	FC25D1X0150M	15-150	243,24
25	FC25D1X0250M	25-250	243,24
25	FC25D1X0400M	40-400	243,24
25	FC25D1X0600M	50-600	243,24
25	FC25D1X1100M	100-1100	243,24
32	FC32D1X0400M	40-400	273,96
32	FC32D1X0600M	50-600	273,96
32	FC32D1X1000M	100-1000	273,96
32	FC32D1X1500M	150-1500	273,96

FLOTADOR PP ROJO CON IMÁN INTERIOR incorporado para contacto exterior (suministrado aparte)

16	FC16D1M0015M	1,5-15	227,87
16	FC16D1M0020M	2-20	227,87
16	FC16D1M0050M	5-50	227,87
16	FC16D1M0100M	10-100	227,87
16	FC16D1M0150M	15-150	227,87
20	FC20D1M0025M	2-25	233,00
20	FC20D1M0050M	5-50	233,00
20	FC20D1M0100M	10-100	233,00
20	FC20D1M0150M	15-150	233,00
20	FC20D1M0200M	20-200	233,00
20	FC20D1M0320M	30-320	233,00
25	FC25D1M0080M	8-80	243,24
25	FC25D1M0150M	15-150	243,24
25	FC25D1M0200M	20-200	243,24
25	FC25D1M0350M	30-350	243,24
25	FC25D1M0650M	50-650	243,24
32	FC32D1M0200M	20-200	273,96
32	FC32D1M0300M	30-300	273,96
32	FC32D1M0600M	60-600	273,96
32	FC32D1M1000M	100-1000	273,96

Flujómetro corto para H₂O.

Densidad: 1 kg/l - 20° C. Cuerpo: TROGAMID. Juntas: EPDM.

FCIV
 encolar.

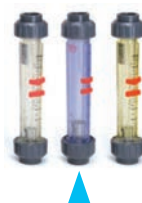

FLOTADOR INOX AISI 316

Diámetro Encolar	Ref. Encolar	Escala l/h.	€
16	FC16T1X0030	3-30	145,92
16	FC16T1X0040	4-40	145,92
16	FC16T1X0100	10-100	145,92
16	FC16T1X0200	20-200	145,92
16	FC16T1X0300	30-300	145,92
20	FC20T1X0050	5-50	153,63
20	FC20T1X0100	10-100	153,63
20	FC20T1X0160	15-160	153,63
20	FC20T1X0250	20-250	153,63
20	FC20T1X0350	35-350	153,63
20	FC20T1X0600	60-600	153,63
25	FC25T1X0150	15-150	161,33
25	FC25T1X0250	25-250	161,33
25	FC25T1X0400	40-400	161,33
25	FC25T1X0600	50-600	161,33
25	FC25T1X1100	100-1100	161,33
32	FC32T1X0400	40-400	179,24
32	FC32T1X0600	50-600	179,24
32	FC32T1X1000	100-1000	179,24
32	FC32T1X1500	150-1500	179,24

FLOTADOR PP ROJO

16	FC16T1M0015	1,5-15	145,92
16	FC16T1M0020	2-20	145,92
16	FC16T1M0050	5-50	145,92
16	FC16T1M0100	10-100	145,92
16	FC16T1M0150	15-150	145,92
20	FC20T1M0025	2-25	153,63
20	FC20T1M0050	5-50	153,63
20	FC20T1M0100	10-100	153,63
20	FC20T1M0150	15-150	153,63
20	FC20T1M0200	20-200	153,63
20	FC20T1M0320	30-320	153,63
25	FC25T1M0080	8-80	161,33
25	FC25T1M0150	15-150	161,33
25	FC25T1M0200	20-200	161,33
25	FC25T1M0350	30-350	161,33
25	FC25T1M0650	50-650	161,33
32	FC32T1M0200	20-200	179,24
32	FC32T1M0300	30-300	179,24
32	FC32T1M0600	60-600	179,24
32	FC32T1M1000	100-1000	179,24

Flujómetro corto para H₂O.

Densidad: 1 kg/l - 20° C. Cuerpo: PVC Transparente. Juntas: EPDM.

FCIV
 encolar.

FLOTADOR INOX AISI 316 CON IMÁN INTERIOR incorporado para contacto exterior (suministrado aparte)

Diámetro Encolar	Ref. Encolar	Escala l/h.	€
16	FC16T1X0030M	3-30	222,72
16	FC16T1X0040M	4-40	222,72
16	FC16T1X0100M	10-100	222,72
16	FC16T1X0200M	20-200	222,72
16	FC16T1X0300M	30-300	222,72
20	FC20T1X0050M	5-50	227,87
20	FC20T1X0100M	10-100	227,87
20	FC20T1X0160M	15-160	227,87
20	FC20T1X0250M	20-250	227,87
20	FC20T1X0350M	35-350	227,87
20	FC20T1X0600M	60-600	227,87
25	FC25T1X0150M	15-150	238,13
25	FC25T1X0250M	25-250	238,13
25	FC25T1X0400M	40-400	238,13
25	FC25T1X0600M	50-600	238,13
25	FC25T1X1100M	100-1100	238,13
32	FC32T1X0400M	40-400	268,83
32	FC32T1X0600M	50-600	268,83
32	FC32T1X1000M	100-1000	268,83
32	FC32T1X1500M	150-1500	268,83

FLOTADOR PP ROJO CON IMÁN INTERIOR incorporado para contacto exterior (suministrado aparte)

16	FC16T1M0015M	1,5-15	222,72
16	FC16T1M0020M	2-20	222,72
16	FC16T1M0050M	5-50	222,72
16	FC16T1M0100M	10-100	222,72
16	FC16T1M0150M	15-150	222,72
20	FC20T1M0025M	2-25	227,87
20	FC20T1M0050M	5-50	227,87
20	FC20T1M0100M	10-100	227,87
20	FC20T1M0150M	15-150	227,87
20	FC20T1M0200M	20-200	227,87
20	FC20T1M0320M	30-320	227,87
25	FC25T1M0080M	8-80	238,13
25	FC25T1M0150M	15-150	238,13
25	FC25T1M0200M	20-200	238,13
25	FC25T1M0350M	30-350	238,13
25	FC25T1M0650M	50-650	238,13
32	FC32T1M0200M	20-200	268,83
32	FC32T1M0300M	30-300	268,83
32	FC32T1M0600M	60-600	268,83
32	FC32T1M1000M	100-1000	268,83

 Flujómetro corto para H₂O.

Densidad: 1 kg/l - 20° C. Cuerpo: PVC Transparente. Juntas: EPDM.

FCIV
 encolar.



FLOTADOR INOX AISI 316

Diámetro Encolar	Ref. Encolar	Escala l/h.	€
16	FC16P1X0030	3-30	166,41
16	FC16P1X0040	4-40	166,41
16	FC16P1X0100	10-100	166,41
16	FC16P1X0200	20-200	166,41
16	FC16P1X0300	30-300	166,41
20	FC20P1X0050	5-50	176,68
20	FC20P1X0100	10-100	176,68
20	FC20P1X0160	15-160	176,68
20	FC20P1X0250	20-250	176,68
20	FC20P1X0350	35-350	176,68
20	FC20P1X0600	60-600	176,68
25	FC25P1X0150	15-150	189,47
25	FC25P1X0250	25-250	189,47
25	FC25P1X0400	40-400	189,47
25	FC25P1X0600	50-600	189,47
25	FC25P1X1100	100-1100	189,47
32	FC32P1X0400	40-400	212,54
32	FC32P1X0600	50-600	212,54
32	FC32P1X1000	100-1000	212,54
32	FC32P1X1500	150-1500	212,54

FLOTADOR PP ROJO

16	FC16P1M0015	1,5-15	166,41
16	FC16P1M0020	2-20	166,41
16	FC16P1M0050	5-50	166,41
16	FC16P1M0100	10-100	166,41
16	FC16P1M0150	15-150	166,41
20	FC20P1M0025	2-25	176,68
20	FC20P1M0050	5-50	176,68
20	FC20P1M0100	10-100	176,68
20	FC20P1M0150	15-150	176,68
20	FC20P1M0200	20-200	176,68
20	FC20P1M0320	30-320	176,68
25	FC25P1M0080	8-80	189,47
25	FC25P1M0150	15-150	189,47
25	FC25P1M0200	20-200	189,47
25	FC25P1M0350	30-350	189,47
25	FC25P1M0650	50-650	189,47
32	FC32P1M0200	20-200	212,54
32	FC32P1M0300	30-300	212,54
32	FC32P1M0600	60-600	212,54
32	FC32P1M1000	100-1000	212,54

Flujómetro corto para H₂O.

Densidad: 1 kg/l - 20° C. Cuerpo: POLYSULFON Juntas: EPDM.

FCIV
 encolar.

FLOTADOR INOX AISI 316 CON IMÁN INTERIOR incorporado para contacto exterior (suministrado aparte)

Diámetro Encolar	Ref. Encolar	Escala l/h.	€
16	FC16P1X0030M	3-30	245,81
16	FC16P1X0040M	4-40	245,81
16	FC16P1X0100M	10-100	245,81
16	FC16P1X0200M	20-200	245,81
16	FC16P1X0300M	30-300	245,81
20	FC20P1X0050M	5-50	253,47
20	FC20P1X0100M	10-100	253,47
20	FC20P1X0160M	15-160	253,47
20	FC20P1X0250M	20-250	253,47
20	FC20P1X0350M	35-350	253,47
20	FC20P1X0600M	60-600	253,47
25	FC25P1X0150M	15-150	266,29
25	FC25P1X0250M	25-250	266,29
25	FC25P1X0400M	40-400	266,29
25	FC25P1X0600M	50-600	266,29
25	FC25P1X1100M	100-1100	266,29
32	FC32P1X0400M	40-400	302,13
32	FC32P1X0600M	50-600	302,13
32	FC32P1X1000M	100-1000	302,13
32	FC32P1X1500M	150-1500	302,13

FLOTADOR PP ROJO CON IMÁN INTERIOR incorporado para contacto exterior (suministrado aparte)

16	FC16P1M0015M	1,5-15	245,81
16	FC16P1M0020M	2-20	245,81
16	FC16P1M0050M	5-50	245,81
16	FC16P1M0100M	10-100	245,81
16	FC16P1M0150M	15-150	245,81
20	FC20P1M0025M	2-25	253,47
20	FC20P1M0050M	5-50	253,47
20	FC20P1M0100M	10-100	253,47
20	FC20P1M0150M	15-150	253,47
20	FC20P1M0200M	20-200	253,47
20	FC20P1M0320M	30-320	253,47
25	FC25P1M0080M	8-80	266,29
25	FC25P1M0150M	15-150	266,29
25	FC25P1M0200M	20-200	266,29
25	FC25P1M0350M	30-350	266,29
25	FC25P1M0650M	50-650	266,29
32	FC32P1M0200M	20-200	302,13
32	FC32P1M0300M	30-300	302,13
32	FC32P1M0600M	60-600	302,13
32	FC32P1M1000M	100-1000	302,13

 Flujómetro corto para H₂O.

Densidad: 1 kg/l - 20° C. Cuerpo: POLYSULFON. Juntas: EPDM.

FCIV
 encolar.



FLOTADOR INOX AISI 316

Diámetro Encolar	Ref. Encolar	Escala l/h.	€
16	FC16T3X0085	0,5-8,5	145,92
16	FC16T3X0040	2,5-40	145,92
16	FC16T3X0120	10-120	145,92
16	FC16T3X0180	15-180	145,92
20	FC20T3X0375	2,5-37,5	153,63
20	FC20T3X0075	4-75	153,63
20	FC20T3X0140	5-140	153,63
20	FC20T3X0220	9-220	153,63
20	FC20T3X0360	24-360	153,63
25	FC25T3X0135	6-135	161,33
25	FC25T3X0230	13-230	161,33
25	FC25T3X0350	20-350	161,33
25	FC25T3X0650	25-650	161,33
32	FC32T3X0220	10-220	179,24
32	FC32T3X0350	20-350	179,24
32	FC32T3X0650	25-650	179,24
32	FC32T3X1000	50-1000	179,24

FLOTADOR PP ROJO

16	FC16T3M0003	0,25-3	145,92
16	FC16T3M0017	1-17	145,92
16	FC16T3M0045	2,5-45	145,92
16	FC16T3M0075	5-75	145,92
20	FC20T3M0125	1-12,5	153,63
20	FC20T3M0034	2-34	153,63
20	FC20T3M0063	2,5-63	153,63
20	FC20T3M0104	5-104	153,63
20	FC20T3M0170	10-170	153,63
25	FC25T3M0060	3,5-60	161,33
25	FC25T3M0092	5-92	161,33
25	FC25T3M0165	8-165	161,33
25	FC25T3M0380	20-380	161,33
32	FC32T3M0090	5-90	179,24
32	FC32T3M0150	7,5-150	179,24
32	FC32T3M0360	20-360	179,24
32	FC32T3M0650	25-650	179,24

Flujómetro corto para **Hidróxido de sodio (NaOH) 30%..**

Densidad: 1,33 kg/l - 20° C. Cuerpo **PVC Transparente**. Juntas: **EPDM**.

FCIV
 encolar.

FLOTADOR INOX AISI 316 CON IMÁN INTERIOR incorporado para contacto exterior (suministrado aparte)

Diámetro Encolar	Ref. Encolar	Escala l/h.	€
16	FC16T3X0085M	0,5-8,5	222,72
16	FC16T3X0040M	2,5-40	222,72
16	FC16T3X0120M	10-120	222,72
16	FC16T3X0180M	15-180	222,72
20	FC20T3X0375M	2,5-37,5	227,87
20	FC20T3X0075M	4-75	227,87
20	FC20T3X0140M	5-140	227,87
20	FC20T3X0220M	9-220	227,87
20	FC20T3X0360M	24-360	227,87
25	FC25T3X0135M	6-135	238,13
25	FC25T3X0230M	13-230	238,13
25	FC25T3X0350M	20-350	238,13
25	FC25T3X0650M	25-650	238,13
32	FC32T3X0220M	10-220	268,83
32	FC32T3X0350M	20-350	268,83
32	FC32T3X0650M	25-650	268,83
32	FC32T3X1000M	50-1000	268,83

FLOTADOR PP ROJO CON IMÁN INTERIOR incorporado para contacto exterior (suministrado aparte)

16	FC16T3M0003M	0,25-3	222,72
16	FC16T3M0017M	1-17	222,72
16	FC16T3M0045M	2,5-45	222,72
16	FC16T3M0075M	5-75	222,72
20	FC20T3M0125M	1-12,5	227,87
20	FC20T3M0034M	2-34	227,87
20	FC20T3M0063M	2,5-63	227,87
20	FC20T3M0104M	5-104	227,87
20	FC20T3M0170M	10-170	227,87
25	FC25T3M0060M	3,5-60	238,13
25	FC25T3M0092M	5-92	238,13
25	FC25T3M0165M	8-165	238,13
25	FC25T3M0380M	20-380	238,13
32	FC32T3M0090M	5-90	268,83
32	FC32T3M0150M	7,5-150	268,83
32	FC32T3M0360M	20-360	268,83
32	FC32T3M0650M	25-650	268,83

 Flujómetro corto para **Hidróxido de sodio (NaOH) 30%..**

 Densidad: 1,33 kg/l - 20° C. Cuerpo **PVC Transparente**. Juntas: **EPDM**.

FCIV
 encolar.

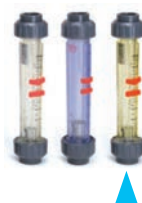

FLOTADOR INOX AISI 316

Diámetro Encolar	Ref. Encolar	Escala l/h.	€
16	FC16P3X0085	0,5-8,5	166,41
16	FC16P3X0040	2,5-40	166,41
16	FC16P3X0120	10-120	166,41
16	FC16P3X0180	15-180	166,41
20	FC20P3X0375	2,5-37,5	176,68
20	FC20P3X0075	4-75	176,68
20	FC20P3X0140	5-140	176,68
20	FC20P3X0220	9-220	176,68
20	FC20P3X0360	24-360	176,68
25	FC25P3X0135	6-135	189,47
25	FC25P3X0230	13-230	189,47
25	FC25P3X0350	20-350	189,47
25	FC25P3X0650	25-650	189,47
32	FC32P3X0220	10-220	212,54
32	FC32P3X0350	20-350	212,54
32	FC32P3X0650	25-650	212,54
32	FC32P3X1000	50-1000	212,54

FLOTADOR PP ROJO

16	FC16P3M0003	0,25-3	166,41
16	FC16P3M0017	1-17	166,41
16	FC16P3M0045	2,5-45	166,41
16	FC16P3M0075	5-75	166,41
20	FC20P3M0125	1-12,5	176,68
20	FC20P3M0034	2-34	176,68
20	FC20P3M0063	2,5-63	176,68
20	FC20P3M0104	5-104	176,68
20	FC20P3M0170	10-170	176,68
25	FC25P3M0060	3,5-60	189,47
25	FC25P3M0092	5-92	189,47
25	FC25P3M0165	8-165	189,47
25	FC25P3M0380	20-380	189,47
32	FC32P3M0090	5-90	212,54
32	FC32P3M0150	7,5-150	212,54
32	FC32P3M0360	20-360	212,54
32	FC32P3M0650	25-650	212,54

Flujómetro corto para **Hidróxido de sodio (NaOH) 30%..**

Densidad: 1,33 kg/l - 20° C. Cuerpo **POLYSULFON..** Juntas: **EPDM.**

FCIV
 encolar.



FLOTADOR INOX AISI 316 CON IMÁN INTERIOR incorporado para contacto exterior (suministrado aparte)

Diámetro Encolar	Ref. Encolar	Escala l/h.	€
16	FC16P3X0085M	0,5-8,5	245,81
16	FC16P3X0040M	2,5-40	245,81
16	FC16P3X0120M	10-120	245,81
16	FC16P3X0180M	15-180	245,81
20	FC20P3X0375M	2,5-37,5	253,47
20	FC20P3X0075M	4-75	253,47
20	FC20P3X0140M	5-140	253,47
20	FC20P3X0220M	9-220	253,47
20	FC20P3X0360M	24-360	253,47
25	FC25P3X0135M	6-135	266,29
25	FC25P3X0230M	13-230	266,29
25	FC25P3X0350M	20-350	266,29
25	FC25P3X0650M	25-650	266,29
32	FC32P3X0220M	10-220	302,13
32	FC32P3X0350M	20-350	302,13
32	FC32P3X0650M	25-650	302,13
32	FC32P3X1000M	50-1000	302,13

FLOTADOR PP ROJO CON IMÁN INTERIOR incorporado para contacto exterior (suministrado aparte)

16	FC16P3M0003M	0,25-3	245,81
16	FC16P3M0017M	1-17	245,81
16	FC16P3M0045M	2,5-45	245,81
16	FC16P3M0075M	5-75	245,81
20	FC20P3M0125M	1-12,5	253,47
20	FC20P3M0034M	2-34	253,47
20	FC20P3M0063M	2,5-63	253,47
20	FC20P3M0104M	5-104	253,47
20	FC20P3M0170M	10-170	253,47
25	FC25P3M0060M	3,5-60	266,29
25	FC25P3M0092M	5-92	266,29
25	FC25P3M0165M	8-165	266,29
25	FC25P3M0380M	20-380	266,29
32	FC32P3M0090M	5-90	302,13
32	FC32P3M0150M	7,5-150	302,13
32	FC32P3M0360M	20-360	302,13
32	FC32P3M0650M	25-650	302,13

Flujómetro corto para **Hidróxido de sodio (NaOH) 30%..**

Densidad: 1,33 kg/l - 20° C. Cuerpo **POLYSULFON**. Juntas: **EPDM**.

FCIV
 encolar.



FLOTADOR INOX AISI 316

Diámetro Encolar	Ref. Encolar	Escala l/h.	€
16	FC16T5X0014	0,05-1,4	145,92
16	FC16T5X0008	0,5-8	145,92
16	FC16T5X0040	2,5-40	145,92
16	FC16T5X0055	4-55	145,92
20	FC20T5X0065	0,25-6,5	153,63
20	FC20T5X0015	1-15	153,63
20	FC20T5X0036	2-36	153,63
20	FC20T5X0075	4-75	153,63
20	FC20T5X0140	6-140	153,63
25	FC25T5X0030	2,5-30	161,33
25	FC25T5X0065	3-65	161,33
25	FC25T5X0135	4-135	161,33
25	FC25T5X0320	20-320	161,33
32	FC32T5X0055	2,5-55	179,24
32	FC32T5X0125	5-125	179,24
32	FC32T5X0300	20-300	179,24
32	FC32T5X0600	25-600	179,24

FLOTADOR PP ROJO

16	FC16T5M0005	0,025-0,5	145,92
16	FC16T5M0275	0,25-2,75	145,92
16	FC16T5M0009	0,5-9	145,92
16	FC16T5M0021	1-21	145,92
20	FC20T5M0002	0,1-2	153,63
20	FC20T5M0055	0,25-5,5	153,63
20	FC20T5M0125	0,5-12,5	153,63
20	FC20T5M0255	2-25,5	153,63
20	FC20T5M0475	2,5-47,5	153,63
25	FC25T5M0010	1-10	161,33
25	FC25T5M0019	1-19	161,33
25	FC25T5M0045	2-45	161,33
25	FC25T5M0130	4-130	161,33
32	FC32T5M0015	1-15	179,24
32	FC32T5M0040	2-40	179,24
32	FC32T5M0110	5-110	179,24
32	FC32T5M0260	10-260	179,24

Flujómetro corto para **Hidróxido de sodio (NaOH) 50%..**

Densidad: 1,53 kg/l - 20° C. Cuerpo **PVC Transparente**. Juntas: **EPDM**.

FCIV
 encolar.



FLOTADOR INOX AISI 316 CON IMÁN INTERIOR incorporado para contacto exterior (suministrado aparte)

Diámetro Encolar	Ref. Encolar	Escala l/h.	€
16	FC16T5X0014M	0,05-1,4	222,72
16	FC16T5X0008M	0,5-8	222,72
16	FC16T5X0040M	2,5-40	222,72
16	FC16T5X0055M	4-55	222,72
20	FC20T5X0065M	0,25-6,5	227,87
20	FC20T5X0015M	1-15	227,87
20	FC20T5X0036M	2-36	227,87
20	FC20T5X0075M	4-75	227,87
20	FC20T5X0140M	6-140	227,87
25	FC25T5X0030M	2,5-30	238,13
25	FC25T5X0065M	3-65	238,13
25	FC25T5X0135M	4-135	238,13
25	FC25T5X0320M	20-320	238,13
32	FC32T5X0055M	2,5-55	268,83
32	FC32T5X0125M	5-125	268,83
32	FC32T5X0300M	20-300	268,83
32	FC32T5X0600M	25-600	268,83

FLOTADOR PP ROJO CON IMÁN INTERIOR incorporado para contacto exterior (suministrado aparte)

16	FC16T5M0005M	0,025-0,5	222,72
16	FC16T5M0275M	0,25-2,75	222,72
16	FC16T5M0009M	0,5-9	222,72
16	FC16T5M0021M	1-21	222,72
20	FC20T5M0002M	0,1-2	227,87
20	FC20T5M0055M	0,25-5,5	227,87
20	FC20T5M0125M	0,5-12,5	227,87
20	FC20T5M0255M	2-25,5	227,87
20	FC20T5M0475M	2,5-47,5	227,87
25	FC25T5M0010M	1-10	238,13
25	FC25T5M0019M	1-19	238,13
25	FC25T5M0045M	2-45	238,13
25	FC25T5M0130M	4-130	238,13
32	FC32T5M0015M	1-15	268,83
32	FC32T5M0040M	2-40	268,83
32	FC32T5M0110M	5-110	268,83
32	FC32T5M0260M	10-260	268,83

Flujómetro corto para **Hidróxido de sodio (NaOH) 50%..**

Densidad: 1,53 kg/l - 20° C. Cuerpo **PVC Transparente**. Juntas: **EPDM**.

FCIV
 encolar.

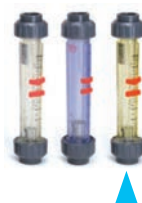

FLOTADOR INOX AISI 316

Diámetro Encolar	Ref. Encolar	Escala l/h.	€
16	FC16P5X0014	0,05-1,4	166,41
16	FC16P5X0008	0,5-8	166,41
16	FC16P5X0040	2,5-40	166,41
16	FC16P5X0055	4-55	166,41
20	FC20P5X0065	0,25-6,5	176,68
20	FC20P5X0015	1-15	176,68
20	FC20P5X0036	2-36	176,68
20	FC20P5X0075	4-75	176,68
20	FC20P5X0140	6-140	176,68
25	FC25P5X0030	2,5-30	189,47
25	FC25P5X0065	3-65	189,47
25	FC25P5X0135	4-135	189,47
25	FC25P5X0320	20-320	189,47
32	FC32P5X0055	2,5-55	212,54
32	FC32P5X0125	5-125	212,54
32	FC32P5X0300	20-300	212,54
32	FC32P5X0600	25-600	212,54

FLOTADOR PP ROJO

16	FC16P5M0005	0,025-0,5	166,41
16	FC16P5M0275	0,25-2,75	166,41
16	FC16P5M0009	0,5-9	166,41
16	FC16P5M0021	1-21	166,41
20	FC20P5M0002	0,1-2	176,68
20	FC20P5M0055	0,25-5,5	176,68
20	FC20P5M0125	0,5-12,5	176,68
20	FC20P5M0255	2-25,5	176,68
20	FC20P5M0475	2,5-47,5	176,68
25	FC25P5M0010	1-10	189,47
25	FC25P5M0019	1-19	189,47
25	FC25P5M0045	2-45	189,47
25	FC25P5M0130	4-130	189,47
32	FC32P5M0015	1-15	212,54
32	FC32P5M0040	2-40	212,54
32	FC32P5M0110	5-110	212,54
32	FC32P5M0260	10-260	212,54

Flujómetro corto para **Hidróxido de sodio (NaOH) 50%..**

Densidad: 1,53 kg/l - 20° C. Cuerpo **POLYSULFON..** Juntas: **EPDM.**

FCIV
 encolar.



FLOTADOR INOX AISI 316 CON IMÁN INTERIOR incorporado para contacto exterior (suministrado aparte)

Diámetro Encolar	Ref. Encolar	Escala l/h.	€
16	FC16P5X0014M	0,05-1,4	245,81
16	FC16P5X0008M	0,5-8	245,81
16	FC16P5X0040M	2,5-40	245,81
16	FC16P5X0055M	4-55	245,81
20	FC20P5X0065M	0,25-6,5	253,47
20	FC20P5X0015M	1-15	253,47
20	FC20P5X0036M	2-36	253,47
20	FC20P5X0075M	4-75	253,47
20	FC20P5X0140M	6-140	253,47
25	FC25P5X0030M	2,5-30	266,29
25	FC25P5X0065M	3-65	266,29
25	FC25P5X0135M	4-135	266,29
25	FC25P5X0320M	20-320	266,29
32	FC32P5X0055M	2,5-55	302,13
32	FC32P5X0125M	5-125	302,13
32	FC32P5X0300M	20-300	302,13
32	FC32P5X0600M	25-600	302,13

FLOTADOR PP ROJO CON IMÁN INTERIOR incorporado para contacto exterior (suministrado aparte)

16	FC16P5M0005M	0,025-0,5	245,81
16	FC16P5M0275M	0,25-2,75	245,81
16	FC16P5M0009M	0,5-9	245,81
16	FC16P5M0021M	1-21	245,81
20	FC20P5M0002M	0,1-2	253,47
20	FC20P5M0055M	0,25-5,5	253,47
20	FC20P5M0125M	0,5-12,5	253,47
20	FC20P5M0255M	2-25,5	253,47
20	FC20P5M0475M	2,5-47,5	253,47
25	FC25P5M0010M	1-10	266,29
25	FC25P5M0019M	1-19	266,29
25	FC25P5M0045M	2-45	266,29
25	FC25P5M0130M	4-130	266,29
32	FC32P5M0015M	1-15	302,13
32	FC32P5M0040M	2-40	302,13
32	FC32P5M0110M	5-110	302,13
32	FC32P5M0260M	10-260	302,13

Flujómetro corto para **Hidróxido de sodio (NaOH) 50%..**

Densidad: 1,53 kg/l - 20° C. Cuerpo **POLYSULFON**. Juntas: **EPDM**.

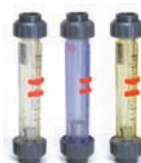
FCIV
 encolar.

FLOTADOR PP ROJO

Diámetro Encolar	Ref. Encolar	Escala l/h.	€
16	FC16T2M0014	1,4-14	151,05
16	FC16T2M0018	2-18	151,05
16	FC16T2M0045	5-45	151,05
16	FC16T2M0090	10-90	151,05
16	FC16T2M0140	14-140	151,07
20	FC20T2M0023	2-23	158,74
20	FC20T2M0045	5-45	158,74
20	FC20T2M0090	10-90	158,74
20	FC20T2M0140	14-140	158,74
20	FC20T2M0185	19-185	158,74
20	FC20T2M0300	30-300	158,74
25	FC25T2M0075	7,5-75	166,41
25	FC25T2M0140	14-140	166,41
25	FC25T2M0185	19-185	166,41
25	FC25T2M0325	30-325	166,41
25	FC25T2M0600	45-600	166,41
32	FC32T2M0185	19-185	194,60
32	FC32T2M0280	28-280	194,60
32	FC32T2M0550	55-500	194,60
32	FC32T2M0900	90-900	194,60

FLOTADOR PP ROJO CON IMÁN INTERIOR incorporado para contacto exterior (suministrado aparte)

16	FC16T2M0014M	1,4-14	227,87
16	FC16T2M0018M	2-18	227,87
16	FC16T2M0045M	5-45	227,87
16	FC16T2M0090M	10-90	227,87
16	FC16T2M0140M	14-140	227,87
20	FC20T2M0023M	2-23	233,00
20	FC20T2M0045M	5-45	233,00
20	FC20T2M0090M	10-90	233,00
20	FC20T2M0140M	14-140	233,00
20	FC20T2M0185M	19-185	233,00
20	FC20T2M0300M	30-300	233,00
25	FC25T2M0075M	7,5-75	243,24
25	FC25T2M0140M	14-140	243,24
25	FC25T2M0185M	19-185	243,24
25	FC25T2M0325M	30-325	243,24
25	FC25T2M0600M	45-600	243,24
32	FC32T2M0185M	19-185	284,21
32	FC32T2M0280M	28-280	284,21
32	FC32T2M0550M	55-500	284,21
32	FC32T2M0900M	90-900	284,21

 Flujómetro corto para **Ácido clorhídrico (HCl) 30-33%**.

 Densidad: 1.16 kg/l - 20° C. Cuerpo: **PVC Transparente**. Juntas: **EPDM**.

FCIV
 encolar.



FLOTADOR PP ROJO

Diámetro Encolar	Ref. Encolar	Escala Nm³/h	€
16	FC16D0M0025	0,025-0,25	163,91
16	FC16D0M0004	0,04-0,4	163,91
16	FC16D0M0001	0,1-1	163,91
16	FC16D0M0002	0,2-2	163,91
20	FC20D0M0045	0,045-0,45	168,99
20	FC20D0M0009	0,09-0,9	168,99
20	FC20D0M0015	0,15-1,5	168,99
20	FC20D0M0025	0,25-2,5	168,99
20	FC20D0M0038	0,38-3,8	168,99
20	FC20D0M0048	0,4-4,8	168,99
25	FC25D0M0012	0,12-1,2	179,24
25	FC25D0M0025	0,3-2,5	179,24
25	FC25D0M0045	0,45-4,5	179,24
25	FC25D0M0065	0,6-6,5	179,24
25	FC25D0M0011	1,1-11	179,24
32	FC32D0M0004	0,6-4	197,14
32	FC32D0M0007	0,7-7	197,14
32	FC32D0M0011	1,1-11	197,14
32	FC32D0M0014	2-14	197,14

Flujómetro corto para **Aire**.

Densidad: 1,013 bar abs..- 20º Cuerpo: **TROGAMID**. Juntas: **EPDM**.



Ref.	Descripción	€
MSMIN02	Contacto de MÍNIMA para diámetros 16-20-25 *	195,54
MSMAX02	Contacto de MAXIMA para diámetros 16-20-25 *	195,54
MSMIN01	Contacto de MÍNIMA para diámetros 32 *	195,54
MSMAX01	Contacto de MAXIMA para diámetros 32 *	195,54
	Escala especial	Consultar
	Doble escala	Consultar

Contactos exteriores.

Sólo utilizables con flujómetros que incorporen imán exterior.

* Para usar con flotador con imán incorporado.



d	Ref.	Descripción	€
16	QBIC016	Manguito C-PVC	10,22
20	QBIC020	Manguito C-PVC	10,17
25	QBIC025	Manguito C-PVC	11,89
32	QBIC032	Manguito C-PVC	15,45
20	QBIGM020	Manguito PP-H	4,34
25	QBIGM025	Manguito PP-H	4,39
32	QBIGM032	Manguito PP-H	4,70
20	QBIGF020	Manguito PVDF	16,80
25	QBIGF025	Manguito PVDF	21,73
32	QBIGF032	Manguito PVDF	24,22

Manguitos.

Para cada flujómetro es necesario pedir 2 manguitos.

16	EFC034	Tuerca C-PVC	8,16
20	EFC100	Tuerca C-PVC	6,80
25	EFC114	Tuerca C-PVC	7,92
32	EFC112	Tuerca C-PVC	15,26
20	EFGM100	Tuerca PP-H	8,27
25	EFGM114	Tuerca PP-H	8,56
32	EFGM112	Tuerca PP-H	9,93
20	EFGF100	Tuerca PVDF	27,71
25	EFGF114	Tuerca PVDF	37,79
32	EFGF112	Tuerca PVDF	46,88

Tuercas.

Para cada flujómetro es necesario pedir 2 tuercas.

16	OR3062F	Junta FKM	4,93
20	OR4081F	Junta FKM	15,16
25	OR4112F	Junta FKM	2,85
32	OR4131F	Junta FKM	8,05

Juntas.

Para cada flujómetro es necesario pedir 2 juntas.

Bajo pedido disponemos también de conexiones rosca hembra de 3/8" a 1" en acero inoxidable AISI 316 y en acero al carbono.

FSIV
encolar.

FLOTADOR INOX AISI 316

Diámetro Encolar	Ref. Encolar	Escala l/h.	€
25	FS25D1X0250	25-250	247,22
25	FS25D1X0400	40-400	247,22
25	FS25D1X0640	60-640	247,22
25	FS25D1X1000	100-1000	247,22
32	FS32D1X0400	40-400	281,77
32	FS32D1X0640	60-640	281,77
32	FS32D1X1000	100-1000	281,77
32	FS32D1X1600	150-1600	281,77
40	FS40D1X1600	150-1600	379,49
40	FS40D1X2500	200-2500	379,49
40	FS40D1X4000	400-4000	379,49
50	FS50D1X2500	200-2500	448,46
50	FS50D1X4000	400-4000	448,46
50	FS50D1X5000	500-5000	448,46
63	FS63D1X4000	400-4000	600,85
63	FS63D1X6000	600-6000	600,85
63	FS63D1X0010	1000-10000	600,85
75	FS75D1X0015	1500-15000	1.043,63
75	FS75D1X0020	2000-20000	1.043,63
75	FS75D1X0050	10000-50000	1.043,63

FLOTADOR PP ROJO

25	FS25D1M0150	15-150	247,22
25	FS25D1M0250	25-250	247,22
25	FS25D1M0450	45-450	247,22
25	FS25D1M0700	70-700	247,22
32	FS32D1M0250	25-250	281,77
32	FS32D1M0400	40-400	281,77
32	FS32D1M0650	65-650	281,77
32	FS32D1M1000	100-1000	281,77
40	FS40D1M1000	100-1000	379,49
40	FS40D1M1600	160-1600	379,49
40	FS40D1M2500	200-2500	379,49
50	FS50D1M1600	150-1600	448,46
50	FS50D1M2200	200-2200	448,46
50	FS50D1M2500	250-2500	448,46
63	FS63D1M2500	250-2500	600,85
63	FS63D1M3500	350-3500	600,85
63	FS63D1M5000	500-5000	600,85
75	FS75D1M8000	1000-8000	1.043,63
75	FS75D1M0010	1000-10000	1.043,63
75	FS75D1M0025	5000-25000	1.043,63

 Flujómetro largo para **H₂O**.

 Densidad: 1 kg/l - 20° C. Cuerpo: **TROGAMID**. Juntas: **EPDM**.

FSIV
 encolar.

FLOTADOR INOX AISI 316 CON IMÁN INTERIOR incorporado para contacto exterior (suministrado aparte)

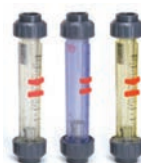

Diámetro Encolar	Ref. Encolar	Escala l/h.	€
25	FS25D1X0250M	25-250	353,65
25	FS25D1X0400M	40-400	353,65
25	FS25D1X0640M	60-640	353,65
25	FS25D1X1000M	100-1000	353,65
32	FS32D1X0400M	40-400	382,37
32	FS32D1X0640M	60-640	382,37
32	FS32D1X1000M	100-1000	382,37
32	FS32D1X1600M	150-1600	382,37
40	FS40D1X1600M	150-1600	488,75
40	FS40D1X2500M	200-2500	488,75
40	FS40D1X4000M	400-4000	488,75
50	FS50D1X2500M	200-2500	566,30
50	FS50D1X4000M	400-4000	566,30
50	FS50D1X5000M	500-5000	566,30
63	FS63D1X4000M	400-4000	735,97
63	FS63D1X6000M	600-6000	735,97
63	FS63D1X0010M	1000-10000	735,97
75	FS75D1X0015M	1500-15000	1.331,07
75	FS75D1X0020M	2000-20000	1.331,07
75	FS75D1X0050M	10000-50000	1.331,07

FLOTADOR PP ROJO CON IMÁN INTERIOR incorporado para contacto exterior (suministrado aparte)

25	FS25D1M0150M	15-150	353,65
25	FS25D1M0250M	25-250	353,65
25	FS25D1M0450M	45-450	353,65
25	FS25D1M0700M	70-700	353,65
32	FS32D1M0250M	25-250	382,37
32	FS32D1M0400M	40-400	382,37
32	FS32D1M0650M	65-650	382,37
32	FS32D1M1000M	100-1000	382,37
40	FS40D1M1000M	100-1000	488,75
40	FS40D1M1600M	160-1600	488,75
40	FS40D1M2500M	200-2500	488,75
50	FS50D1M1600M	150-1600	566,30
50	FS50D1M2200M	200-2200	566,30
50	FS50D1M2500M	250-2500	566,30
63	FS63D1M2500M	250-2500	735,97
63	FS63D1M3500M	350-3500	735,97
63	FS63D1M5000M	500-5000	735,97
75	FS75D1M8000M	1000-8000	1.331,07
75	FS75D1M0010M	1000-10000	1.331,07
75	FS75D1M0025M	5000-25000	1.331,07

Flujómetro largo para **H₂O**.

Densidad: 1 kg/l - 20° C. Cuerpo: **TROGAMID**. Juntas: **EPDM**.

FSIV

encolar.

FLOTADOR INOX AISI 316

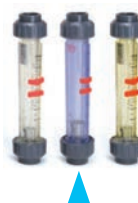

Diámetro Encolar	Ref. Encolar	Escala l/h.	€
25	FS25T1X0250	25-250	235,73
25	FS25T1X0400	40-400	235,73
25	FS25T1X0640	60-640	235,73
25	FS25T1X1000	100-1000	235,73
32	FS32T1X0400	40-400	267,37
32	FS32T1X0640	60-640	267,37
32	FS32T1X1000	100-1000	267,37
32	FS32T1X1600	150-1600	267,37
40	FS40T1X1600	150-1600	362,20
40	FS40T1X2500	200-2500	362,20
40	FS40T1X4000	400-4000	362,20
50	FS50T1X2500	200-2500	425,48
50	FS50T1X4000	400-4000	425,48
50	FS50T1X5000	500-5000	425,48
63	FS63T1X4000	400-4000	569,23
63	FS63T1X6000	600-6000	569,23
63	FS63T1X0010	1000-10000	569,23
75	FS75T1X0015	1500-15000	991,82
75	FS75T1X0020	2000-20000	991,82
75	FS75T1X0050	10000-50000	991,82

FLOTADOR PP ROJO

25	FS25T1M0150	15-150	235,73
25	FS25T1M0250	25-250	235,73
25	FS25T1M0450	45-450	235,73
25	FS25T1M0700	70-700	235,73
32	FS32T1M0250	25-250	267,37
32	FS32T1M0400	40-400	267,37
32	FS32T1M0650	65-650	267,37
32	FS32T1M1000	100-1000	267,37
40	FS40T1M1000	100-1000	362,20
40	FS40T1M1600	160-1600	362,20
40	FS40T1M2500	200-2500	362,20
50	FS50T1M1600	150-1600	425,48
50	FS50T1M2200	200-2200	425,48
50	FS50T1M2500	250-2500	425,48
63	FS63T1M2500	250-2500	569,23
63	FS63T1M3500	350-3500	569,23
63	FS63T1M5000	500-5000	569,23
75	FS75T1M8000	1000-8000	991,82
75	FS75T1M0010	1000-10000	991,82
75	FS75T1M0025	5000-25000	991,82

Flujómetro largo para H₂O.

Densidad: 1 kg/l - 20° C. Cuerpo: PVC Transparente Juntas: EPDM.

FSIV
 encolar.

FLOTADOR INOX AISI 316 CON IMÁN INTERIOR incorporado para contacto exterior (suministrado aparte)

Diámetro Encolar	Ref. Encolar	Escala l/h.	€
25	FS25T1X0250M	25-250	342,10
25	FS25T1X0400M	40-400	342,10
25	FS25T1X0640M	60-640	342,10
25	FS25T1X1000M	100-1000	342,10
32	FS32T1X0400M	40-400	368,00
32	FS32T1X0640M	60-640	368,00
32	FS32T1X1000M	100-1000	368,00
32	FS32T1X1600M	150-1600	368,00
40	FS40T1X1600M	150-1600	471,50
40	FS40T1X2500M	200-2500	471,50
40	FS40T1X4000M	400-4000	471,50
50	FS50T1X2500M	200-2500	543,39
50	FS50T1X4000M	400-4000	543,39
50	FS50T1X5000M	500-5000	543,39
63	FS63T1X4000M	400-4000	704,36
63	FS63T1X6000M	600-6000	704,36
63	FS63T1X0010M	1000-10000	704,36
75	FS75T1X0015M	1500-15000	1.279,35
75	FS75T1X0020M	2000-20000	1.279,35
75	FS75T1X0020M	10000-50000	1.279,35

FLOTADOR PP ROJO CON IMÁN INTERIOR incorporado para contacto exterior (suministrado aparte)

25	FS25T1M0150M	15-150	342,10
25	FS25T1M0250M	25-250	342,10
25	FS25T1M0450M	45-450	342,10
25	FS25T1M0700M	70-700	342,10
32	FS32T1M0250M	25-250	368,00
32	FS32T1M0400M	40-400	368,00
32	FS32T1M0650M	65-650	368,00
32	FS32T1M1000M	100-1000	368,00
40	FS40T1M1000M	100-1000	471,50
40	FS40T1M1600M	160-1600	471,50
40	FS40T1M2500M	200-2500	471,50
50	FS50T1M1600M	150-1600	543,39
50	FS50T1M2200M	200-2200	543,39
50	FS50T1M2500M	250-2500	543,39
63	FS63T1M2500M	250-2500	704,36
63	FS63T1M3500M	350-3500	704,36
63	FS63T1M5000M	500-5000	704,36
75	FS75T1M8000M	1000-8000	1.279,35
75	FS75T1M0010M	1000-10000	1.279,35
75	FS75T1M0025M	5000-25000	1.279,35

 Flujómetro largo para H₂O.

 Densidad: 1 kg/l - 20° C. Cuerpo: **PVC Transparente** Juntas: **EPDM**.

FSIV
 encolar.

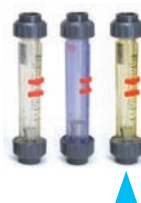

FLOTADOR INOX AISI 316

Díametro Encolar	Ref. Encolar	Escala l/h.	€
25	FS25P1X0250	25-250	307,61
25	FS25P1X0400	40-400	307,61
25	FS25P1X0640	60-640	307,61
25	FS25P1X1000	100-1000	307,61
32	FS32P1X0400	40-400	353,65
32	FS32P1X0640	60-640	353,65
32	FS32P1X1000	100-1000	353,65
32	FS32P1X1600	150-1600	353,65
40	FS40P1X1600	150-1600	457,16
40	FS40P1X2500	200-2500	457,16
40	FS40P1X4000	400-4000	457,16
50	FS50P1X2500	200-2500	560,61
50	FS50P1X4000	400-4000	560,61
50	FS50P1X5000	500-5000	560,61
63	FS63P1X4000	400-4000	750,34
63	FS63P1X6000	600-6000	750,34
63	FS63P1X0010	1000-10000	750,34
75	FS75P1X0015	1500-15000	1.305,23
75	FS75P1X0020	2000-20000	1.305,23
75	FS75P1X0050	10000-50000	1.305,23

FLOTADOR PP ROJO

25	FS25P1M0150	15-150	307,61
25	FS25P1M0250	25-250	307,61
25	FS25P1M0450	45-450	307,61
25	FS25P1M0700	70-700	307,61
32	FS32P1M0250	25-250	353,65
32	FS32P1M0400	40-400	353,65
32	FS32P1M0650	65-650	353,65
32	FS32P1M1000	100-1000	353,65
40	FS40P1M1000	100-1000	457,16
40	FS40P1M1600	160-1600	457,16
40	FS40P1M2500	200-2500	457,16
50	FS50P1M1600	150-1600	560,61
50	FS50P1M2200	200-2200	560,61
50	FS50P1M2500	250-2500	560,61
63	FS63P1M2500	250-2500	750,34
63	FS63P1M3500	350-3500	750,34
63	FS63P1M5000	500-5000	750,34
75	FS75P1M8000	1000-8000	1.305,23
75	FS75P1M0010	1000-10000	1.305,23
75	FS75P1M0025	5000-25000	1.305,23

Flujómetro largo para **H₂O**.

Densidad: 1 kg/l - 20° C. Cuerpo: **POLYSULFON**. Juntas: **EPDM**.

FSIV
 encolar.

FLOTADOR INOX AISI 316 CON IMÁN INTERIOR incorporado para contacto exterior (suministrado aparte)

Diámetro Encolar	Ref. Encolar	Escala l/h.	€
25	FS25P1X0250M	25-250	413,99
25	FS25P1X0400M	40-400	413,99
25	FS25P1X0640M	60-640	413,99
25	FS25P1X1000M	100-1000	413,99
32	FS32P1X0400M	40-400	454,23
32	FS32P1X0640M	60-640	454,23
32	FS32P1X1000M	100-1000	454,23
32	FS32P1X1600M	150-1600	454,23
40	FS40P1X1600M	150-1600	566,30
40	FS40P1X2500M	200-2500	566,30
40	FS40P1X4000M	400-4000	566,30
50	FS50P1X2500M	200-2500	678,46
50	FS50P1X4000M	400-4000	678,46
50	FS50P1X5000M	500-5000	678,46
63	FS63P1X4000M	400-4000	885,46
63	FS63P1X6000M	600-6000	885,46
63	FS63P1X0010M	1000-10000	885,46
75	FS75P1X0015M	1500-15000	1.592,72
75	FS75P1X0020M	2000-20000	1.592,72
75	FS75P1X0050M	10000-50000	1.592,72

FLOTADOR PP ROJO CON IMÁN INTERIOR incorporado para contacto exterior (suministrado aparte)

25	FS25P1M0150M	15-150	413,99
25	FS25P1M0250M	25-250	413,99
25	FS25P1M0450M	45-450	413,99
25	FS25P1M0700M	70-700	413,99
32	FS32P1M0250M	25-250	454,23
32	FS32P1M0400M	40-400	454,23
32	FS32P1M0650M	65-650	454,23
32	FS32P1M1000M	100-1000	454,23
40	FS40P1M1000M	100-1000	566,30
40	FS40P1M1600M	160-1600	566,30
40	FS40P1M2500M	200-2500	566,30
50	FS50P1M1600M	150-1600	678,46
50	FS50P1M2200M	200-2200	678,46
50	FS50P1M2500M	250-2500	678,46
63	FS63P1M2500M	250-2500	885,46
63	FS63P1M3500M	350-3500	885,46
63	FS63P1M5000M	500-5000	885,46
75	FS75P1M8000M	1000-8000	1.592,72
75	FS75P1M0010M	1000-10000	1.592,72
75	FS75P1M0025M	5000-25000	1.592,72

 Flujómetro largo para **H₂O**.

 Densidad: 1 kg/l - 20° C. Cuerpo: **POLYSULFON**. Juntas: **EPDM**.

FSIV
 encolar.

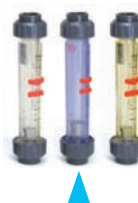

FLOTADOR INOX AISI 316

Diámetro Encolar	Ref. Encolar	Escala l/h.	€
25	FS25T3X0125	6-125	267,82
25	FS25T3X0240	10-240	267,82
25	FS25T3X0425	25-425	267,82
25	FS25T3X0725	35-725	267,82
32	FS32T3X0240	10-240	303,83
32	FS32T3X0420	20-420	303,83
32	FS32T3X0700	25-700	303,83
32	FS32T3X1200	50-1200	303,83
40	FS40T3X1150	50-1150	411,57
40	FS40T3X1900	100-1900	411,57
40	FS40T3X3200	200-3200	411,57
50	FS50T3X1700	100-1700	483,48
50	FS50T3X3000	200-3000	483,48
50	FS50T3X3700	200-3700	483,48
63	FS63T3X3000	100-3000	646,84
63	FS63T3X4700	250-4700	646,84
63	FS63T3X8500	500-8500	646,84
75	FS75T3X0012	1000-12000	1.127,02
75	FS75T3X0165	1500-16500	1.127,02
75	FS75T3X0043	8800-43000	1.127,02

FLOTADOR PP ROJO

25	FS25T3M0054	2,5-54	267,82
25	FS25T3M0115	6-115	267,82
25	FS25T3M0235	11-235	267,82
25	FS25T3M0410	28-410	267,82
32	FS32T3M0125	6-125	303,83
32	FS32T3M0100	10-100	303,83
32	FS32T3M0395	11-395	303,83
32	FS32T3M0650	25-650	303,83
40	FS40T3M0600	25-600	664,95
40	FS40T3M1100	55-1100	411,57
40	FS40T3M1700	100-1700	411,57
50	FS50T3M1000	50-1000	483,48
50	FS50T3M1500	100-1500	483,48
50	FS50T3M1600	120-1600	483,48
63	FS63T3M1700	60-1700	646,84
63	FS63T3M2500	90-2500	646,84
63	FS63T3M4000	200-4000	646,84
75	FS75T3M6000	670-6000	1.127,02
75	FS75T3M7500	500-7500	1.127,02
75	FS75T3M0022	4400-22000	1.127,02

Flujómetro largo para **Hidróxido de sodio (NaOH) 30%..**

Densidad: 1,33 kg/l - 20° C. Cuerpo **PVC Transparente**. Juntas: **EPDM**.

FSIV
 encolar.



FLOTADOR INOX AISI 316 CON IMÁN INTERIOR incorporado para contacto exterior (suministrado aparte) ▲

Diámetro Encolar	Ref. Encolar	Escala l/h.	€
25	FS25T3X0125M	6-125	388,76
25	FS25T3X0240M	10-240	388,76
25	FS25T3X0425M	25-425	388,76
25	FS25T3X0725M	35-725	388,76
32	FS32T3X0240M	10-240	418,13
32	FS32T3X0420M	20-420	418,13
32	FS32T3X0700M	25-700	418,13
32	FS32T3X1200M	50-1200	418,13
40	FS40T3X1150M	50-1150	535,76
40	FS40T3X1900M	100-1900	535,76
40	FS40T3X3200M	200-3200	535,76
50	FS50T3X1700M	100-1700	617,45
50	FS50T3X3000M	200-3000	617,45
50	FS50T3X3700M	200-3700	617,45
63	FS63T3X3000M	100-3000	800,38
63	FS63T3X4700M	250-4700	800,38
63	FS63T3X8500M	500-8500	800,38
75	FS75T3X0012M	1000-12000	1.453,71
75	FS75T3X0165M	1500-16500	1.453,71
75	FS75T3X0043M	8800-43000	1.453,71

FLOTADOR PP ROJO CON IMÁN INTERIOR incorporado para contacto exterior (suministrado aparte)

25	FS25T3M0054M	2,5-54	388,76
25	FS25T3M0115M	6-115	388,76
25	FS25T3M0235M	11-235	388,76
25	FS25T3M0410M	28-410	388,76
32	FS32T3M0125M	6-125	418,13
32	FS32T3M0100M	10-100	418,13
32	FS32T3M0395M	11-395	418,13
32	FS32T3M0650M	25-650	418,13
40	FS40T3M0600M	25-600	535,76
40	FS40T3M1100M	55-1100	535,76
40	FS40T3M1700M	100-1700	535,76
50	FS50T3M1000M	50-1000	617,45
50	FS50T3M1500M	100-1500	617,45
50	FS50T3M1600M	120-1600	617,45
63	FS63T3M1700M	60-1700	800,38
63	FS63T3M2500M	90-2500	800,38
63	FS63T3M4000M	200-4000	800,38
75	FS75T3M6000M	670-6000	1.453,71
75	FS75T3M7500M	500-7500	1.453,71
75	FS75T3M0022M	4400-22000	1.453,71

Flujómetro largo para **Hidróxido de sodio (NaOH) 30%..**

Densidad: 1,33 kg/l - 20° C. Cuerpo **PVC Transparente**. Juntas: **EPDM**.

FSIV
 encolar.

FLOTADOR INOX AISI 316

Diámetro Encolar	Ref. Encolar	Escala l/h.	€
25	FS25P3X0125	6-125	349,53
25	FS25P3X0240	10-240	349,53
25	FS25P3X0425	25-425	349,53
25	FS25P3X0725	35-725	349,53
32	FS32P3X0240	10-240	401,79
32	FS32P3X0420	20-420	401,79
32	FS32P3X0700	25-700	401,79
32	FS32P3X1200	50-1200	401,79
40	FS40P3X1150	50-1150	519,48
40	FS40P3X1900	100-1900	519,48
40	FS40P3X3200	200-3200	519,48
50	FS50P3X1700	100-1700	637,02
50	FS50P3X3000	200-3000	637,02
50	FS50P3X3700	200-3700	637,02
63	FS63P3X3000	100-3000	852,60
63	FS63P3X4700	250-4700	852,60
63	FS63P3X8500	500-8500	852,60
75	FS75P3X0012	1000-12000	1.483,13
75	FS75P3X0165	1500-16500	1.483,13
75	FS75P3X0043	8800-43000	1.483,13

FLOTADOR PP ROJO

25	FS25P3M0054	2,5-54	349,53
25	FS25P3M0115	6-115	349,53
25	FS25P3M0235	11-235	349,53
25	FS25P3M0410	28-410	349,53
32	FS32P3M0125	6-125	401,79
32	FS32P3M0100	10-100	401,79
32	FS32P3M0395	11-395	401,79
32	FS32P3M0650	25-650	401,79
40	FS40P3M0600	25-600	519,48
40	FS40P3M1100	55-1100	519,48
40	FS40P3M1700	100-1700	519,48
50	FS50P3M1000	50-1000	637,02
50	FS50P3M1500	100-1500	637,02
50	FS50P3M1600	120-1600	637,02
63	FS63P3M1700	60-1700	852,60
63	FS63P3M2500	90-2500	852,60
63	FS63P3M4000	200-4000	852,60
75	FS75P3M6000	670-6000	1.483,13
75	FS75P3M7500	500-7500	1.483,13
75	FS75P3M0022	4400-22000	1.483,13

 Flujómetro largo para **Hidróxido de sodio (NaOH) 30%..**

 Densidad: 1,33 kg/l 20° C. Cuerpo: **POLYSULFON**. Juntas: **EPDM**.

FSIV
 encolar.

FLOTADOR INOX AISI 316 CON IMÁN INTERIOR incorporado para contacto exterior (suministrado aparte)

Diámetro Encolar	Ref. Encolar	Escala l/h.	€
25	FS25P3X0125M	6-125	470,44
25	FS25P3X0240M	10-240	470,44
25	FS25P3X0425M	25-425	470,44
25	FS25P3X0725M	35-725	470,44
32	FS32P3X0240M	10-240	516,12
32	FS32P3X0420M	20-420	516,12
32	FS32P3X0700M	25-700	516,12
32	FS32P3X1200M	50-1200	516,12
40	FS40P3X1150M	50-1150	643,51
40	FS40P3X1900M	100-1900	643,51
40	FS40P3X3200M	200-3200	643,51
50	FS50P3X1700M	100-1700	770,97
50	FS50P3X3000M	200-3000	770,97
50	FS50P3X3700M	200-3700	770,97
63	FS63P3X3000M	100-3000	1.006,19
63	FS63P3X4700M	250-4700	1.006,19
63	FS63P3X8500M	500-8500	1.006,19
75	FS75P3X0012M	1000-12000	1.809,83
75	FS75P3X0165M	1500-16500	1.809,83
75	FS75P3X0043M	8800-43000	1.809,83

FLOTADOR PP ROJO CON IMÁN INTERIOR incorporado para contacto exterior (suministrado aparte)

25	FS25P3M0054M	2,5-54	470,44
25	FS25P3M0115M	6-115	470,44
25	FS25P3M0235M	11-235	470,44
25	FS25P3M0410M	28-410	470,44
32	FS32P3M0125M	6-125	516,12
32	FS32P3M0100M	10-100	516,12
32	FS32P3M0395M	11-395	516,12
32	FS32P3M0650M	25-650	516,12
40	FS40P3M0600M	25-600	643,51
40	FS40P3M1100M	55-1100	643,51
40	FS40P3M1700M	100-1700	643,51
50	FS50P3M1000M	50-1000	770,97
50	FS50P3M1500M	100-1500	770,97
50	FS50P3M1600M	120-1600	770,97
63	FS63P3M1700M	60-1700	1.006,19
63	FS63P3M2500M	90-2500	1.006,19
63	FS63P3M4000M	200-4000	1.006,19
75	FS75P3M6000M	670-6000	1.809,83
75	FS75P3M7500M	500-7500	1.809,83
75	FS75P3M0022M	4400-22000	1.809,83

 Flujómetro largo para **Hidróxido de sodio (NaOH) 30%..**

 Densidad: 1,33 kg/l 20° C. Cuerpo: **POLYSULFON**. Juntas: **EPDM**.

FSIV
 encolar.

FLOTADOR INOX AISI 316

Diámetro Encolar	Ref. Encolar	Escala l/h.	€
25	FS25T5X0027	1-27	267,82
25	FS25T5X0070	2,5-70	267,82
25	FS25T5X0170	5-170	267,82
25	FS25T5X0350	15-350	267,82
32	FS32T5X0065	2,5-65	303,83
32	FS32T5X0145	5-145	303,83
32	FS32T5X0330	10-330	303,83
32	FS32T5X0675	25-675	303,83
40	FS40T5X0550	25-550	411,57
40	FS40T5X1100	50-1100	411,57
40	FS40T5X2000	100-2000	411,57
50	FS50T5X1000	50-1000	483,48
50	FS50T5X1900	50-1900	483,48
50	FS50T5X2500	100-2500	483,48
63	FS63T5X1800	50-1800	646,84
63	FS63T5X3100	100-3100	646,84
63	FS63T5X6000	250-6000	646,84
75	FS75T5X9000	250-9000	1.127,02
75	FS75T5X0125	500-12500	1.127,02
75	FS75T5X0040	8200-40000	1.127,02

FLOTADOR PP ROJO

25	FS25T5M0095	0,5-9,5	267,82
25	FS25T5M0023	1,5-23	267,82
25	FS25T5M0065	3-65	267,82
25	FS25T5M0145	7-145	267,82
32	FS32T5M0020	1-20	303,83
32	FS32T5M0050	2,5-50	303,83
32	FS32T5M0130	5,5-130	303,83
32	FS32T5M0260	10-260	303,83
40	FS40T5M0200	10-200	411,57
40	FS40T5M0500	20-500	411,57
40	FS40T5M0950	25-950	411,57
50	FS50T5M0425	25-425	483,48
50	FS50T5M0800	25-800	483,48
50	FS50T5M0950	40-950	483,48
63	FS63T5M0800	30-800	646,84
63	FS63T5M1400	40-1400	646,84
63	FS63T5M2500	80-2500	646,84
75	FS75T5M3800	330-3800	1.127,02
75	FS75T5M5200	170-5200	1.127,02
75	FS75T5M0020	4100-20000	1.127,02

 Flujómetro largo para **Hidróxido de sodio (NaOH) 50%..**

 Densidad: 1,53 kg/l - 20° C. Cuerpo **PVC Transparente**. Juntas: **EPDM**.

FSIV
 encolar.



FLOTADOR INOX AISI 316 CON IMÁN INTERIOR incorporado para contacto exterior (suministrado aparte) ▲

Diámetro Encolar	Ref. Encolar	Escala l/h.	€
25	FS25T5X0027M	1-27	388,76
25	FS25T5X0070M	2,5-70	388,76
25	FS25T5X0170M	5-170	388,76
25	FS25T5X0350M	15-350	388,76
32	FS32T5X0065M	2,5-65	418,13
32	FS32T5X0145M	5-145	418,13
32	FS32T5X0330M	10-330	418,13
32	FS32T5X0675M	25-675	418,13
40	FS40T5X0550M	25-550	535,76
40	FS40T5X1100M	50-1100	535,76
40	FS40T5X2000M	100-2000	535,76
50	FS50T5X1000M	50-1000	617,45
50	FS50T5X1900M	50-1900	617,45
50	FS50T5X2500M	100-2500	617,45
63	FS63T5X1800M	50-1800	800,38
63	FS63T5X3100M	100-3100	800,38
63	FS63T5X6000M	250-6000	800,38
75	FS75T5X9000M	250-9000	1.453,71
75	FS75T5X0125M	500-12500	1.453,71
75	FS75T5X0040M	8200-40000	1.453,71

FLOTADOR PP ROJO CON IMÁN INTERIOR incorporado para contacto exterior (suministrado aparte)

25	FS25T5M0095M	0,5-9,5	388,76
25	FS25T5M0023M	1,5-23	388,76
25	FS25T5M0065M	3-65	388,76
25	FS25T5M0145M	7-145	388,76
32	FS32T5M0020M	1-20	418,13
32	FS32T5M0050M	2,5-50	418,13
32	FS32T5M0130M	5,5-130	418,13
32	FS32T5M0260M	10-260	418,13
40	FS40T5M0200M	10-200	535,76
40	FS40T5M0500M	20-500	535,76
40	FS40T5M0950M	25-950	535,76
50	FS50T5M0425M	25-425	617,45
50	FS50T5M0800M	25-800	617,45
50	FS50T5M0950M	40-950	617,45
63	FS63T5M0800M	30-800	800,38
63	FS63T5M1400M	40-1400	800,38
63	FS63T5M2500M	80-2500	800,38
75	FS75T5M3800M	330-3800	1.453,71
75	FS75T5M5200M	170-5200	1.453,71
75	FS75T5M0020M	4100-20000	1.453,71

Flujómetro largo para **Hidróxido de sodio (NaOH) 50%..**

Densidad: 1,53 kg/l - 20° C. Cuerpo **PVC Transparente**. Juntas: **EPDM**.

FSIV
 encolar.

FLOTADOR INOX AISI 316

Diámetro Encolar	Ref. Encolar	Escala l/h.	€
25	FS25P5X0027	1-27	349,53
25	FS25P5X0070	2,5-70	349,53
25	FS25P5X0170	5-170	349,53
25	FS25P5X0350	15-350	349,53
32	FS32P5X0065	2,5-65	401,79
32	FS32P5X0145	5-145	401,79
32	FS32P5X0330	10-330	401,79
32	FS32P5X0675	25-675	401,79
40	FS40P5X0550	25-550	519,48
40	FS40P5X1100	50-1100	519,48
40	FS40P5X2000	100-2000	519,48
50	FS50P5X1000	50-1000	637,02
50	FS50P5X1900	50-1900	637,02
50	FS50P5X2500	100-2500	637,02
63	FS63P5X1800	50-1800	852,60
63	FS63P5X3100	100-3100	852,60
63	FS63P5X6000	250-6000	852,60
75	FS75P5X9000	250-9000	1.483,13
75	FS75P5X0125	500-12500	1.483,13
75	FS75P5X0040	8200-40000	1.483,13

FLOTADOR PP ROJO

25	FS25P5M0095	0,5-9,5	349,53
25	FS25P5M0023	1,5-23	349,53
25	FS25P5M0065	3-65	349,53
25	FS25P5M0145	7-145	349,53
32	FS32P5M0020	1-20	401,79
32	FS32P5M0050	2,5-50	401,79
32	FS32P5M0130	5,5-130	401,79
32	FS32P5M0260	10-260	401,79
40	FS40P5M0200	10-200	519,48
40	FS40P5M0500	20-500	519,48
40	FS40P5M0950	25-950	519,48
50	FS50P5M0425	25-425	637,02
50	FS50P5M0800	25-800	637,02
50	FS50P5M0950	40-950	637,02
63	FS63P5M0800	30-800	852,60
63	FS63P5M1400	40-1400	852,60
63	FS63P5M2500	80-2500	852,60
75	FS75P5M3800	330-3800	1.483,13
75	FS75P5M5200	170-5200	1.483,13
75	FS75P5M0020	4100-20000	1.483,13

 Flujómetro largo para **Hidróxido de sodio (NaOH) 50%..**

 Densidad: 1,53 kg/l - 20° C. Cuerpo **POLYSULFON** Juntas: **EPDM**.

FSIV
 encolar.



FLOTADOR INOX AISI 316 CON IMÁN INTERIOR incorporado para contacto exterior (suministrado aparte)

Diámetro Encolar	Ref. Encolar	Escala l/h.	€
25	FS25P5X0027M	1-27	470,44
25	FS25P5X0070M	2,5-70	470,44
25	FS25P5X0170M	5-170	470,44
25	FS25P5X0350M	15-350	470,44
32	FS32P5X0065M	2,5-65	516,12
32	FS32P5X0145M	5-145	516,12
32	FS32P5X0330M	10-330	516,12
32	FS32P5X0675M	25-675	516,12
40	FS40P5X0550M	25-550	643,51
40	FS40P5X1100M	50-1100	643,51
40	FS40P5X2000M	100-2000	643,51
50	FS50P5X1000M	50-1000	770,97
50	FS50P5X1900M	50-1900	770,97
50	FS50P5X2500M	100-2500	770,97
63	FS63P5X1800M	50-1800	1.006,19
63	FS63P5X3100M	100-3100	1.006,19
63	FS63P5X6000M	250-6000	1.006,19
75	FS75P5X9000M	250-9000	1.809,83
75	FS75P5X0125M	500-12500	1.809,83
75	FS75P5X0040M	8200-40000	1.809,83

FLOTADOR PP ROJO CON IMÁN INTERIOR incorporado para contacto exterior (suministrado aparte)

25	FS25P5M0095M	0,5-9,5	470,44
25	FS25P5M0023M	1,5-23	470,44
25	FS25P5M0065M	3-65	470,44
25	FS25P5M0145M	7-145	470,44
32	FS32P5M0020M	1-20	516,12
32	FS32P5M0050M	2,5-50	516,12
32	FS32P5M0130M	5,5-130	516,12
32	FS32P5M0260M	10-260	516,12
40	FS40P5M0200M	10-200	643,51
40	FS40P5M0500M	20-500	643,51
40	FS40P5M0950M	25-950	643,51
50	FS50P5M0425M	25-425	770,97
50	FS50P5M0800M	25-800	770,97
50	FS50P5M0950M	40-950	770,97
63	FS63P5M0800M	30-800	1.006,19
63	FS63P5M1400M	40-1400	1.006,19
63	FS63P5M2500M	80-2500	1.006,19
75	FS75P5M3800M	330-3800	1.809,83
75	FS75P5M5200M	170-5200	1.809,83
75	FS75P5M0020M	4100-20000	1.809,83

Flujómetro largo para **Hidróxido de sodio (NaOH) 50%..**

Densidad: 1,53 kg/l - 20° C. Cuerpo **POLYSULFON** Juntas: **EPDM**.

FSIV
 encolar.

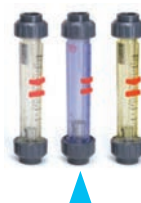

FLOTADOR PP ROJO

Diámetro Encolar	Ref. Encolar	Escala l/h.	€
25	FS25T2M0140	14-140	267,82
25	FS25T2M0230	23-230	267,82
25	FS25T2M0420	42-420	267,82
25	FS25T2M0650	65-650	267,82
32	FS32T2M0230	23-230	303,83
32	FS32T2M0370	37-370	303,83
32	FS32T2M0600	60-600	303,83
32	FS32T2M0900	90-900	303,83
40	FS40T2M0900	90-900	411,57
40	FS40T2M1500	150-1500	411,57
40	FS40T2M2300	200-2300	411,57
50	FS50T2M1500	140-1500	483,48
50	FS50T2M2000	190-2000	483,48
50	FS50T2M2300	230-2300	483,48
63	FS63T2M2300	230-2300	646,84
63	FS63T2M3200	330-3200	646,84
63	FS63T2M4600	470-4600	646,84
75	FS75T2M7500	950-7500	1.127,02
75	FS75T2M9300	930-9300	1.127,02
75	FS75T2M0023	4700-23000	1.127,02

FLOTADOR PP ROJO CON IMÁN INTERIOR incorporado para contacto exterior (suministrado aparte)

25	FS25T2M0140M	14-140	388,76
25	FS25T2M0230M	23-230	388,76
25	FS25T2M0420M	42-420	388,76
25	FS25T2M0650M	65-650	388,76
32	FS32T2M0230M	23-230	418,13
32	FS32T2M0370M	37-370	418,13
32	FS32T2M0600M	60-600	418,13
32	FS32T2M0900M	90-900	418,13
40	FS40T2M0900M	90-900	535,76
40	FS40T2M1500M	150-1500	535,76
40	FS40T2M2300M	200-2300	535,76
50	FS50T2M1500M	140-1500	617,45
50	FS50T2M2000M	190-2000	617,45
50	FS50T2M2300M	230-2300	617,45
63	FS63T2M2300M	230-2300	800,38
63	FS63T2M3200M	330-3200	800,38
63	FS63T2M4600M	470-4600	800,38
75	FS75T2M7500M	950-7500	1.453,71
75	FS75T2M9300M	930-9300	1.453,71
75	FS75T2M0023M	4700-23000	1.453,71

Flujómetro largo para **Ácido clorhídrico (HCl) 30-33%**.

Densidad: 1,16 kg/l - 20° C. Cuerpo **PVC Transparente**. Juntas: **EPDM**.

FSIV
 encolar.

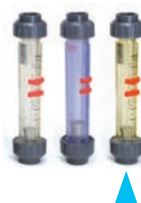

FLOTADOR PP ROJO

Diámetro Encolar	Ref. Encolar	Escala l/h.	€
25	FS25P2M0140	14-140	349,53
25	FS25P2M0230	23-230	349,53
25	FS25P2M0420	42-420	349,53
25	FS25P2M0650	65-650	349,53
32	FS32P2M0230	23-230	401,79
32	FS32P2M0370	37-370	401,79
32	FS32P2M0600	60-600	401,79
32	FS32P2M0900	90-900	401,79
40	FS40P2M0900	90-900	519,48
40	FS40P2M1500	150-1500	519,48
40	FS40P2M2300	200-2300	519,48
50	FS50P2M1500	140-1500	637,02
50	FS50P2M2000	190-2000	637,02
50	FS50P2M2300	230-2300	637,02
63	FS63P2M2300	230-2300	852,60
63	FS63P2M3200	330-3200	852,60
63	FS63P2M4600	470-4600	852,60
75	FS75P2M7500	950-7500	1.483,13
75	FS75P2M9300	930-9300	1.483,13
75	FS75P2M0023	4700-23000	1.483,13

FLOTADOR PP ROJO CON IMÁN INTERIOR incorporado para contacto exterior (suministrado aparte)

25	FS25P2M0140M	14-140	470,44
25	FS25P2M0230M	23-230	470,44
25	FS25P2M0420M	42-420	470,44
25	FS25P2M0650M	65-650	470,44
32	FS32P2M0230M	23-230	516,12
32	FS32P2M0370M	37-370	516,12
32	FS32P2M0600M	60-600	516,12
32	FS32P2M0900M	90-900	516,12
40	FS40P2M0900M	90-900	643,51
40	FS40P2M1500M	150-1500	643,51
40	FS40P2M2300M	200-2300	643,51
50	FS50P2M1500M	140-1500	770,97
50	FS50P2M2000M	190-2000	770,97
50	FS50P2M2300M	230-2300	770,97
63	FS63P2M2300M	230-2300	1.006,19
63	FS63P2M3200M	330-3200	1.006,19
63	FS63P2M4600M	470-4600	1.006,19
75	FS75P2M7500M	950-7500	1.809,83
75	FS75P2M9300M	930-9300	1.809,83
75	FS75P2M0023M	4700-23000	1.809,83

Flujómetro largo para **Ácido clorhídrico (HCl) 30-33%**.

Densidad: 1,16 kg/l - 20° C. Cuerpo **POLYSULFON** Juntas: **EPDM**.

FSIV
 encolar.



FLOTADOR PP ROJO

Diámetro Encolar	Ref. Encolar	Escala Nm³/h	€
25	FS25D0M0025	0,2-2,5	294,00
25	FS25D0M0004	0,3-4	294,00
25	FS25D0M0065	0,5-6,5	294,00
25	FS25D0M0010	1-10	294,00
32	FS32D0M0004	0,4-4	329,91
32	FS32D0M0065	0,5-6,5	329,91
32	FS32D0M0010	1-10	329,91
32	FS32D0M0016	1,5-16	329,91
40	FS40D0M0016	1,5-16	441,00
40	FS40D0M0025	2-25	441,00
40	FS40D0M0040	4-40	441,00
50	FS50D0M0025	2-25	512,89
50	FS50D0M0040	4-40	512,89
50	FS50D0M0050	5-50	512,89
63	FS63D0M0040	4-40	669,62
63	FS63D0M0064	6-64	669,62
63	FS63D0M0100	10-100	669,62
75	FS75D0M0140	15-140	1.146,63
75	FS75D0M0200	20-200	1.146,63

FLOTADOR PP ROJO CON IMÁN INTERIOR incorporado para contacto exterior (suministrado aparte)

25	FS25D0M0025M	0,2-2,5	414,87
25	FS25D0M0004M	0,3-4	414,87
25	FS25D0M0065M	0,5-6,5	414,87
25	FS25D0M0010M	1-10	414,87
32	FS32D0M0004M	0,4-4	444,29
32	FS32D0M0065M	0,5-6,5	444,29
32	FS32D0M0010M	1-10	444,29
32	FS32D0M0016M	1,5-16	444,29
40	FS40D0M0016M	1,5-16	565,16
40	FS40D0M0025M	2-25	565,16
40	FS40D0M0040M	4-40	565,16
50	FS50D0M0025M	2-25	583,20
50	FS50D0M0040M	4-40	583,20
50	FS50D0M0050M	5-50	583,20
63	FS63D0M0040M	4-40	823,26
63	FS63D0M0064M	6-64	823,26
63	FS63D0M0100M	10-100	823,26
75	FS75D0M0140M	15-140	1.460,52
75	FS75D0M0200M	20-200	1.460,52

Flujómetro largo para **Aire**.

Densidad: 1,013 bar abs - 20° C. Cuerpo: **TROGAMID**. Juntas: **EPDM**.



Ref.	Descripción	€
MSMIN01	Contacto de MÍNIMA para flujómetros FS *	195,54
MSMAX01	Contacto de MAXIMA para flujómetros FS *	195,54
	Escala especial	Consultar
	Doble escala	Consultar

Contactos exteriores.

Sólo utilizables con flujómetros que incorporen imán exterior.

* Para usar con flotador con imán incorporado.



d	Ref.	Descripción	€
25	QBIC025	Manguito C-PVC	11,89
32	QBIC032	Manguito C-PVC	15,45
40	QBIC040	Manguito C-PVC	18,96
50	QBIC050	Manguito C-PVC	29,75
63	QBIC063	Manguito C-PVC	33,67
25	QBIGM025	Manguito PP-H	4,39
32	QBIGM032	Manguito PP-H	4,70
40	QBIGM040	Manguito PP-H	5,81
50	QBIGM050	Manguito PP-H	6,94
63	QBIGM063	Manguito PP-H	7,40
25	QBIGF025	Manguito PVDF	21,73
32	QBIGF032	Manguito PVDF	24,22
40	QBIGF040	Manguito PVDF	30,90
50	QBIGF050	Manguito PVDF	35,21
63	QBIGF063	Manguito PVDF	48,83

Manguitos.

Para cada flujómetro es necesario pedir 2 manguitos.

d	Ref.	Descripción	€
25	OR4112F	Junta FKM	2,85
32	OR4131F	Junta FKM	8,05
40	OR0150F	Junta FKM	15,87
50	OR4200F	Junta FKM	12,39
63	OR4275F	Junta FKM	19,70
75	OR6325F	Junta FKM	31,61

Juntas.

Para cada flujómetro es necesario pedir 2 juntas.

d	Ref.	Descripción	€
25	EFC114	Tuerca C-PVC	7,92
32	EFC112	Tuerca C-PVC	15,26
40	EFC200	Tuerca C-PVC	17,36
50	EFC214	Tuerca C-PVC	28,45
63	EFC234	Tuerca C-PVC	45,29
25	EFGM114	Tuerca PP-H	8,56
32	EFGM112	Tuerca PP-H	9,93
40	EFGM200	Tuerca PP-H	12,68
50	EFGM214	Tuerca PP-H	19,65
63	EFGM234	Tuerca PP-H	31,66
25	EFGF114	Tuerca PVDF	37,79
32	EFGF112	Tuerca PVDF	46,88
40	EFGF200	Tuerca PVDF	64,44
50	EFGF214	Tuerca PVDF	94,00
63	EFGF234	Tuerca PVDF	146,16

Tuercas.

Para cada flujómetro es necesario pedir 2 tuercas.

Bajo pedido disponemos también de conexiones rosca hembra de 3/8" a 1" en acero inoxidable AISI 316 y en acero al carbono.



M9.02

Ref.	Montaje	Salidas	Voltaje	€
M9.02.P1	En panel	1x(4-20mA), 2x(S.S.R.), 1 relé	12-24 VDC	1.108,44
M9.02.W1	En pared	1x(4-20mA), 2x(S.S.R.), 1 relé	12-24 VDC	1.282,51
M9.02.W2	En pared	1x(4-20mA), 2x(S.S.R.), 1 rele´	110-230 VAC	1.446,93

Monitor y transmisor de caudal.

Para sensores de caudal.



M9.02

Ref.	Longitud sensor	Material sensor	Juntas	Voltaje	€
M9.02.01	L0	C-PVC	EPDM	12-24 VDC	1.871,06
M9.02.02	L0	C-PVC	FKM	12-24 VDC	1.871,06
M9.02.03	L1	PVDF	EPDM	12-24 VDC	1.900,78
M9.02.04	L1	PVDF	FKM	12-24 VDC	1.900,78
M9.02.05	L0	PVDF	EPDM	12-24 VDC	2.069,11
M9.02.06	L0	PVDF	FKM	12-24 VDC	2.069,11
M9.02.07	L1	PVDF	EPDM	12-24 VDC	2.378,56
M9.02.08	L1	PVDF	FKM	12-24 VDC	2.378,56
M9.02.09	L0	INOX 316 L	EPDM	12-24 VDC	2.357,00
M9.02.10	L0	INOX 316 L	FKM	12-24 VDC	2.357,00
M9.02.11	L1	INOX 316 L	EPDM	12-24 VDC	2.409,89
M9.02.12	L1	INOX 316 L	FKM	12-24 VDC	2.409,89

Monitor y transmisor de caudal con sensor de paletas

Montaje directo y compacto. Salidas 1x(4-20mA), 2x(S.S.R.), 1 relé.



M9.00

Ref.	Montaje	Salidas	Voltaje	€
M9.00.P1	En panel	1x(4-20mA), 1x(S.S.R.)	12-24 VDC	997,71
M9.00.W1	En pared	1x(4-20mA), 1x(S.S.R.)	12-24 VDC	1.171,83
M9.00.W2	En pared	1x(4-20mA), 1x(S.S.R.)	110-230 VAC	1.336,25

Monitor y transmisor de caudal **2 HILOS**.

Para sensores de caudal.

Longitud L0 para diámetros de ø 20-110 mm. Longitud L1 para diámetros de 125-450 mm.

El pedido estándar se compone de sensor + pantalla + accesorios de conexión al tubo. Disponemos de instrucciones de funcionamiento de los modelos.



M9.00

Ref.	Longitud sensor	Material sensor	Juntas	Voltaje	€
M9.00.01	L0	C-PVC	EPDM	12-24 VDC	1.748,13
M9.00.02	L0	C-PVC	FKM	12-24 VDC	1.748,13
M9.00.03	L1	PVDF	EPDM	12-24 VDC	1.777,85
M9.00.04	L1	PVDF	FKM	12-24 VDC	1.777,85
M9.00.05	L0	PVDF	EPDM	12-24 VDC	1.946,17
M9.00.06	L0	PVDF	FKM	12-24 VDC	1.946,17
M9.00.07	L1	PVDF	EPDM	12-24 VDC	2.255,65
M9.00.08	L1	PVDF	FKM	12-24 VDC	2.255,65
M9.00.09	L0	INOX 316 L	EPDM	12-24 VDC	2.234,09
M9.00.10	L0	INOX 316 L	FKM	12-24 VDC	2.234,09
M9.00.11	L1	INOX 316 L	EPDM	12-24 VDC	2.286,98
M9.00.12	L1	INOX 316 L	FKM	12-24 VDC	2.286,98

Monitor y transmisor de caudal **2 HILOS**.

con sensor de paletas

Montaje directo y compacto. Salidas 1x(4-20mA), 2x(S.S.R.).

M9.20



Ref.	Montaje	€
M9.20.P1	En panel	1.147,37
M9.20.W1	En pared	1.321,49

Monitor de caudal. **A BATERÍAS.**

Para sensores de caudal.

M9.20



Ref.	Longitud sensor	Material sensor	Juntas	€
M9.20.01	L0	C-PVC	EPDM	1.914,36
M9.20.02	L0	C-PVC	FKM	1.914,36
M9.20.03	L1	PVDF	EPDM	1.944,09
M9.20.04	L1	PVDF	FKM	1.944,09
M9.20.05	L0	PVDF	EPDM	2.112,44
M9.20.06	L0	PVDF	FKM	2.112,44
M9.20.07	L1	PVDF	EPDM	2.421,91
M9.20.08	L1	PVDF	FKM	2.421,91
M9.20.09	L0	INOX 316 L	EPDM	2.400,38
M9.20.10	L0	INOX 316 L	FKM	2.400,38
M9.20.11	L1	INOX 316 L	EPDM	2.453,24
M9.20.12	L1	INOX 316 L	FKM	2.453,24

Monitor de caudal con sensor de paletas **A BATERÍAS.**

Montaje directo y compacto.

M9.50



Ref.	Montaje	Salidas	Voltaje	€
M9.50.P1	En panel	2x(4-20mA), 2x(S.S.R.), 2 relés	12-24 VDC	1.529,53
M9.50.W1	En pared	2x(4-20mA), 2x(S.S.R.), 2 relés	12-24 VDC	1.749,44
M9.50.W2	En pared	2x(4-20mA), 2x(S.S.R.), 2 relés	110-230 VAC	1.959,42

Monitor de control de trasvase. Para sensores de caudal.

M9.03



Ref.	Montaje	Salidas	Voltaje	€
M9.03.P1	En panel	2x(4-20mA), 2x(S.S.R.), 2 relés	12-24 VDC	1.972,33
M9.03.W1	En pared	2x(4-20mA), 2x(S.S.R.), 2 relés	12-24 VDC	2.204,42
M9.03.W2	En pared	2x(4-20mA), 2x(S.S.R.), 2 relés	110-230 VAC	2.423,64

Monitor y transmisor de caudal **DOBLE** Para sensores de caudal.

M9.05



Ref.	Montaje	Salidas	Voltaje	€
M9.05.P1	En panel	2x(4-20mA), 2x(S.S.R.), 2 relés	12-24 VDC	1.475,08
M9.05.W1	En pared	2x(4-20mA), 2x(S.S.R.), 2 relés	12-24 VDC	1.707,14
M9.05.W2	En pared	2x(4-20mA), 2x(S.S.R.), 2 relés	110-230 VAC	1.926,30

Monitor y transmisor de conductividad. Para sensores de conductividad.

Longitud L0 para diámetros de \varnothing 20-110 mm. Longitud L1 para diámetros de 125-450 mm.

El pedido estándar se compone de sensor + pantalla + accesorios de conexión al tubo. Disponemos de instrucciones de funcionamiento de los modelos.

M9.06



Ref.	Montaje	Salidas	Voltaje	€
M9.06.P1	En panel	2x(4-20mA), 2x(S.S.R.), 2 relés	12-24 VDC	1.486,96
M9.06.W1	En pared	2x(4-20mA), 2x(S.S.R.), 2 relés	12-24 VDC	1.719,02
M9.06.W2	En pared	2x(4-20mA), 2x(S.S.R.), 2 relés	110-230 VAC	1.938,17

Monitor y transmisor de pH / ORP.

Para sensores de pH/ORP.

M9.07



Ref.	Montaje	Salidas	Voltaje	€
M9.07.P1	En panel	2x(4-20mA), 2x(S.S.R.), 2 relés	12-24 VDC	1.969,56
M9.07.W1	En pared	2x(4-20mA), 2x(S.S.R.), 2 relés	12-24 VDC	2.201,76
M9.07.W2	En pared	2x(4-20mA), 2x(S.S.R.), 2 relés	110-230 VAC	2.420,95

Monitor y transmisor de doble par metro: **CONDUCTIVIDAD - CAUDAL.**

M9.08



Ref.	Montaje	Salidas	Voltaje	€
M9.08.P1	En panel	2x(4-20mA), 2x(S.S.R.), 2 relés	12-24 VDC	1.981,56
M9.08.W1	En pared	2x(4-20mA), 2x(S.S.R.), 2 relés	12-24 VDC	2.213,61
M9.08.W2	En pared	2x(4-20mA), 2x(S.S.R.), 2 relés	110-230 VAC	2.432,81

Monitor y transmisor de doble par metro: **pH / ORP - CAUDAL.**

M9.10



Ref.	Montaje	Salidas	Voltaje	€
M9.10.P1	En panel	2x(4-20mA), 2x(S.S.R.), 2 relés	12-24 VDC	1.879,34
M9.10.W1	En pared	2x(4-20mA), 2x(S.S.R.), 2 relés	12-24 VDC	2.111,43
M9.10.W2	En pared	2x(4-20mA), 2x(S.S.R.), 2 relés	110-230 VAC	2.330,65

Monitor y transmisor analógico de doble parámetro.

Longitud L0 para diámetros de ø 20-110 mm. Longitud L1 para diámetros de 125-450 mm.

El pedido estándar se compone de sensor + pantalla + accesorios de conexión al tubo. Disponemos de instrucciones de funcionamiento de los modelos.



F3.00.H.XX

Ref.	Longitud sensor	Material sensor	Juntas	Protección	€
F3.00.H.01	L0	C-PVC	EPDM	IP68	521,61
F3.00.H.02	L0	C-PVC	FKM	IP68	521,61
F3.00.H.03	L1	C-PVC	EPDM	IP68	547,62
F3.00.H.04	L1	C-PVC	FKM	IP68	547,62
F3.00.H.05	L0	PVDF	EPDM	IP68	697,96
F3.00.H.06	L0	PVDF	FKM	IP68	697,96
F3.00.H.07	L1	PVDF	EPDM	IP68	905,87
F3.00.H.08	L1	PVDF	FKM	IP68	905,87
F3.00.H.09	L0	INOX 316	EPDM	IP68	976,78
F3.00.H.10	L0	INOX 316	FKM	IP68	976,78
F3.00.H.11	L1	INOX 316	EPDM	IP68	1.025,47
F3.00.H.12	L1	INOX 316	FKM	IP68	1.025,47

Sensor de caudal de paletas version remota

Alimentación 12-24 VDC. **VERSIÓN HALL.**



Ref.	Longitud sensor	Material sensor	Juntas	Protección	€
F3.00.H.13	L0	C-PVC	EPDM	IP65	521,61
F3.00.H.14	L0	C-PVC	FKM	IP65	521,61
F3.00.H.15	L1	C-PVC	EPDM	IP65	547,62
F3.00.H.16	L1	C-PVC	FKM	IP65	547,62
F3.00.H.17	L0	PVDF	EPDM	IP65	697,96
F3.00.H.18	L0	PVDF	FKM	IP65	697,96
F3.00.H.19	L1	PVDF	EPDM	IP65	905,87
F3.00.H.20	L1	PVDF	FKM	IP65	905,87
F3.00.H.21	L0	INOX 316	EPDM	IP65	976,78
F3.00.H.22	L0	INOX 316	FKM	IP65	976,78
F3.00.H.23	L1	INOX 316	EPDM	IP65	1.025,47
F3.00.H.24	L1	INOX 316	FKM	IP65	1.025,47

Marcados en amarillo los modelos estándar

F3.00.C.XX

Ref.	Longitud sensor	Material sensor	Juntas	Protección	€
F3.00.C.01	L0	C-PVC	EPDM	IP68	521,61
F3.00.C.02	L0	C-PVC	FKM	IP68	521,61
F3.00.C.03	L1	C-PVC	EPDM	IP68	547,62
F3.00.C.04	L1	C-PVC	FKM	IP68	547,62
F3.00.C.05	L0	PVDF	EPDM	IP68	697,96
F3.00.C.06	L0	PVDF	FKM	IP68	697,96
F3.00.C.07	L1	PVDF	EPDM	IP68	905,87
F3.00.C.08	L1	PVDF	FKM	IP68	905,87
F3.00.C.09	L0	INOX 316	EPDM	IP68	976,78
F3.00.C.10	L0	INOX 316	FKM	IP68	976,78
F3.00.C.11	L1	INOX 316	EPDM	IP68	1.025,47
F3.00.C.12	L1	INOX 316	FKM	IP68	1.025,47

Sensor de caudal de paletas version remota

Alimentación 3-5 VDC. **VERSIÓN COIL.**



Ref.	Longitud sensor	Material sensor	Juntas	Protección	€
F3.00.C.13	L0	C-PVC	EPDM	IP65	521,61
F3.00.C.14	L0	C-PVC	FKM	IP65	521,61
F3.00.C.15	L1	C-PVC	EPDM	IP65	547,62
F3.00.C.16	L1	C-PVC	FKM	IP65	547,62
F3.00.C.17	L0	PVDF	EPDM	IP65	697,96
F3.00.C.18	L0	PVDF	FKM	IP65	697,96
F3.00.C.19	L1	PVDF	EPDM	IP65	905,87
F3.00.C.20	L1	PVDF	FKM	IP65	905,87
F3.00.C.21	L0	INOX 316	EPDM	IP65	976,78
F3.00.C.22	L0	INOX 316	FKM	IP65	976,78
F3.00.C.23	L1	INOX 316	EPDM	IP65	1.025,47
F3.00.C.24	L1	INOX 316	FKM	IP65	1.025,47

Longitud L0 para diámetros de ø 20-110 mm. Longitud L1 para diámetros de 125-450 mm.

El pedido estándar se compone de sensor + pantalla + accesorios de conexión al tubo. Disponemos de instrucciones de funcionamiento de los modelos.

F3.00.P.XX

Ref.	Longitud sensor	Material sensor	Juntas	Protección	€
F3.00.P.01	L0	C-PVC	EPDM	IP68	547,62
F3.00.P.02	L0	C-PVC	FKM	IP68	547,62
F3.00.P.03	L1	C-PVC	EPDM	IP68	560,61
F3.00.P.04	L1	C-PVC	FKM	IP68	560,61
F3.00.P.05	L0	PVDF	EPDM	IP68	729,51
F3.00.P.06	L0	PVDF	FKM	IP68	729,51
F3.00.P.07	L1	PVDF	EPDM	IP68	924,41
F3.00.P.08	L1	PVDF	FKM	IP68	924,41
F3.00.P.09	L0	INOX 316	EPDM	IP68	989,40
F3.00.P.10	L0	INOX 316	FKM	IP68	989,40
F3.00.P.11	L1	INOX 316	EPDM	IP68	1.039,87
F3.00.P.12	L1	INOX 316	FKM	IP68	1.039,87

Sensor de caudal de paletas version remota

Alimentación 12-24 VDC. [Para conexión directa a PLC.](#)



F3.01.H.XX

Ref.	Longitud sensor	Material sensor	Juntas	Protección	€
F3.00.C.01	L0	C-PVC	EPDM	IP68	521,61
F3.00.C.02	L0	C-PVC	FKM	IP68	521,61
F3.00.C.03	L1	C-PVC	EPDM	IP68	547,62
F3.00.C.04	L1	C-PVC	FKM	IP68	547,62
F3.00.C.05	L0	PVDF	EPDM	IP68	697,96
F3.00.C.06	L0	PVDF	FKM	IP68	697,96
F3.00.C.07	L1	PVDF	EPDM	IP68	905,87
F3.00.C.08	L1	PVDF	FKM	IP68	905,87
F3.00.C.09	L0	INOX 316	EPDM	IP68	976,78
F3.00.C.10	L0	INOX 316	FKM	IP68	976,78
F3.00.C.11	L1	INOX 316	EPDM	IP68	1.025,47
F3.00.C.12	L1	INOX 316	FKM	IP68	1.025,47

Sensor de caudal de paletas version remota versión compacta.

Alimentación 5-24 VDC. [VERSIÓN COIL.](#)



Ref.	Longitud sensor	Material sensor	Juntas	Protección	€
F3.00.P.13	L0	C-PVC	EPDM	IP65	547,62
F3.00.P.14	L0	C-PVC	FKM	IP65	547,62
F3.00.P.15	L1	C-PVC	EPDM	IP65	560,61
F3.00.P.16	L1	C-PVC	FKM	IP65	560,61
F3.00.P.17	L0	PVDF	EPDM	IP65	729,51
F3.00.P.18	L0	PVDF	FKM	IP65	729,51
F3.00.P.19	L1	PVDF	EPDM	IP65	924,41
F3.00.P.20	L1	PVDF	FKM	IP65	924,41
F3.00.P.21	L0	INOX 316	EPDM	IP65	989,40
F3.00.P.22	L0	INOX 316	FKM	IP65	989,40
F3.00.P.23	L1	INOX 316	EPDM	IP65	1.039,87
F3.00.P.24	L1	INOX 316	FKM	IP65	1.039,87

Sensor de caudal de paletas version remota

Alimentación 12-24 VDC. [Para conexión directa a PLC.](#)



F3.01.C.XX

Ref.	Longitud sensor	Material sensor	Juntas	Protección	€
F3.00.C.13	L0	C-PVC	EPDM	IP65	521,61
F3.00.C.14	L0	C-PVC	FKM	IP65	521,61
F3.00.C.15	L1	C-PVC	EPDM	IP65	547,62
F3.00.C.16	L1	C-PVC	FKM	IP65	547,62
F3.00.C.17	L0	PVDF	EPDM	IP65	697,96
F3.00.C.18	L0	PVDF	FKM	IP65	697,96
F3.00.C.19	L1	PVDF	EPDM	IP65	905,87
F3.00.C.20	L1	PVDF	FKM	IP65	905,87
F3.00.C.21	L0	INOX 316	EPDM	IP65	976,78
F3.00.C.22	L0	INOX 316	FKM	IP65	976,78
F3.00.C.23	L1	INOX 316	EPDM	IP65	1.025,47
F3.00.C.24	L1	INOX 316	FKM	IP65	1.025,47

Sensor de caudal de paletas version remota versión compacta.

Alimentación 3-5 VDC. [VERSIÓN COIL.](#)

Longitud L0 para diámetros de ø 20-110 mm. Longitud L1 para diámetros de 125-450 mm.

El pedido estándar se compone de sensor + pantalla + accesorios de conexión al tubo. Disponemos de instrucciones de funcionamiento de los modelos.



F3.20.X.01

Ref.	Longitud sensor	Material sensor	Versión	Protección	€
F3.20.H.01	107	INOX 316	HALL	IP68	818,90
F3.20.P.01	107	INOX 316	Directo a PLC	IP68	859,83

Sensor de caudal de paletas para
ALTAS PRESIONES Y TEMPERATURAS.



F3.10.H.XX

Ref.	Longitud sensor	Material sensor	Juntas	Protección	€
F3.10.H.01	41	ABS	EPDM	IP65	215,29
F3.10.H.02	41	ABS	FKM	IP65	215,38

Minisensor de caudal de paletas
 Alimentación 5-24 VDC. **VERSIÓN HALL.**



F6.30

Ref.	Longitud sensor	Material sensor	Juntas	Protección	€
F6.30.01	L0	C-PVC	EPDM	IP65	1.372,08
F6.30.02	L0	C-PVC	FKM	IP65	1.372,08
F6.30.03	L1	C-PVC	EPDM	IP65	1.403,80
F6.30.04	L1	C-PVC	FKM	IP65	1.403,80
F6.30.05	L0	PVDF	EPDM	IP65	1.583,59
F6.30.06	L0	PVDF	FKM	IP65	1.583,59
F6.30.07	L1	PVDF	EPDM	IP65	1.914,03
F6.30.08	L1	PVDF	FKM	IP65	1.914,03
F6.30.09	L0	INOX 316	EPDM	IP65	1.924,64
F6.30.10	L0	INOX 316	FKM	IP65	1.924,64
F6.30.11	L1	INOX 316	EPDM	IP65	1.982,77
F6.30.12	L1	INOX 316	FKM	IP65	1.982,77

Transmisor de caudal de paletas **CON SALIDA 4-20 mA.**

Alimentación 5-24 VDC. **VERSIÓN COIL.**

Rango caudal: 0,15 - 8 m/s.



F3.05.XX

Ref.	Longitud sensor	Material sensor	Juntas	Protección	€
F3.05.01	L0	C-PVC	EPDM	IP65	468,58
F3.05.02	L0	C-PVC	FKM	IP65	468,58
F3.05.03	L1	PVDF	EPDM	IP65	497,42
F3.05.04	L1	PVDF	FKM	IP65	497,42
F3.05.05	L0	PVDF	EPDM	IP65	731,73
F3.05.06	L0	PVDF	FKM	IP65	731,73
F3.05.07	L1	PVDF	EPDM	IP65	776,76
F3.05.08	L1	PVDF	FKM	IP65	776,76
F3.05.09	L0	INOX 316	EPDM	IP65	888,51
F3.05.10	L0	INOX 316	FKM	IP65	888,51
F3.05.11	L1	INOX 316	EPDM	IP65	933,59
F3.05.12	L1	INOX 316	FKM	IP65	933,59

Sensor de caudal de paletas

INTERRUPTOR DE CAUDAL. BATCH CONTROLER.

Transmite una se al de apertura al detectar ausencia de caudal.

Longitud L0 para diámetros de ø 20-110 mm. Longitud L1 para diámetros de 125-450 mm.

El pedido estándar se compone de sensor + pantalla + accesorios de conexión al tubo. Disponemos de instrucciones de funcionamiento de los modelos.



F6.60

Ref.	Longitud sensor	Material sensor	Juntas	Protección	€
F6.60.09	L0	INOX 316L/PVDF	EPDM	IP65	2.182,98
F6.60.10	L0	INOX 316L/PVDF	FKM	IP65	2.182,98
F6.60.11	L1	INOX 316L/PVDF	EPDM	IP65	2.241,37
F6.60.12	L1	INOX 316L/PVDF	FKM	IP65	2.241,37
F6.60.33	L0	CuNI/PVDF	EPDM	IP65	2.387,40
F6.60.34	L0	CuNI/PVDF	FKM	IP65	2.387,40
F6.60.35	L1	CuNI/PVDF	EPDM	IP65	2.445,77
F6.60.36	L1	CuNI/PVDF	FKM	IP65	2.445,77
F6.60.38	L0	INOX 316/PEEK	FKM	IP65	2.387,40
F6.60.40	L1	INOX 316/PEEK	FKM	IP65	2.445,77

Sensor de caudal electromagnético **BIDIRECCIONAL**.
Alimentación 12-24 VDC. **VERSIÓN CIEGA**. Rango caudal: 0,15 - 8 m/s.



F6.63

Ref.	Longitud sensor	Material sensor	Juntas	Protección	€
F6.63.09	L0	INOX 316L/PVDF	EPDM	IP65	1.855,75
F6.63.10	L0	INOX 316L/PVDF	FKM	IP65	1.855,75
F6.63.11	L1	INOX 316L/PVDF	EPDM	IP65	1.905,38
F6.63.12	L1	INOX 316L/PVDF	FKM	IP65	1.905,38
F6.63.33	L0	CuNI/PVDF	EPDM	IP65	2.029,51
F6.63.34	L0	CuNI/PVDF	FKM	IP65	2.029,51
F6.63.35	L1	CuNI/PVDF	EPDM	IP65	2.079,16
F6.63.36	L1	CuNI/PVDF	FKM	IP65	2.079,16
F6.63.38	L0	INOX 316/PEEK	EPDM	IP65	2.029,51
F6.63.40	L1	INOX 316/PEEK	FKM	IP65	2.079,16

Sensor de caudal electromagnético **MONODIRECCIONAL**.
Alimentación 12-24 VDC. **VERSIÓN CIEGA**. Rango caudal: 0,15 - 8 m/s.



F6.61.01

Ref.	Material cuerpo	Protección	Longitud mm..	€
F6.61.01	INOX 304/PVDF/INOX 316L	EPDM	IP65	4.703,79

Sensor de caudal electromagnético para tomas en carga.
Alimentación 12-24 VDC. **VERSIÓN HOT TAP**.
Rango caudal: 0,15 - 8 m/s.



F3.8X.H.OX

Ref.	Caudal	Material	Engranajes	Juntas	€
F3.81.H.01	10-100 l/h	PP	ECTFE	FKM	974,18
F3.81.H.02	10-100 l/h	ECTFE	ECTFE	FKM	1.433,45
F3.81.H.03	10-100 l/h	INOX 316 L	ECTFE	FKM	1.827,08
F3.82.H.01	25-150 l/h	PP	ECTFE	FKM	974,18
F3.82.H.02	25-150 l/h	ECTFE	ECTFE	FKM	1.433,45
F3.82.H.03	25-150 l/h	INOX 316 L	ECTFE	FKM	1.827,08

Sensor oval para caudales bajos. Versión especial con salida
Alimentación 12-24 VDC. Protección n IP65. 4-20mA bajo pedido



ULF01.X.X

R

Ref.	Voltaje	Versión	Material	€
ULF01.H.0	5-24 VDC	HALL	POM-FKM	334,61
ULF01.H.2	5-24 VDC	HALL	ECTFE-FKM	826,59
ULF01.H.3	5-24 VDC	HALL	ECTFE-KALREZ	1.292,41
ULF01.R.0	-	REED	POM-FKM	364,09
ULF01.R.2	-	REED	ECTFE-FKM	777,41
ULF01.R.3	-	REED	ECTFE-KALREZ	1.216,96

Sensor para caudales bajos entre 1,5-100 l/h. Protección IP65.



ULF03.X.X

R

Ref.	Voltaje	Versión	Material	€
ULF03.H.0	5-24 VDC	HALL	POM-FKM	334,61
ULF03.H.2	5-24 VDC	HALL	ECTFE-FKM	826,59
ULF03.H.3	5-24 VDC	HALL	ECTFE-KALREZ	1.292,41
ULF03.R.0	-	REED	POM-FKM	364,09
ULF03.R.2	-	REED	ECTFE-FKM	777,41
ULF03.R.3	-	REED	ECTFE-KALREZ	1.216,96

Sensor para caudales bajos entre 6-250 l/h. Protección IP65.

Longitud L0 para diámetros de ø 20-110 mm. Longitud L1 para diámetros de 125-450 mm.
El pedido estándar se compone de sensor + pantalla + accesorios de conexión al tubo. Disponemos de instrucciones de funcionamiento de los modelos.



pH200/ORP200



Ref.	Descripción	Cable (venta aparte)	Salidas	Instalación	€
PH200C	Electrodo combinado pH/referencia	No necesario	5 metros cable	EG50P, EG75P, MK150200, MIFV20X05, MIMC20X05	276,26
PH222CD	Electrodo combinado pH/referencia doble toma tipo cartucho	CN653, CN653TC1	Twist-Lock (BNC)	EG50P, EG75P, MIFV20X05, MIMC20X05	341,60
PH223CD	Electrodo combinado pH/referencia doble toma tipo cartucho para accesorios FLS	CN653	Twist-Lock (BNC)	F3.SP2.4	395,04
PH222CDTC	Electrodo combinado pH/referencia doble toma tipo cartucho con Pt 1000	CN653	Twist-Lock (BNC)	F3.SP2.4	879,76
ORP200C	Electrodo combinado ORP/referencia	No necesario	5 metros cable	EG50P, EG75P, MK150200, MIFV20X05, MIMC20X05	371,28
ORP222CD	Electrodo combinado ORP/referencia doble toma tipo cartucho	CN653	Twist-Lock (BNC)	EG50P, EG75P, MIFV20X05, MIMC20X05	536,49
ORP223CD	Electrodo combinado de ORP/referencia doble toma tipo cartucho para accesorios FLS	CN653	Twist-Lock (BNC)	F3.SP2.4	592,68

Electrodo de pH / Electrodo de ORP.

Rango de funcionamiento: 0-14 pH / Rango de funcionamiento: ± 2000 Mv.

Cuerpo epóxico



pH400/ORP400

Ref.	Descripción	Cable (venta aparte)	Salidas	Instalación	€
PH431CD	Electrodo combinado de pH/referencia doble toma	No necesario	S7	GEG135	891,19
PH435CD	Electrodo combinado de pH/referencia doble toma para altas temperaturas	CE5S7	S7	GEG135, EG135SE	1.086,29
ORP431CD	Electrodo combinado de ORP/referencia de doble toma	No necesario	S7	GEG135	995,89

Electrodo de pH / Electrodo de ORP.

Rango de funcionamiento: 0-14 pH / Rango de funcionamiento: ± 1000 Mv.

Cuerpo de cristal.

ORP600/pH600



Ref.	Descripción	Cable (venta aparte)	Conexión	Instalación	€
ORP660CD	Electrodo de superficie plana combinado de ORP con doble toma de C-PVC	CN653	Twist-Lock (BNC)	EG66P, MK660	923,77
ORP650CD	Electrodo de superficie plana combinado de ORP con doble toma de C-PVC	CN653 / CN653 TC1	Twist-Lock (BNC)	MIFV20X05, MIMC20X05	923,77
ORP655CD	Electrodo de superficie plana combinado de ORP con doble toma de C-PVC y gel de relleno presurizado	CN653	Twist-Lock (BNC)	WT675, WT675 TC1	969,81
ORP660CDDA	Electrodo combinado de pH/ORP de superficie plana con interrupción de bucle de tierra. Aplicaciones: presencia de corrientes parásitas	CN653	Twist-Lock (BNC)	EG66P, MK660	1.752,51
ORP650CDDA	Electrodo combinado de pH/ORP de superficie plana con interrupción de bucle de tierra. Aplicaciones: presencia de corrientes parásitas	CN653 / CN653 TC1	Twist-Lock (BNC)	MIFV20X05, MIMC20X05	1.701,06
PH660CD	Electrodo de pH superficie plana combinado doble toma de C-PVC	CN653	Twist-Lock (BNC)	EG66P, MK660	778,20
PH650CD	Electrodo de pH superficie plana combinado doble toma de C-PVC	CN653 / CN653 TC1	Twist-Lock (BNC)	MIFV20X05, MIMC20X05	778,20
PH655CD	Electrodo de pH superficie plana combinado, doble toma de C-PVC y con gel de relleno presurizado	CN653	Twist-Lock (BNC)	WT675, WT675 TC1	816,81
PH660CDHF	Electrodo de pH superficie plana combinado doble toma de C-PVC. Líquidos con HF (máx. 2%)	CN653	Twist-Lock (BNC)	EG66P, MK660	952,01
PH650CDHF	Electrodo de pH superficie plana combinado doble toma de C-PVC. Líquidos con HF (máx. 2%)	CN653 / CN653 TC1	Twist-Lock (BNC)	MIFV20X05, MIMC20X05	1.130,22
PH655CDHF	Electrodo de pH superficie plana combinado, doble toma de C-PVC y con gel de relleno presurizado. Líquidos con HF (máx. 2%)	CN653	Twist-Lock (BNC)	WT675, WT675 TC1	1.130,22
PH660CDDA	Electrodo combinado de pH de superficie plana con interrupción de bucle de tierra. Aplicaciones: presencia de corrientes parásitas	CN653	Twist-Lock (BNC)	EG66P, MK660	1.488,11
PH650CDDA	Electrodo combinado de pH de superficie plana con interrupción de bucle de tierra. Aplicaciones: presencia de corrientes parásitas	CN653 / CN653 TC1	Twist-Lock (BNC)	MIFV20X05, MIMC20X05	1.488,11
PH660CDLC	Electrodo de pH con superficie plana combinado y doble toma de C-PVC. Líquidos con baja conductividad (<100 ms)	CN653	Twist-Lock (BNC)	EG66P, MK660	840,57
PH650CDLC	Electrodo de pH con superficie plana combinado y doble toma de C-PVC. Líquidos con baja conductividad (<100 ms)	CN653 / CN653 TC1	Twist-Lock (BNC)	MIFV20X05, MIMC20X05	990,62
PH655CDLC	Electrodo de pH con superficie plana combinado, doble toma de C-PVC y con gel de relleno presurizado. Líquidos con baja conductividad (<100 ms)	CN653	Twist-Lock (BNC)	WT675, WT675 TC1	990,62

Electrodo de ORP / Electrodo de PH.

De superficie plana.

pH800

Ref.	Descripción	Aplicación / Rango operativo	Conexión	Instalación	€
PH870CDTDC	Electrodo pH Ryton doble unión con Pt1000	0-14 pH (0-12,3 pH sin Na + error)	5 metros	¾" NPT	1.270,11
PH870CDTCHM	Electrodo pH Ryton doble unión con Pt1000	0-14 pH (0-12,3 pH sin Na + error) Montaje horizontal	5 metros	¾" NPT	1.379,96
PH870CDTCLC	Electrodo pH Ryton doble unión con Pt1000	0-14 pH (0-12,3 pH sin Na + error) Baja conductividad (<100 µS)	5 metros	¾" NPT	1.352,48
PH870CDTCHF	Electrodo pH Ryton doble unión con Pt1000	0-14 pH (0-12,3 pH sin Na + error) Presencia de HF (máx 2%)	5 metros	¾" NPT	1.434,91

Electrodo de PH.

De superficie plana.



C150/C200

Ref.	Descripción	Rango funcionamiento	Constante de celda	Conexión	Instalación	€
C150.01TC	Sensor de conductividad en grafito con sensor de temperatura	0,1 μ S a 2.000 μ S	0,1 Cell	5 metros	EG50P, EG75P, MIFV20X05, MIMC20X05	520,82
C150.1TC	Sensor de conductividad en grafito con sensor de temperatura	1 μ S a 20.000 μ S	1,0 Cell	5 metros	EG50P, EG75P, MIFV20X05, MIMC20X05, MK150200	520,82
C200.01TC	Sensor de conductividad en grafito con sensor de temperatura	0,1 μ S a 2.000 μ S	0,1 Cell	5 metros	EG50P, EG75P, MIFV20X05, MIMC20X05	666,17
C200.1TC	Sensor de conductividad en grafito con sensor de temperatura	1 μ S a 20.000 μ S	1,0 Cell	5 metros	EG50P, EG75P, MIFV20X05, MIMC20X05	666,17
C200.10TC	Sensor de conductividad en grafito con sensor de temperatura	10 μ S a 200.000 μ S	10,0 Cell	5 metros	EG50P, EG75P, MIFV20X05, MIMC20X05	666,17

Sensor de conductividad.

De cuerpo epóxico.



C6.30

Ref.	Descripción	Rango funcionamiento	Conexión	Instalación	€
C6.30.01	Transmisor de conductividad inductivo con sensor de temperatura incluido	0-10 mS	3 metros	Rosca macho 1 1/2" NPT	3.487,24
C6.30.02	Transmisor de conductividad inductivo con sensor de temperatura incluido	0-100 mS	3 metros	Rosca macho 1 1/2" NPT	2.212,87
C6.30.03	Transmisor de conductividad inductivo con sensor de temperatura incluido	0-1.000 mS	3 metros	Rosca macho 1 1/2" NPT	2.212,87

Transmisor de conductividad inductivo

Cuerpo en C-PVC.



C100/C300

Ref.	Descripción	Rango funcionamiento	Constante de celda	Conexión	Instalación	€
C100.01TC	Sensor de PP con electrodo de conductividad en acero inox con sensor de temperatura	0,1 μ S a 2.000 μ S	0,1 Cell	Conector 4 clavijas	Rosca macho 3/4" BSP	466,30
C100.02TC	Sensor de PP con electrodo de conductividad en acero inox con sensor de temperatura	0,2 μ S a 4.000 μ S	0,2 Cell	Conector 4 clavijas	Rosca macho 3/4" BSP	466,30
C100.1TC	Sensor de PP con electrodo de conductividad en acero inox con sensor de temperatura	1 μ S a 20.000 μ S	1,0 Cell	Conector 4 clavija	Rosca macho 3/4" BSP	466,30
C300.001TC	Sensor con cuerpo y electrodos de conductividad en acero inox.	0,055 μ S a 200 μ S	0,01 Cell	3 metros	EG12 SS	923,50
C300.001TCCK	Sensor con cuerpo y electrodo de conductividad en acero inox. con certificado de constante de Cell	0,055 μ S a 200 μ S	0,01 Cell	3 metros	EG12 SS	1.176,71
C300.10TC	Sensor con cuerpo y electrodos de conductividad en acero inox.	10 μ S a 200.000 μ S	10,0 Cell	3 metros	EG12 SS	923,50

Sensor de conductividad.

C100 cuerpo en PP y C300 cuerpo en inox.



d x Rh	Ref.	DN	Material	Longitud sensor	Juntas	€
20	TFIV20B	15	PVC-U	L0	EPDM	134,62
25	TFIV25B	20	PVC-U	L0	EPDM	134,62
32	TFIV32B	25	PVC-U	L0	EPDM	169,19
40	TFIV40B	32	PVC-U	L0	EPDM	169,19
50	TFIV50B	40	PVC-U	L0	EPDM	188,44
20	TFIV20D	15	PVC-U	L0	FKM	134,62
25	TFIV25D	20	PVC-U	L0	FKM	134,62
32	TFIV32D	25	PVC-U	L0	FKM	169,19
40	TFIV40D	32	PVC-U	L0	FKM	169,19
50	TFIV50D	40	PVC-U	L0	FKM	188,44
20	TFIM20B	15	PP-H	L0	EPDM	155,77
25	TFIM25B	20	PP-H	L0	EPDM	155,77
32	TFIM32B	25	PP-H	L0	EPDM	199,98
40	TFIM40B	32	PP-H	L0	EPDM	199,98
50	TFIM50B	40	PP-H	L0	EPDM	228,82
20	TFIM20D	15	PP-H	L0	FKM	155,77
25	TFIM25D	20	PP-H	L0	FKM	155,77
32	TFIM32D	25	PP-H	L0	FKM	199,98
40	TFIM40D	32	PP-H	L0	FKM	199,98
50	TFIM50D	40	PP-H	L0	FKM	228,82

Te

Otras conexiones disponibles bajo pedido



Ref.	Material	Juntas	€
HF6.004	0-400 mbarg	PVDF, PUR, FKM cerámica	1.757,76
HF6.010	0-1.000 mbarg	PVDF, PUR, FKM cerámica	1.757,76
HF6.100	0-10 barg	PVDF, PUR, FKM cerámica	1.757,76
HF6.160	0-16 barg	PVDF, PUR, FKM cerámica	1.757,76

Transmisor de presión y nivel de profundidad..

d x Rh	Ref.	DN	Material	Longitud sensor	Juntas	€
20	TFIF20B	15	PVDF	L0	EPDM	251,90
25	TFIF25B	20	PVDF	L0	EPDM	251,90
32	TFIF32B	25	PVDF	L0	EPDM	269,24
40	TFIF40B	32	PVDF	L0	EPDM	269,24
50	TFIF50B	40	PVDF	L0	EPDM	303,83
20	TFIF20D	15	PVDF	L0	FKM	251,90
25	TFIF25D	20	PVDF	L0	FKM	251,90
32	TFIF32D	25	PVDF	L0	FKM	269,24
40	TFIF40D	32	PVDF	L0	FKM	269,24
50	TFIF50D	40	PVDF	L0	FKM	303,83
20	TFIV20BE	15	PVC-U+PE	L0	EPDM	134,62
25	TFIV25BE	20	PVC-U+PE	L0	EPDM	134,62
32	TFIV32BE	25	PVC-U+PE	L0	EPDM	169,19
40	TFIV40BE	32	PVC-U+PE	L0	EPDM	169,19
50	TFIV50BE	40	PVC-U+PE	L0	EPDM	188,44
20	TFIV20DE	15	PVC-U+PE	L0	FKM	134,62
25	TFIV25DE	20	PVC-U+PE	L0	FKM	134,62
32	TFIV32DE	25	PVC-U+PE	L0	FKM	169,19
40	TFIV40DE	32	PVC-U+PE	L0	FKM	169,19
50	TFIV50DE	40	PVC-U+PE	L0	FKM	188,44
½"	TFFX20	15	INOX316	L0		388,43
¾"	TFFX25	20	INOX316	L0		388,43
1"	TFFX32	25	INOX316	L0		388,43
1¼"	TFFX40	32	INOX316	L0		421,13



INDUSTRIA

Medición Accesorios de instalación



d	Ref.	DN	Material	Longitud sensor	€
50-225	WAIXLO	40-200	Inox 316L	L0	207,70
250-600	WAIXL1	225-600	Inox 316L	L1	234,57

Inserto para tubos metálicos.



Ref.	Cuerpo	DN	€
WAIXHT	Inox 316L	350-400	207,70

Adaptador para toma en carga [para sensores](#).



d	Ref.	DN	Cuerpo	Longitud sensor	Juntas	€
63	SVIC063BVC	50	PVC-U	L0	EPDM	152,28
75	SVIC075BVC	65	PVC-U	L0	EPDM	200,76
90	SVIC090BVC	80	PVC-U	L0	EPDM	200,76
110	SVIC110BVC	100	PVC-U	L0	EPDM	218,05
125	SVIC125BVC	110	PVC-U	L1	EPDM	231,91
140	SVIC140BVC	125	PVC-U	L1	EPDM	242,29
160	SVIC160BVC	150	PVC-U	L1	EPDM	302,87
200	SVIC200BVC	180	PVC-U	L1	EPDM	302,87
225	SVIC225BVC	200	PVC-U	L1	EPDM	314,96
63	SVIC063DVC	50	PVC-U	L0	FKM	315,09
75	SVIC075DVC	65	PVC-U	L0	FKM	315,09
90	SVIC090DVC	80	PVC-U	L0	FKM	315,09
110	SVIC110DVC	100	PVC-U	L0	FKM	218,05
250	SMIC250IVC	225	PP	L0	NBR	392,29
280	SMIC280IVC	250	PP	L1	NBR	438,40
315	SMIC315IVC	300	PP	L1	NBR	438,40

Collarín [para tubos de PVC-U y C-PVC](#).

Inserto en C-PVC.



Ref.	Descripción	€
WAIXHP	Kit inserto adaptación Inox 316 para F3.20.X.01	489,16

Accesorio de instalación.

[para sensor F3.20.X.01](#).

De Ø 50 a Ø 225 (DN40 A DN200).

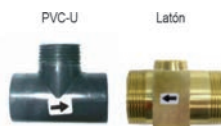

d	Ref.	DN	Cuerpo	Conexion	€
20	TMIV20MF	15	PVC-U	H encolar	73,08
25	TMIV25MF	20	PVC-U	H encolar	76,89
32	TMIV32MF	25	PVC-U	H encolar	76,89
40	TMIV40MF	32	PVC-U	H encolar	80,77
50	TMIV50MF	40	PVC-U	H encolar	80,77
1¼"	TMFODN23	23	Latón	M roscar	313,46

Te. [para minisensor F3.10.H.XX](#).



d	Ref.	DN	Cuerpo	Longitud sensor	Juntas	€
63	SVIC063BME	50	PVC-U	L0	EPDM	152,28
75	SVIC075BME	65	PVC-U	L0	EPDM	200,76
90	SVIC090BME	80	PVC-U	L0	EPDM	200,76
110	SVIC110BME	100	PVC-U	L0	EPDM	218,05
125	SVIC125BME	110	PVC-U	L1	EPDM	231,91
140	SVIC140BME	125	PVC-U	L1	EPDM	242,29
160	SVIC160BME	150	PVC-U	L1	EPDM	302,87
200	SVIC200BME	180	PVC-U	L1	EPDM	302,87
225	SVIC225BME	200	PVC-U	L1	EPDM	314,96
63	SVIC063DME	50	PVC-U	L0	FKM	218,12
75	SVIC075DME	65	PVC-U	L0	FKM	218,12
90	SVIC090DME	80	PVC-U	L0	FKM	218,12
110	SVIC110DME	100	PVC-U	L0	FKM	218,05
250	SMIC250IME	225	PP	L0	NBR	392,29
280	SMIC280IME	250	PP	L1	NBR	438,40
315	SMIC315IME	300	PP	L1	NBR	438,40

Collarín [para tubos de PP-H y PE](#).

Inserto en C-PVC.



d	Ref.	DN	Cuerpo	Longitud sensor	Juntas	€
63	SVIF063BF	50	PVC-U	L0	EPDM	197,31
75	SVIF075BF	65	PVC-U	L0	EPDM	261,31
90	SVIF090BF	80	PVC-U	L0	EPDM	261,31
110	SVIF110BF	100	PVC-U	L0	EPDM	283,83

Collarín **para tubos de PVDF**

Inserto en PVDF.



Ref.	DN	Cuerpo	Longitud sensor	Tolerancia	€
SZIC080I	80	Acero+inox	L0	88-104	248,09
SZIC100I	100	Acero+inox	L0	112-126	255,75
SZIC125I	125	Acero+inox	L0	140-154	326,89
SZIC150I	150	Acero+inox	L0	168-184	346,10
SZIC200I	200	Acero+inox	L1	218-244	361,53
SZIC250I	250	Acero+inox	L1	272-295	382,63
SZIC300I	300	Acero+inox	L1	322-354	405,73
SZIC350I	350	Acero+inox	L1	356-414	440,34
SZIC400I	400	Acero+inox	L1	406-472	499,96
SZIC450I	450	Acero+inox	L1	457-534	607,65

Collarín metálico.

Junta en NBR. Inserto en C-PVC.



d	Ref.	DN	Cuerpo	Longitud sensor	Juntas	€
63	SVIF063DF	50	PVC-U	L0	FKM	197,31
75	SVIF075DF	65	PVC-U	L0	FKM	261,31
90	SVIF090DF	80	PVC-U	L0	FKM	261,31
110	SVIF110DF	100	PVC-U	L0	FKM	283,83

Collarín **para tubos de PVDF**

Inserto en PVDF.



Ref.	DN	Cuerpo	Longitud sensor	Tolerancia	€
SZIC080IHT	80	Acero+inox	L0	88-104	248,09
SZIC100IHT	100	Acero+inox	L0	112-126	255,75
SZIC125IHT	125	Acero+inox	L0	140-154	326,89
SZIC150IHT	150	Acero+inox	L0	168-184	346,10
SZIC200IHT	200	Acero+inox	L1	218-244	361,53
SZIC250IHT	250	Acero+inox	L1	272-295	382,63
SZIC300IHT	300	Acero+inox	L1	322-354	405,73
SZIC350IHT	350	Acero+inox	L1	356-414	440,34
SZIC400IHT	400	Acero+inox	L1	406-472	499,96
SZIC450IHT	450	Acero+inox	L1	457-534	607,65

Collarín metálico. **con toma en carga.**



Salida 2" rosca hembra. Junta en NBR.

Longitud L0 para diámetros de ø 20-110 mm. Longitud L1 para diámetros de 125-450 mm.



Adaptadores para instalación en línea, sumergibles e instalación Wet-Tap.

	Ref.	Cuerpo	Descripción	Para electrodos	€
	EG12SS	Inox	Prensaestopas de electrodos macho ½"	C300	238,38
	TCONIV32E	PVC-U	Accesorio en T ø 32 DN25	C150-200	138,50
	TCONIV40E	PVC-U	Accesorio en T ø 40 DN32	C150-200	145,43
	TCONIV50E	PVC-U	Accesorio en T ø 50 DN40	C150-200	152,71
	TCONIC32E	C-PVC	Accesorio en T ø 32 DN25	C150-200	153,76
	TCONIC40E	C-PVC	Accesorio en T ø 40 DN32	C150-200	161,47
	TCONIC50E	C-PVC	Accesorio en T ø 50 DN40	C150-200	169,52
	TPHIV32E	PVC-U	Accesorio en T ø 32 DN25	PH/ORP200 (NO p/PH223CD,ORP223CD)	138,47
	TPHIV40E	PVC-U	Accesorio en T ø 40 DN32	PH/ORP200 (NO p/PH223CD,ORP223CD)	108,77
	TPHIV50E	PVC-U	Accesorio en T ø 50 DN40	PH/ORP200 (NO p/PH223CD,ORP223CD)	152,68
	TPHIC32E	C-PVC	Accesorio en T ø 32 DN25	PH/ORP200 (NO p/PH223CD,ORP223CD)	123,00
	TPHIC40E	C-PVC	Accesorio en T ø 40 DN32	PH/ORP200 (NO p/PH223CD,ORP223CD)	129,18
	TPHIC50E	C-PVC	Accesorio en T ø 50 DN40	PH/ORP200 (NO p/PH223CD,ORP223CD)	135,60
	TPHIC32C	C-PVC	Accesorio en T ø 32 DN25	PH660-ORP660	153,78
	TPHIC40C	C-PVC	Accesorio en T ø 40 DN32	PH660-ORP660	159,94
	TPHIC50C	C-PVC	Accesorio en T ø 50 DN40	PH660-ORP660	166,38
	EG66P	C-PVC	Prensaestopas de electrodos macho ¾"	PH660-ORP660	88,34
	MK660	C-PVC	Kit de instalación (adaptador + tapón amarillo) para accesorios FLS hasta DN100 (4")	PH660-ORP660	45,44
	MK150200	C-PVC	Kit de instalación (EG50P + adaptador + tapón amarillo) para accesorios FLS hasta DN100 (4")	PH200C, ORP200C, C150.1, C150.01TC	95,91
	GEG135SE	PP	Prensaestopas para electrodo PG13.5 con protección de cabeza de electrodo 1¼" G.M.	PH430CD, ORP430CD, PH435CD	370,13
	F3.SP2.4	PVC-U	Tapón de electrodo color amarillo para accesorios FLS hasta DN100 (4")	PH223CD, ORP223CD	29,75
	GEG135	PVC-U	Prensaestopas para electrodo PG13.5 o cuerpo de 12 mm y 1½" G.M.	PH-ORP400	35,36
	EG50P	PP	Prensaestopas de electrodo macho ½"	PH-ORP200 (NO para PH223CD, ORP223CD), C150-200, T970278, T970196	47,96
	EG75P	PP	Prensaestopas de electrodo macho ¾"	PH-ORP200 (NO para PH223CD, ORP223CD), 0-200, T970278, T970196	47,96
	EG135FS	PVDF / FKM	Prensaestopas corto p/electrodo PG13.5 ½" PH-ORP430, PH435CD		97,20
	EG135FL	PVDF / FKM	Prensaestopas largo p/electrodo PG13.5 ½" PH-ORP430, PH435CD		106,88

Adaptadores para instalación en inmersión.

	Ref.	Cuerpo	Descripción	Para electrodos	€
	MIFV20X05	PVC-U	Doble toma 20 x 1/2" (tubería suministrada por el cliente)	PH200C-ORP200C (con EG50P), PH222CD ORP222CD (con CN653), (GEG135), PH650 ORP650 (CON CN653), C150-200 (CON EG50P)	5,10
	MIMC20X05	C-PVC	Doble toma 20 x 1/2" (tubería suministrada por el cliente)	PH200C-ORP200C (con EG50P), PH222CD ORP222CD (con CN653), (GEG135), PH650 ORP650 (CON CN653), C150-200 (CON EG50P)	22,71

Adaptadores para toma en carga u horizontal.

	Ref.	Cuerpo	Descripción	Para electrodos	€
	WT675	C-PVC	Prensaestopa de electrodo para instalación con toma en carga: inserción máxima 300 mm (12")	PH655-ORP655	1.081,43
	WT675TC1	C-PVC/SS	Prensaestopa de electrodo para instalación con toma en carga: inserción máxima 300 mm (12")	PH655-ORP655	1.614,92

Recambios para monitor M9.00.

Ref.	Descripción	€
M9.SP4.1	Prensaestopas de cable completo PG11 (2 juntas tóricas y capuchón)	10,83
M9.LN1	Tuerca de bloqueo de plástico para M9.02	54,57
M9.SN1	2 Tornillos de fijación de plástico para instalación en panel de todos los monitores FLS (excepto para M9.02)	54,57
M9.SP7	Recambio de batería 3,6 voltios (2,4 Ah). Batería de litio cloruro de tionilo (sólo para M9.20)	189,81
M9.KUSB	Cable USB para productos FLS, 1,5 metros de longitud	28,03

Recambios para sensor de caudal de paletas F3.00.

Ref.	Descripción	€
F3.SP1	Enchufe de cable de 4 clavijas según DIN 43650	61,89
F3.SP2.1	Tapón negro para sensor versión HALL	29,75
F3.SP2.2	Tapón rojo para sensor versión COIL	29,75
F3.SP2.4	Tapón amarillo para sensor versión PLC	29,75
F3.SP2.6	Tapón en inox AISI 316 para sensor en inox versión HALL y COIL	66,88
F3.SP3.1	Juntas tóricas para cuerpo del sensor en EPDM	5,01
F3.SP3.2	Juntas tóricas para cuerpo del sensor en FKM	7,45
F3.SP4.2	Kit rotor. Rotor en ECTFE (Halar®) con cojinetes y eje en cerámica mecanizada	250,05
F3.SP4.3	Kit rotor. Rotor en ECTFE (Halar®) con eje en acero inox	153,49
F3.SP5.1	Toma de sensor en C-PVC	69,32
F3.SP5.2	Toma de sensor en PVDF	98,35
F3.SP5.3	Toma de sensor en acero inox	37,13
F3.SP6	Cable eléctrico (precio por metro), 22AWG, 3 cond.	5,56

Recambios para sensor de caudal de paletas para altas presiones F3.20

Ref.	Descripción	€
F3.SP4.3	Kit rotor. Rotor en ECTFE (Halar®) con eje en acero inox	153,49
F3.SP8	Kit de juntas y tornillos. Tornillos en acero inox y junta en grafito	64,53

Recambios para transmisor de caudal de paletas F6.30.

Ref.	Descripción	€
F6.KC1	Kit de montaje compacto. Adaptador de plástico con capuchón compacto y tuerca de bloqueo	158,60
M9.SP4.1	Prensaestopas de cable completo PG11 (2 juntas tóricas y capuchón)	10,83
F3.SP3.1	Juntas tóricas para cuerpo del sensor en EPDM	5,01
F3.SP3.2	Juntas tóricas para cuerpo del sensor en FKM	7,45
F6.30.SP1.S	Dispositivo electrónico con salida 4-20 mA y salida de impulsos de frecuencia/volumen para sensor de caudal de paletas	771,95
M9.KUSB	Cable USB para productos FLS, 1,5 metros de longitud	28,03

Recambios para minisensor de caudal de paletas F3.10.

Ref.	Descripción	€
F3.SP2.7	Tapa de sensor gris	11,69
F3.SP3.3	Juntas tóricas para cuerpo del sensor en EPDM	5,10
F3.SP3.4	Juntas tóricas para cuerpo del sensor en FKM	7,55
F3.SP11	Kit rotor. Rotor de PVC con eje en AISI 316L	78,06
M9.KUSB	Cable USB para productos FLS, 1,5 metros de longitud	28,03

Recambios para sensor de caudal de paletas interruptor de caudal (Batch Controller) F3.05.

Ref.	Descripción	€
F3.SP1	Enchufe de cable de 4 clavijas según DIN 43650	61,89
F3.SP2.1	Tapón negro para sensor versión HALL	29,75
F3.SP3.1	Juntas tóricas para cuerpo del sensor en EPDM	5,01
F3.SP3.2	Juntas tóricas para cuerpo del sensor en FKM	7,45
F3.SP4.2	Kit rotor. Rotor en ECTFE (Halar®) con cojinetes y eje en cerámica mecanizada	250,05
F3.SP5.1	Toma de sensor en C-PVC	69,32
F3.SP5.2	Toma de sensor en PVDF	98,35
F3.SP5.3	Toma de sensor en acero inox	37,13



Recambios para sensor de caudal electromagnético para tomas en carga F6.61.

Ref.	Descripción	€
F6.KC1	Kit de montaje compacto. Adaptador de plástico con capuchón compacto y tuerca de bloqueo	158,60
M9.SP4.1	Prensaestopas de cable completo PG11 (2 juntas tóricas y capuchón)	10,83
F1.SP3	Válvula de aislamiento esférica de latón 2"	197,26
F1.SP5	Válvula de aislamiento esférica de latón 1½"	197,26
F1.SP6	Reducción roscada macho-hembra 2"-1 ¼" en acero cincado	20,76
F1.SP7	Reducción roscada macho(NPT)-hembra 2"-1¼" en acero cincado	20,76
F6.60M.SP1.S	Dispositivo electrónico de medición magnética con salida 4-20 mA y salida de impulsos de frecuencia/volumen.	1.467,63
F3.61M.SP01	Sensor de caudal de medidor electromagnético para inserción con toma en carga. Cuerpo en inox 304/PVDF	3.930,19
M9.KUSB	Cable USB para productos FLS, 1,5 metros de longitud	28,03





Recambios para sensor de caudal electromagnético F6.60 R

Ref.	Descripción	€
F6.KC1	Kit de montaje compacto. Adaptador de plástico con capuchón compacto y tuerca de bloqueo	158,60
M9.SP4.1	Prensaestopas de cable completo PG11 (2 juntas tóricas y capuchón)	10,83
F3.SP3.1	Juntas tóricas para cuerpo del sensor en EPDM	5,01
F3.SP3.2	Juntas tóricas para cuerpo del sensor en FKM	7,45
F6.60.SP1.S	Dispositivo electrónico de medición magnética con salida 4-20 mA y salida de impulsos de frec./volum. para sensor bidireccional	1.467,63
F3.60M.SP09	Sensor de caudal bidireccional p/medidor electromagn. Cuerpo en inox 316L/PVDF. Juntas tóricas en EPDM. Long. L0	1.046,62
F3.60M.SP10	Sensor de caudal bidireccional p/medidor electromagn. Cuerpo en inox 316L/PVDF. Juntas tóricas en FKM. Long. L0	1.328,56
F3.60M.SP11	Sensor de caudal bidireccional p/medidor electromagn. Cuerpo en inox 316L/PVDF. Juntas tóricas en EPDM. Long. L1	1.416,16
F3.60M.SP12	Sensor de caudal bidireccional p/medidor electromagn. Cuerpo en inox 316L/PVDF. Juntas tóricas en FKM. Long. L1	1.416,16
F3.60M.SP13	Sensor de caudal bidireccional p/medidor electromagn. Cuerpo en CuNi/PVDF. Juntas tóricas en EPDM. Long. L0	1.532,98
F3.60M.SP14	Sensor de caudal bidireccional p/medidor electromagn. Cuerpo en CuNi/PVDF. Juntas tóricas en FKM. Long. L0	1.532,98
F3.60M.SP15	Sensor de caudal bidireccional p/medidor electromagn. Cuerpo en CuNi/PVDF. Juntas tóricas en EPDM. Long. L1	1.620,57
F3.60M.SP16	Sensor de caudal bidireccional p/medidor electromagn. Cuerpo en CuNi/PVDF. Juntas tóricas en FKM. Long. L1	1.620,57
F3.60M.SP17	Sensor de caudal bidireccional p/medidor electromagn. Cuerpo en inox316L/PEEK. Juntas tóricas en FKM. Long. L0	1.532,98
F3.60M.SP18	Sensor de caudal bidireccional p/medidor electromagn. Cuerpo en inox316L/PEEK. Juntas tóricas en FKM. Long. L1	1.620,57
M9.KUSB	Cable USB para productos FLS, 1,5 metros de longitud	28,03



Recambios para monitor M9.00.

Ref.	Descripción	€
 F6.KC1	Kit de montaje compacto. Adaptador de plástico con capuchón compacto y tuerca de bloqueo (sólo para monitor M9.02)	158,60
 M9.KW1	Kit de montaje mural. Caja plástica de 144 x 144 mm para instalación mural de todos los monitores de montaje en panel	232,09
M9.KW2	Kit de montaje mural con alimentación. Caja plástica de 144 x 144 mm para instalación mural de todos los monitores de montaje en panel y fuente de alimentación de 110/230 VAC a 24DC incluida	451,26
M9.KUSB	Cable USB para productos FLS 1,5 metros de longitud	28,03

Recambios para electrodos de pH/ORP

	Ref.	Descripción	€
	CN653	Montaje cable universal de 5 metros. Para electrodos: PH222CD, OPR222CD, ORP223CD, PH-ORP600	314,87
	CN65310M	Montaje cable universal de 10 metros. Para electrodos: PH222CD, OPR222CD, ORP223CD, PH-ORP600	389,12
	CN65315M	Montaje cable universal de 15 metros. Para electrodos: PH222CD, OPR222CD, ORP223CD, PH-ORP600	463,34
	CN653TC1	Montaje de cable sumergible de 5 metros con compensación de temperatura. Para electrodos PH222CD, PH223CD, PH650CD, PH650CDHF, PH650CDDA, PH650CDLC	694,91
	CE5S7	Montaje cable de 5 metros. Para electrodos: PH435CD, PH430CD, ORP430CD	237,62
	CE10S7	Montaje cable de 10 metros. Para electrodos: PH435CD, PH430CD, ORP430CD	282,20
	CE15S7	Montaje cable de 15 metros. Para electrodos: PH435CD, PH430CD, ORP430CD	326,75
	B104	Solución tampón pH 4,01	80,18
	B107	Solución tampón pH 7,00	80,18
	B110	Solución tampón pH 10,00	80,18
	B3KCL	Solución tampón pH solución 3KCl	95,74
	B475	Solución tampón ORP 475 mV	80,18

Recambios para sensores de conductividad.

	Ref.	Descripción	€
	T970278	Sensor de temperatura PT100 con dos cables (5 metros) y cuerpo epóxico **	222,77
	T970196	Sensor de temperatura PT100 con dos cables (5 metros) y cuerpo epóxico ** (sin metal ni contacto)	564,35
	B0018	Solución tampón de conductividad para calibración de baja conductividad (18 microsiemens)	133,66
	B1417	Solución tampón de conductividad para calibración de conductividad (1.417 microsiemens)	210,66

** +5 € / metro cable

Tubo y accesorios
Válvulas manuales
Válvulas actuadas
Válvulas de control de presión



0805

Sistema PP-H Socket

INDUSTRIA



Más información



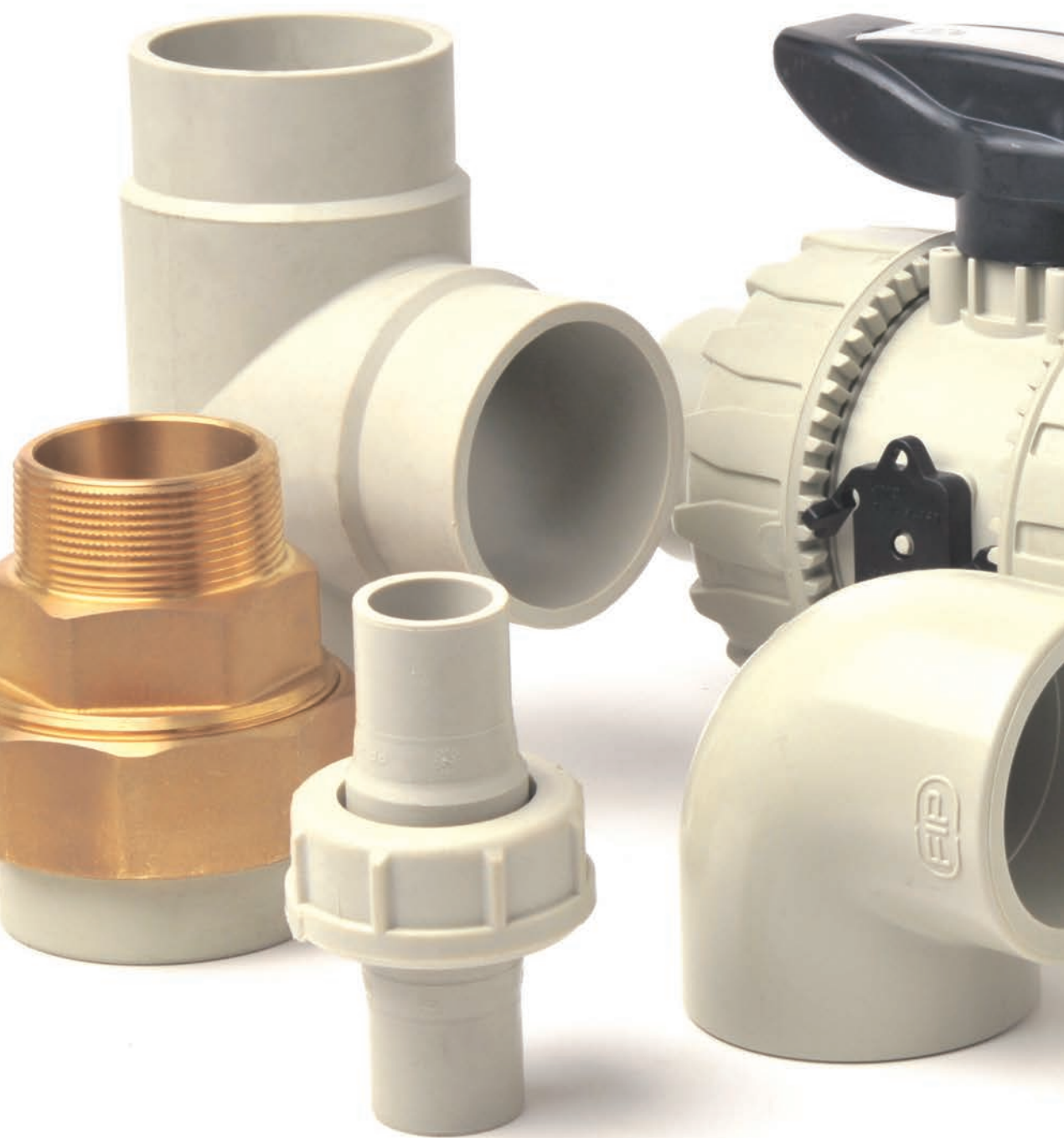

Sistema PP-H Socket

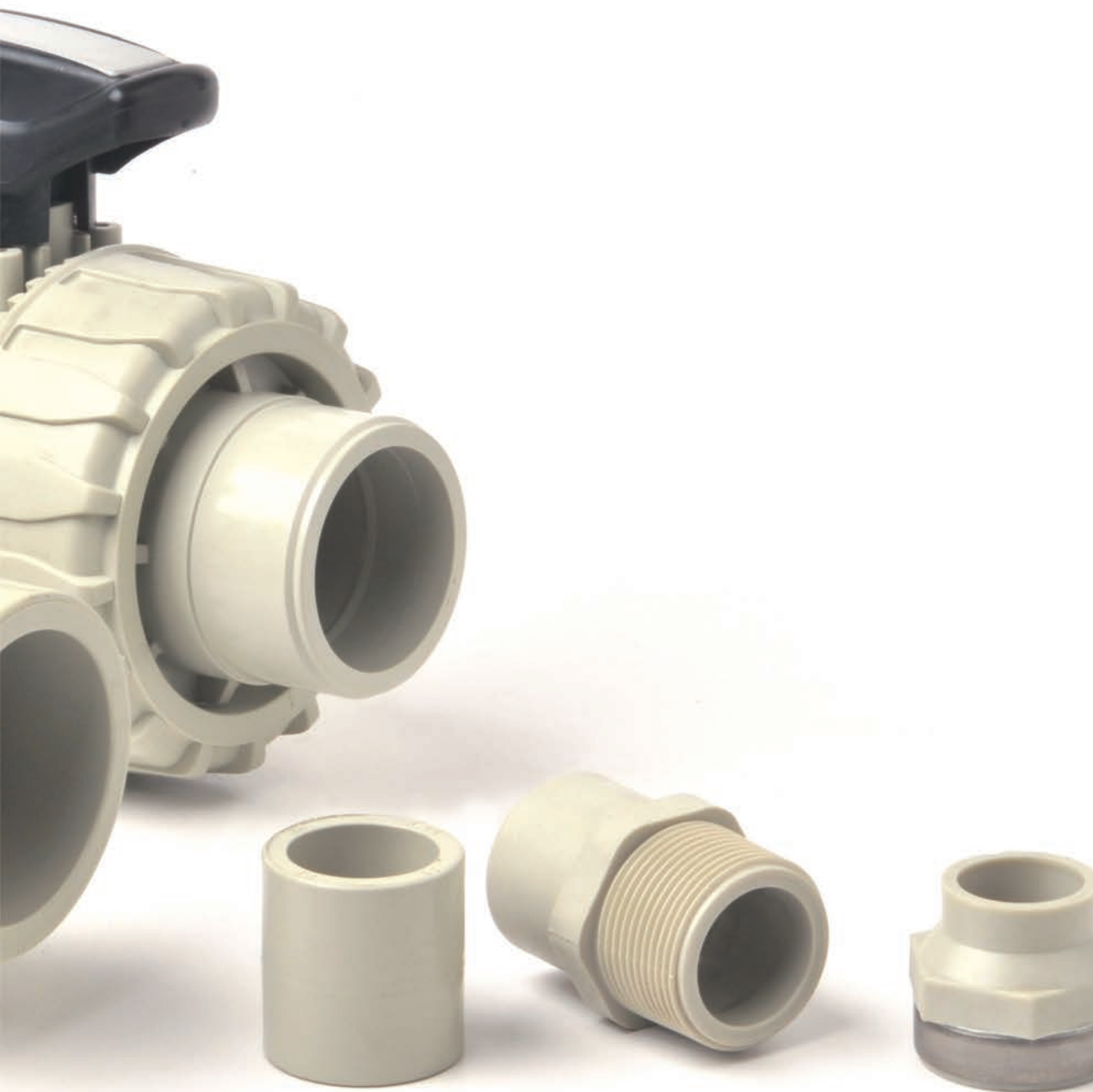



INDUSTRIA

Sistema PP-H Socket

Tubo



d	Ref.	Espesor	Longitud barras	€/m.
25	PIPEM17025	1,8	5 m.	1,56
32	PIPEM17032	1,9	5 m.	1,96
40	PIPEM17040	2,3	5 m.	3,14
50	PIPEM17050	2,9	5 m.	4,76
63	PIPEM17063	3,6	5 m.	7,40
75	PIPEM17075	4,3	5 m.	10,49
90	PIPEM17090	5,1	5 m.	14,92
110	PIPEM17110	6,3	5 m.	22,32
125	PIPEM17125	7,1	5 m.	28,60
140	PIPEM17140	8,0	5 m.	35,90
160	PIPEM17160	9,1	5 m.	46,74
180	PIPEM17180	10,2	5 m.	73,50
200	PIPEM17200	11,4	5 m.	87,79
225	PIPEM17225	12,8	5 m.	114,75
250	PIPEM17250	14,2	5 m.	144,01
280	PIPEM17280	15,9	5 m.	176,58
315	PIPEM17315	17,9	5 m.	224,49
355	PIPEM17355	20,1	5 m.	334,25
355	PIPEM17355	20,1	5 m.	334,25
400	PIPEM17400	22,7	5 m.	421,17
400	PIPEM17400	22,7	5 m.	421,17
450	PIPEM17450	25,5	5 m.	585,28
500	PIPEM17500	28,4	5 m.	723,87
560	PIPEM17560	31,7	5 m.	1.044,64
630	PIPEM17630	35,7	5 m.	1.323,52
710	PIPEM17710	40,2	5 m.	1.678,53
800	PIPEM17800	45,3	5 m.	2.139,41

Tubo PP-H (100) SDR17,6 (PN6).

Para soldar socket y a testa. Para otros diámetros consultar disponibilidad.

d	Ref.	Espesor	Longitud barras	€/m.
20	PIPEM11020	1,9	5 m.	1,25
25	PIPEM11025	2,3	5 m.	1,93
32	PIPEM11032	2,9	5 m.	2,99
40	PIPEM11040	3,7	5 m.	4,70
50	PIPEM11050	4,6	5 m.	7,16
63	PIPEM11063	5,8	5 m.	11,33
75	PIPEM11075	6,8	5 m.	15,69
90	PIPEM11090	8,2	5 m.	22,76
110	PIPEM11110	10,0	5 m.	33,75
125	PIPEM11125	11,4	5 m.	50,29
140	PIPEM11140	12,7	5 m.	62,61
160	PIPEM11160	14,6	5 m.	71,63
180	PIPEM11180	16,4	5 m.	112,91
200	PIPEM11200	18,2	5 m.	136,99
225	PIPEM11225	20,5	5 m.	174,07
250	PIPEM11250	22,7	5 m.	221,48
280	PIPEM11280	25,4	5 m.	267,14
315	PIPEM11315	28,6	5 m.	344,71
355	PIPEM11355	32,3	5 m.	522,85
400	PIPEM11400	39,5	5 m.	659,49
450	PIPEM11450	40,9	5 m.	914,30
500	PIPEM11500	45,9	5 m.	1.127,77

Tubo PP-H (100) SDR11 (PN10).

Para soldar socket y a testa. Para otros diámetros consultar disponibilidad.



TIM

d	Ref.	Pack	€
20	TIM020	10	4,20
25	TIM025	10	4,65
32	TIM032	10	5,42
40	TIM040	5	6,94
50	TIM050	5	12,41
63	TIM063	2	15,84
75	TIM075	-	36,76
90	TIM090	-	59,37
110	TIM110	-	75,34

Te a 90°.
 H-H para fusión socket.



GIM

d	Ref.	Pack	€
20	GIM020	10	3,56
25	GIM025	10	4,20
32	GIM032	10	5,07
40	GIM040	5	6,47
50	GIM050	5	11,91
63	GIM063	2	15,48
75	GIM075	-	32,17
90	GIM090	-	39,59
110	GIM110	-	59,37

Codo 90°.
 H-H para fusión socket.



HIM

d	Ref.	Pack	€
20	HIM020	10	5,07
25	HIM025	10	5,42
32	HIM032	10	6,68
40	HIM040	5	9,24
50	HIM050	5	11,91
63	HIM063	2	15,84
75	HIM075	-	36,76
90	HIM090	-	50,74
110	HIM110	-	74,21

Codo 45°.
 H-H para fusión socket.



MIM

d	Ref.	Pack	€
20	MIM020	10	2,45
25	MIM025	10	2,80
32	MIM032	10	3,22
40	MIM040	5	3,88
50	MIM050	5	7,45
63	MIM063	2	11,30
75	MIM075	-	15,74
90	MIM090	-	22,47
110	MIM110	-	35,29

Manguito.
 H-H para fusión socket.

MIMM



d x Rh	Ref.	Pack	€
20 x 1/2"	MIMM020012	10	4,78
25 x 3/4"	MIMM025034	10	6,08
32 x 1"	MIMM032100	10	7,71
40 x 1 1/4"	MIMM040114	5	9,24
50 x 1 1/2"	MIMM050112	5	15,21
63 x 2"	MIMM063200	2	19,25

Manguito mixto reforzado.
H-H para fusión socket-rosca.

QRNM



d	Ref.	Pack	€
20	QRNM020	10	5,96
25	QRNM025	10	6,23
32	QRNM032	10	6,76
40	QRNM040	5	8,32
50	QRNM050	5	9,72
63	QRNM063	2	12,07
75	QRNM075	-	26,12
90	QRNM090	-	41,25
110	QRNM110	-	57,10

Manguito portabridas estriado.
H para fusión socket.

ODC



d	Ref.	DN	€
20	ODC020	15	7,31
25	ODC025	20	8,70
32	ODC032	25	10,09
40	ODC040	32	12,34
50	ODC050	40	15,94
63	ODC063	50	17,75
75	ODC075	65	26,42
90	ODC090	80	29,20
110	ODC110	100	40,10

Brida loca.
UNI 2223 PN10.
En C-PVC para manguito portabridas.
Descuento de la familia C-PVC

RIM



dm x dh	Ref.	Pack	€
25 x 20	RIM025020	10	3,46
32 x 20	RIM032020	10	4,20
32 x 25	RIM032025	10	4,20
40 x 25	RIM040025	10	5,00
40 x 32	RIM040032	10	5,00
50 x 32	RIM050032	5	6,47
50 x 40	RIM050040	5	6,31
63 x 32	RIM063032	5	7,53
63 x 50	RIM063050	5	7,71
75 x 50	RIM075050	-	13,81
75 x 63	RIM075063	-	13,81
90 x 63	RIM090063	-	19,25
90 x 75	RIM090075	-	18,93
110 x 63	RIM110063	-	26,41
110 x 90	RIM110090	-	27,25

Reducción cónica.
M-H para fusión socket.

GRAM



d	Ref.	Pack	€
3/4"	GRAM034	10	7,45
1"	GRAM100	10	8,09
1 1/4"	GRAM114	10	10,08
1 1/2"	GRAM112	5	11,67
3"	GRAM300	-	49,52

Manguito portabridas estriado ANSI 150 lbs.
H para fusión socket.

ODB



d	Ref.	DN	€
20	ODB020	15	8,85
25	ODB025	20	9,72
32	ODB032	25	12,51
40	ODB040	32	15,18
50	ODB050	40	17,75
63	ODB063	50	22,08
75	ODB075	65	24,40
90	ODB090	80	29,06
**125	ODB125	100	35,07

Brida loca.
En PP con alma de acero.
PN10. Para manguito portabridas.
Versión ANSI 150 lbs (ver OAB página 320)

Más diámetros en página 320
** Para usar con portabridas QRNM110



CIM

d	Ref.	Pack	€
20	CIM020	10	3,22
25	CIM025	10	3,22
32	CIM032	10	4,02
40	CIM040	5	4,73
50	CIM050	5	6,76
63	CIM063	2	8,74
75	CIM075	-	16,01
90	CIM090	-	18,54
110	CIM110	-	25,65

Tapón.

H para fusión socket.



AIM

d x P1 x P2	Ref.	Pack	€
20 x 22 x 20	AIM020022020	10	3,65
25 x 27 x 25	AIM025027025	10	4,65
32 x 32 x 30	AIM032032030	10	5,65
40 x 42 x 40	AIM040042040	5	9,80
50 x 52 x 50	AIM050052050	5	12,21
63 x 64 x 60	AIM063064060	5	13,58

Espiga.

M para fusión socket.



BIGM

d	Ref.	Pack	€	
			EPDM	FKM
20	BIGM020E	10	14,00	16,21
25	BIGM025E	10	15,48	17,75
32	BIGM032E	10	17,75	21,02
40	BIGM040E	2	22,47	28,15
50	BIGM050E	2	32,12	39,59
63	BIGM063E	2	45,79	54,56

Unión 3 piezas.

H-H para fusión socket.

Código en FKM termina en "F"
en lugar de "E"



BIFGM

d x Rh	Ref.	Pack	€	
			EPDM	FKM
20 x 1/2"	BIFGM020012E	10	21,02	24,62
25 x 3/4"	BIFGM025034E	10	23,13	26,49
32 x 1"	BIFGM032100E	10	24,22	28,94
40 x 1 1/4"	BIFGM040114E	2	37,82	48,07
50 x 1 1/2"	BIFGM050112E	2	55,30	68,62
63 x 2"	BIFGM063200E	2	63,52	75,34

Unión 3 piezas.

H-H para fusión socket-rosocar.

Código en FKM termina en "F"
en lugar de "E"



BIFOM

d x Rh	Ref.	Pack	€
			EPDM
20 x 1/2"	BIFOM020012E	40	24,64
25 x 3/4"	BIFOM025034E	16	30,02
32 x 1"	BIFOM032100E	10	37,55
40 x 1 1/4"	BIFOM040114E	8	46,32
50 x 1 1/2"	BIFOM050112E	4	59,79
63 x 2"	BIFOM063200E	-	77,64

Unión 3 piezas mixto PP-H / latón.

Junta en EPDM.

H-H para fusión socket-rosocar latón.



BIROM

d x Rm	Ref.	Pack	€
			EPDM
20 x 1/2"	BIROM020012E	35	27,73
25 x 3/4"	BIROM025034E	15	33,52
32 x 1"	BIROM032100E	8	43,04
40 x 1 1/4"	BIROM040114E	8	56,80
50 x 1 1/2"	BIROM050112E	4	69,96
63 x 2"	BIROM063200E	-	90,22

Unión 3 piezas mixto PP-H / latón.

Junta en EPDM.

H-M para fusión socket-rosocar latón.



INDUSTRIA

Sistema PP-H Socket

Válvulas de bola



VKDIM



d	Ref. EPDM	DN	€	
			EPDM	FKM
16	VKDIM016E	10	71,49	86,39
20	VKDIM020E	15	71,71	86,52
25	VKDIM025E	20	84,65	100,28
32	VKDIM032E	25	104,56	127,87
40	VKDIM040E	32	129,54	155,61
50	VKDIM050E	40	167,67	197,79
63	VKDIM063E	50	209,06	264,37

Válvula de bola DUAL BLOCK®. Código en FKM termina en "F" en lugar de "E"
Asiento PTFE (teflón). Bidireccional.
H-H para fusión socket.

VKDFM



Rh	Ref. EPDM	DN	€	
			EPDM	FKM
½"	VKDFM012E	15	84,65	100,28
¾"	VKDFM034E	20	95,03	111,53
1"	VKDFM100E	25	134,80	152,02
1¼"	VKDFM114E	32	143,32	172,77
1½"	VKDFM112E	40	184,87	216,01
2"	VKDFM200E	50	236,80	293,82

Válvula de bola DUAL BLOCK®. Código en FKM termina en "F" en lugar de "E"
Asiento PTFE (teflón). Bidireccional.
H-H roscar.

VKDIM



d	Ref. EPDM	DN	€	
			EPDM	FKM
75	VKDIM075E	65	502,42	750,79
90	VKDIM090E	80	631,52	941,39
110	VKDIM110E	100	764,60	929,33

Válvula de bola DUAL BLOCK®. Código en FKM termina en "F" en lugar de "E"
Asiento PTFE (teflón). Bidireccional.
H-H para fusión socket.

VKDDM



d	Ref. EPDM	DN	€	
			EPDM	FKM
20	VKDDM020E	15	71,71	86,52
25	VKDDM025E	20	84,65	100,28
32	VKDDM032E	25	104,56	127,87
40	VKDDM040E	32	129,54	155,61
50	VKDDM050E	40	167,67	197,79
63	VKDDM063E	50	209,06	264,37

Válvula de bola DUAL BLOCK®. Código en FKM termina en "F" en lugar de "E"
Asiento PTFE (teflón). Bidireccional.
M-M para fusión socket.

VKDOM



d	Ref. EPDM	DN	€	
			EPDM	FKM
20	VKDOM020E	15	144,57	166,99
25	VKDOM025E	20	169,85	192,37
32	VKDOM032E	25	212,45	245,70
40	VKDOM040E	32	277,22	312,90
50	VKDOM050E	40	328,81	354,69
63	VKDOM063E	50	405,45	470,18

Válvula de bola DUAL BLOCK®. Código en FKM termina en "F" en lugar de "E"
Con brida loca. Asiento PTFE (teflón). Versión con bridas ANSI 150 lbs al mismo precio.
Bidireccional.

VKDOM



d	Ref. EPDM	DN	€	
			EPDM	FKM
75	VKDOM075E	65	678,30	809,39
90	VKDOM090E	80	852,57	1.017,32
110	VKDOM110E	100	1.032,21	1.196,94

Válvula de bola DUAL BLOCK®. Código en FKM termina en "F" en lugar de "E"
Con brida loca. Asiento PTFE (teflón). ANSI y DIN
Bidireccional.

VKDDM



d	Ref. EPDM	DN	€	
			EPDM	FKM
75	VKDDM075E	65	502,42	633,50
90	VKDDM090E	80	631,52	796,34
110	VKDDM110E	100	764,60	929,33

Válvula de bola DUAL BLOCK®. Código en FKM termina en "F" en lugar de "E"
Asiento PTFE (teflón). Bidireccional.
M-M para fusión socket.



VKRIM

d	Ref. EPDM	DN	€	
			EPDM	FKM
16	VKRIM016E	10	292,74	307,60
20	VKRIM020E	15	292,89	307,70
25	VKRIM025E	20	324,60	340,24
32	VKRIM032E	25	382,63	405,97
40	VKRIM040E	32	428,75	454,84
50	VKRIM050E	40	532,17	562,33
63	VKRIM063E	50	566,40	621,75

Válvula de bola REGULACIÓN DUAL BLOCK®.

Asiento PTFE (teflón). Bidireccional H-H para fusión socket.

Código en FKM termina en "F" en lugar de "E"



VKRFM

Rh	Ref. EPDM	DN	€	
			EPDM	FKM
3/8"	VKRFM038E	10	305,83	321,49
1/2"	VKRFM012E	15	305,83	321,49
3/4"	VKRFM034E	20	334,97	351,47
1"	VKRFM100E	25	412,95	430,15
1 1/4"	VKRFM114E	32	442,56	471,98
1 1/2"	VKRFM112E	40	549,33	580,50
2"	VKRFM200E	50	594,12	651,18

Válvula de bola REGULACIÓN DUAL BLOCK®.

Asiento PTFE (teflón). Bidireccional H-H roscar.

Código en FKM termina en "F" en lugar de "E"



VKDBM

d	Ref. EPDM	DN	€	
			EPDM	FKM
20	VKDBM020E	15	79,46	95,03
25	VKDBM025E	20	93,34	111,56
32	VKDBM032E	25	113,20	139,86
40	VKDBM040E	32	141,61	172,77
50	VKDBM050E	40	183,15	217,72
63	VKDBM063E	50	228,13	291,96

Válvula de bola DUAL BLOCK®.

Asiento PTFE (teflón). Bidireccional M-M para soldadura a testa.

Código en FKM termina en "F" en lugar de "E"



VKDBEM

d	Ref. EPDM	DN	€	
			EPDM	FKM
20	VKDBEM020E	15	79,46	95,03
25	VKDBEM025E	20	93,34	111,53
32	VKDBEM032E	25	113,20	139,86
40	VKDBEM040E	32	141,61	172,77
50	VKDBEM050E	40	183,15	217,72
63	VKDBEM063E	50	228,13	291,96

Válvula de bola DUAL BLOCK®.

Asiento PTFE (teflón). Bidireccional M-M para soldadura a testa.

Código en FKM termina en "F" en lugar de "E"



VKDBM

d	Ref. EPDM	DN	€	
			EPDM	FKM
75	VKDBM075E	65	552,13	683,23
90	VKDBM090E	80	695,06	859,83
110	VKDBM110E	100	839,95	1.004,70

Válvula de bola DUAL BLOCK®.

Asiento PTFE (teflón). Bidireccional M-M para soldadura a testa.

Código en FKM termina en "F" en lugar de "E"



VKDBEM

d	Ref. EPDM	DN	€	
			EPDM	FKM
75	VKDBEM075E	65	552,13	683,23
90	VKDBEM090E	80	695,06	859,83
110	VKDBEM110E	100	839,95	1.004,70

Válvula de bola DUAL BLOCK®.

Asiento PTFE (teflón). Bidireccional Long spigot PE100 SDR11.

Código en FKM termina en "F" en lugar de "E"



Sistema PP-H Socket Válvulas de 3 vías



VKROM

d	Ref. EPDM	DN	€ EPDM	€ FKM
20	VKROM020E	15	365,80	388,21
25	VKROM025E	20	409,79	432,31
32	VKROM032E	25	490,55	523,85
40	VKROM040E	32	576,46	612,11
50	VKROM050E	40	693,29	719,21
63	VKROM063E	50	762,81	827,51

Válvula de bola **REGULACIÓN**
DUAL BLOCK®.
Asiento PTFE (teflón). Bidireccional
Con Brida DIN 2501

Código en FKM termina en "F"
en lugar de "E"



VKROAM

d	Ref. EPDM	DN	€ EPDM	€ FKM
½"	VKROAM012E	15	365,80	388,21
¾"	VKROAM034E	20	409,79	432,31
1"	VKROAM100E	25	490,55	523,85
1¼"	VKROAM114E	32	576,46	612,11
1½"	VKROAM112E	40	693,29	719,21
2"	VKROAM200E	50	762,81	762,81

Válvula de bola **REGULACIÓN**
DUAL BLOCK®.
Asiento PTFE (teflón). Bidireccional
Con bridas ANSI 150 lbs.

Código en FKM termina en "F"
en lugar de "E"



TKDIM

d x d x Rh	Ref. EPDM	DN	Apertura	€ EPDM
32 x 32 x ¼"	TKDIM032ED	25	Derecha	Consultar
32 x 32 x ¼"	TKDIM032ES	25	Izquierda	Consultar

Válvula de bola 3 vías
DESALACIÓN DUAL BLOCK®.
H-H-H para fusión socket-rosca 1/4"
toma muestras. Asiento PTFE (teflón).

Bajo pedido
suministramos otros diámetros
Disponibles también
con juntas en FKM



TKDIM

d	Ref. EPDM	DN	€ EPDM	€ FKM
20	TKDIM020E	15	128,62	145,33
25	TKDIM025E	20	144,52	166,17
32	TKDIM032E	25	185,43	213,24
40	TKDIM040E	32	211,52	249,58
50	TKDIM050E	40	250,37	312,97
63	TKDIM063E	50	316,58	395,71

Válvula de bola 3 vías
DUAL BLOCK®. **PASO T.**
H-H-H para fusión socket. Asiento PTFE
(teflón).

Código en FKM termina en "F"
en lugar de "E"



TKDFM

Rh	Ref. EPDM	DN	€ EPDM	€ FKM
½"	TKDFM012E	15	143,14	159,87
¾"	TKDFM034E	20	161,18	182,84
1"	TKDFM100E	25	206,76	234,60
1¼"	TKDFM114E	32	236,51	274,56
1½"	TKDFM112E	40	281,64	344,17
2"	TKDFM200E	50	356,19	435,32

Válvula de bola 3 vías
DUAL BLOCK®. **PASO T.**
H-H-H rosca. Asiento PTFE (teflón).

Código en FKM termina en "F"
en lugar de "E"



LKDIM

d	Ref. EPDM	DN	€ EPDM	€ FKM
20	LKDIM020E	15	150,38	167,15
25	LKDIM025E	20	169,48	191,13
32	LKDIM032E	25	217,43	245,29
40	LKDIM040E	32	249,04	287,08
50	LKDIM050E	40	297,25	359,86
63	LKDIM063E	50	375,90	455,13

Válvula de bola 3 vías
DUAL BLOCK®. **PASO L.**
H-H-H para fusión socket. Asiento PTFE
(teflón).

Código en FKM termina en "F"
en lugar de "E"



INDUSTRIA

Sistema PP-H Socket

Válvulas de mariposa



LKDFM

Rh	Ref. EPDM	DN	€ EPDM	€ FKM
1/2"	LKDFM012E	15	164,90	181,65
3/4"	LKDFM034E	20	186,09	207,74
1"	LKDFM100E	25	238,74	266,58
1 1/4"	LKDFM114E	32	273,90	312,04
1 1/2"	LKDFM112E	40	328,60	391,11
2"	LKDFM200E	50	415,48	494,67

Válvula de bola 3 vías
DUAL BLOCK®. **PASO L.**
H-H-H roscar. Asiento PTFE (teflón).

Código en FKM termina en "F"
en lugar de "E"



SETFLOM

d DIN	d ANSI	Ref. DIN	€ DIN 2501	€ ANSI
20	1/2"	SETFLOM020	52,38	52,38
25	3/4"	SETFLOM025	60,55	60,55
32	1"	SETFLOM032	66,48	66,48
40	1 1/4"	SETFLOM040	88,11	88,11
50	1 1/2"	SETFLOM050	91,64	91,64
63	2"	SETFLOM063	117,08	117,08
75	2 1/2"	SETFLOM075	260,83	260,83
90	3"	SETFLOM090	316,92	316,92
110	4"	SETFLOM110	370,33	370,33

Set embridado
Compuesto por 1 brida, 1 anillo fijación y 1 tuerca.
Para Válvulas VKD / VKR / TKD / RVU / VRU .

d. 75-90-110,
es el mismo artículo
para DIN y ANSI



FKOM/FM

d	Ref. EPDM	DN	€ EPDM	€ FKM
50	FKOMFM050E	40	332,40	501,16
63	FKOMFM063E	50	351,99	530,67
75	FKOMFM075E	65	391,11	589,58
90	FKOMFM090E	80	425,15	632,57
110	FKOMFM110E	100	462,20	676,98
125	FKOMFM140E	125	613,30	906,62
140	FKOMFM140E	125	613,30	906,62
160	FKOMFM160E	150	676,98	973,30
200	FKOMFM225E	200	876,98	1.263,66
225	FKOMFM225E	200	876,98	1.263,66
250**	FKOMFM280E	250	2.794,31	4.521,80
280**	FKOMFM280E	250	2.794,31	4.521,80
315**	FKOMFM315E	300	3.047,69	4.930,76
355**	FKOMFM355E	350	4.787,71	8.706,17
400**	FKOMFM400E	400	5.530,02	11.185,88

Válvula de mariposa industrial.
A EJE LIBRE.

Para actuar. Cuerpo en PPGR,
eje inoxidable y disco en PP-H.

Código en FKM termina en "F"
en lugar de "E"

** ANSI 150 lbs bajo pedido
al mismo precio.



FKOM/LM

d	Ref. EPDM	DN	€ EPDM	€ FKM
50	FKOMLM050E	40	390,34	556,59
63	FKOMLM063E	50	413,30	589,29
75	FKOMLM075E	65	459,23	654,76
90	FKOMLM090E	80	482,92	687,38
110	FKOMLM110E	100	524,42	734,76
125	FKOMLM140E	125	696,25	985,10
140	FKOMLM140E	125	696,25	985,10
160	FKOMLM160E	150	752,51	1.025,12
200	FKOMLM225E	200	974,72	1.330,29
225	FKOMLM225E	200	974,72	1.330,29

Válvula de mariposa industrial.

CON MANETA.

Cuerpo en PPGR,
eje inoxidable y disco en PP-H.

Código en FKM termina en "F"
en lugar de "E"



FKOM/RM

d	Ref. EPDM	DN	€ EPDM	€ FKM
75	FKOMRM075E	65	1.044,53	1.248,81
90	FKOMRM090E	80	1.078,44	1.281,42
110	FKOMRM110E	100	1.119,88	1.330,29
125	FKOMRM140E	125	1.291,81	1.580,66
140	FKOMRM140E	125	1.291,81	1.580,66
160	FKOMRM160E	150	1.348,08	1.620,66
200	FKOMRM225E	200	1.705,10	2.040,63
225	FKOMRM225E	200	1.705,10	2.040,63
250**	FKOMRM280E	250	3.186,77	4.897,59
280**	FKOMRM280E	250	3.186,77	4.897,59
315**	FKOMRM315E	300	3.471,39	5.354,47
355**	FKOMRM355E	350	5.880,08	9.703,44
400**	FKOMRM400E	400	6.622,40	12.278,24

Válvula de mariposa industrial.

CON VOLANTE.

Cuerpo en PPGR,

eje inoxidable y disco en PP-H.

Código en FKM termina en "F"
en lugar de "E"** ANSI 150 lbs bajo pedido
al mismo precio.

FKOM/RM

d	Ref. EPDM	DN	€ EPDM	€ FKM
75	FKOLMRM075E	65	1.238,43	1.418,59
90	FKOLMRM090E	80	1.318,48	1.506,59
110	FKOLMRM110E	100	1.380,70	1.575,56
125	FKOLMRM140E	125	1.639,89	1.910,04
140	FKOLMRM140E	125	1.639,89	1.910,04
160	FKOLMRM160E	150	1.724,41	1.977,51
200	FKOLMRM225E	200	2.094,68	2.426,43
225	FKOLMRM225E	200	2.094,68	2.426,43

Válvula de mariposa industrial.

CON VOLANTE. LUG ISO-DIN

Cuerpo en PPGR,

eje inoxidable y disco en PP-H.

Código en FKM termina en "F"
en lugar de "E"

FKOM/LM

d	Ref. EPDM	DN	€ EPDM	€ FKM
75	FKOLMLM075E	65	636,69	830,33
90	FKOLMLM090E	80	715,91	927,37
110	FKOLMLM110E	100	777,53	995,54
125	FKOLMLM140E	125	1.034,20	1.320,27
140	FKOLMLM140E	125	1.034,20	1.320,27
160	FKOLMLM160E	150	1.117,89	1.387,80
200	FKOLMLM225E	200	1.351,16	1.703,19
225	FKOLMLM225E	200	1.351,16	1.703,19

Válvula de mariposa industrial.

CON MANETA. LUG ISO-DIN

Cuerpo en PPGR,

eje inoxidable y disco en PP-H.

Código en FKM termina en "F"
en lugar de "E"

FKOM/LM

d	Ref. EPDM	DN	€ EPDM	€ FKM
½"	FKOALMLM212E	65	727,63	921,24
3"	FKOALMLM300E	80	811,19	1.013,70
4"	FKOALMLM400E	100	881,70	1.100,65
5"	FKOALMLM500E	125	1.172,11	1.458,21
6"	FKOALMLM600E	150	1.267,49	1.537,41
8"	FKOALMLM800E	200	1.543,21	1.895,31

Válvula de mariposa industrial.

CON MANETA. LUG ANSI

Cuerpo en PPGR,

eje inoxidable y disco en PP-H.

Código en FKM termina en "F"
en lugar de "E"

FKOM/RM

d	Ref. EPDM	DN	€ EPDM	€ FKM
2½"	FKOALMRM212E	65	1.317,37	1.509,55
3"	FKOALMRM300E	80	1.400,98	1.601,95
4"	FKOALMRM400E	100	1.471,39	1.679,76
5"	FKOALMRM500E	125	1.761,91	2.047,89
6"	FKOALMRM600E	150	1.857,27	2.127,15
8"	FKOALMRM800E	200	2.266,47	2.618,57
10"	FKOALMRM810E	250	5.036,42	6.747,22
12"	FKOALMRM812E	300	5.329,65	7.194,48

Válvula de mariposa industrial.

CON VOLANTE. LUG ANSI

Cuerpo en PPGR,

eje inoxidable y disco en PP-H.

Código en FKM termina en "F"
en lugar de "E"



DKDM

d	Ref. EPDM	DN	PN	€ EPDM	€ FKM	€ PTFE
20	DKDM020E	15	10	140,74	217,89	250,74
25	DKDM025E	20	10	152,34	233,34	264,24
32	DKDM032E	25	10	179,30	258,34	289,30
40	DKDM040E	32	10	210,12	341,35	377,82
50	DKDM050E	40	10	273,74	404,94	441,45
63	DKDM063E	50	10	331,71	553,33	549,57
75	DKDM075E	65	10	398,08	663,96	659,47

Válvula de membrana
DIALOCK®.
M-M para soldar socket.

Código en FKM termina en "F"
en lugar de "E"
Código en PTFE termina en "P"
en lugar de "E"



DKOM

d	Ref. EPDM	DN	PN	€ EPDM	€ FKM	€ PTFE
20	DKOM020E	15	10	213,11	290,24	323,05
25	DKOM025E	20	10	228,95	309,95	340,88
32	DKOM032E	25	10	258,58	337,62	368,55
40	DKOM040E	32	10	314,60	445,80	482,28
50	DKOM050E	40	10	383,03	514,16	550,68
63	DKOM063E	50	10	483,34	705,02	701,19
75	DKOM075E	65	10	628,33	916,48	911,50

Válvula de membrana
DIALOCK®.
Con bridas DIN.

Código en FKM termina en "F"
en lugar de "E"
Código en PTFE termina en "P"
en lugar de "E"



VMDM

d	Ref. EPDM	DN	€ EPDM	€ FKM	€ PTFE
90	VMDM090E	80	885,01	1.517,41	1.179,96
110	VMDM110E	100	1.176,18	2.224,95	1.540,51

Válvula de membrana.
M-M para fusión socket.

Código en FKM termina en "F"
en lugar de "E"
Código en PTFE termina en "P"
en lugar de "E"
*PN6



VMOM

d	Ref. EPDM	DN	€ EPDM	€ FKM	€ PTFE
90	VMOM090E	80	1.182,78	1.815,15	1.477,78
110	VMOM110E	100	1.514,68	2.563,45	1.879,01

Válvula de membrana.
Con bridas DIN. Bajo pedido
con bridas ANSI 150 lbs. mismo precio.

Código en FKM termina en "F"
en lugar de "E"
Código en PTFE termina en "P"
en lugar de "E"
*PN6



DKOAM

d	Ref. EPDM	DN	PN	€ EPDM	€ FKM	€ PTFE
½"	DKOAM012E	15	10	213,11	290,24	323,05
¾"	DKOAM034E	20	10	228,95	309,95	340,88
1"	DKOAM100E	25	10	258,58	337,62	368,55
1¼"	DKOAM114E	32	10	314,60	445,80	482,28
1½"	DKOAM112E	40	10	383,03	514,16	550,68
2"	DKOAM200E	50	10	483,34	705,02	701,19
2½"	DKOAM212E	65	10	628,33	916,48	911,50

Válvula de membrana
DIALOCK®.
Con bridas ANSI 150 lbs.

Código en FKM termina en "F"
en lugar de "E"
Código en PTFE termina en "P"
en lugar de "E"



DKUIM

d	Ref. EPDM	DN	PN	€ EPDM	€ FKM	€ PTFE
20	DKUIM020E	15	10	163,90	241,05	273,74
25	DKUIM025E	20	10	175,44	256,42	287,24
32	DKUIM032E	25	10	204,41	283,47	314,20
40	DKUIM040E	32	10	237,27	368,35	404,94
50	DKUIM050E	40	10	303,80	431,96	468,43
63	DKUIM063E	50	10	372,07	593,84	589,97

Válvula de membrana
DIALOCK®.
Con enlaces H-H para soldar socket.

Código en FKM termina en "F"
en lugar de "E"
Código en PTFE termina en "P"
en lugar de "E"



INDUSTRIA

Sistema PP-H Socket

Válvulas anti-retorno



DKLUIM



d	Ref. EPDM	DN	PN	€ EPDM	€ FKM	€ PTFE
20	DKLUIM020E	15	10	305,69	379,80	411,21
25	DKLUIM025E	20	10	316,80	394,61	424,18
32	DKLUIM032E	25	10	344,63	420,58	450,11
40	DKLUIM040E	32	10	376,17	502,17	537,36
50	DKLUIM050E	40	10	Consultar	605,63	640,69
63	DKLUIM063E	50	10	548,09	761,22	757,50

Válvula de membrana
DIALOCK®. **CON LIMITADOR
DE CARRERA.**

Con enlaces H-H para soldar socket.

Código en FKM termina en "F"
en lugar de "E"
Código en PTFE termina en "P"
en lugar de "E"

CMDM
M-M fusión
socket.

CMUIM
H-H enlaces
socket.

CMIM
H-H fusión
socket.

CMFM
H-H roscar.



d-Rh	Ref. EPDM	DN	€ EPDM	€ FKM	€ PTFE
20	CMDM020E	15	162,03	171,54	185,18
16	CMIM016E	12	90,59	123,45	138,86
20	CMIM020E	15	90,59	123,45	138,86
20	CMUIM020E	15	144,54	175,44	192,80
¾"	CMFM038E	12	90,59	123,45	138,86
½"	CMFM012E	15	90,59	123,45	138,86

Válvula de membrana
compacta.

Código en FKM termina en "F"
en lugar de "E"
Código en PTFE termina en "P"
en lugar de "E"

VRUIM



d	Ref. EPDM	DN	PN	€ EPDM	€ FKM
20	VRUIM020E	15	10	78,47	84,88
25	VRUIM025E	20	10	88,77	97,29
32	VRUIM032E	25	10	92,17	105,53
40	VRUIM040E	32	10	112,00	128,30
50	VRUIM050E	40	10	126,74	155,16
63	VRUIM063E	50	10	193,69	235,79

Válvula anti-retorno inclinada.
Juntas en EPDM o FKM.

H-H con enlaces para fusión socket

Código en FKM termina en "F"
en lugar de "E"

VRUFM



Rh	Ref. EPDM	DN	PN	Pack	€ FKM
½"	VRUFM012F	15	10	2	90,00
¾"	VRUFM034F	20	10	2	103,08
1"	VRUFM100F	25	10	2	113,96
1¼"	VRUFM114F	32	10	2	135,99
1½"	VRUFM112F	40	10	2	164,51
2"	VRUFM200F	50	10	2	247,57

Válvula anti-retorno inclinada.
Juntas en FKM.

H-H con enlaces para roscar.

VRIM



d	Ref. EPDM	DN	PN	€ EPDM	€ FKM
75	VRIM075E	65	6	434,74	473,48
90	VRIM090E	80	4	710,04	779,44

Válvula anti-retorno inclinada.
Juntas en EPDM o FKM.

H-H para fusión socket
(sin enlaces en los extremos).

Código en FKM termina en "F"
en lugar de "E"



RVUIM

d	Ref. EPDM	DN	PN	€	
				EPDM	FKM
20	RVUIM020E	15	10	91,67	99,52
25	RVUIM025E	20	10	114,60	124,10
32	RVUIM032E	25	10	138,71	145,20
40	RVUIM040E	32	10	151,91	168,95
50	RVUIM050E	40	10	165,56	194,82
63	RVUIM063E	50	10	228,74	268,22

Filtro inclinado.

Juntas en EPDM o FKM.

H-H con enlaces para fusión socket.

Código en FKM termina en "F"
en lugar de "E"

RVUFM

Rh	Ref. EPDM	DN	PN	Pack	€	
					EPDM	FKM
½"	RVUFM012F	15	10	2	105,53	
¾"	RVUFM034F	20	10	2	131,60	
1"	RVUFM100F	25	10	2	156,85	
1¼"	RVUFM114F	32	10	2	179,07	
1½"	RVUFM112F	40	10	2	206,53	
2"	RVUFM200F	50	10	2	281,61	

Filtro inclinado.

Juntas en FKM.

H-H con enlaces para rosacar.



RVIM

d	Ref. EPDM	DN	PN	€	
				EPDM	FKM
75	RVIM075E	65	6	292,84	298,92
90	RVIM090E	80	4	362,34	383,63
110	RVIM110E	100	4	663,35	755,28

Filtro inclinado.

Juntas en EPDM o FKM.

H-H para fusión socket
(sin enlaces en los extremos).Código en FKM termina en "F"
en lugar de "E"

SRIM

d	Ref. EPDM	DN	PN	Pack	€	
					EPDM	FKM
20	SRIM020F	15	10	2	81,18	
25	SRIM025F	20	10	2	89,90	
32	SRIM032F	25	10	2	98,54	
40	SRIM040F	32	10	2	121,04	
50	SRIM050F	40	10	2	143,32	
63	SRIM063F	50	10	2	215,17	

Válvula de bola anti-retorno.

Juntas en FKM.

M-H para fusión socket.



FROM

d	Ref. EPDM	DN	PN	€ EPDM	€ FKM
40	FROM040E	32	6	374,87	607,01
50	FROM050E	40	6	374,87	615,15
63	FROM063E	50	6	397,50	652,21
75	FROM075E	65	6	487,75	809,43
90	FROM090E	80	6	532,06	906,98
110	FROM110E	100	6	653,78	1.087,60
140	FROM140E	125	6	869,88	1.364,97
160	FROM160E	150	6	899,64	1.476,87
225	FROM225E	200	6	1.131,94	1.746,96
280	FROM280E	250	6	1.731,62	2.564,51
315	FROM315E	300	6	2.429,06	3.418,96

Válvula anti-retorno de clapeta sin resorte.

ISO/DIN

Código en FKM termina en "F" en lugar de "E"



FROM

d	Ref. EPDM	DN	PN	€ EPDM	€ FKM
1¼"	FROM040EMLX	32	6	500,61	732,78
1½"	FROM050EMLX	40	6	500,61	740,91
2"	FROM063EMLX	50	6	531,24	786,02
2½"	FROM075EMLX	65	6	628,77	950,40
3"	FROM090EMLX	80	6	680,36	1.055,25
4"	FROM110EMLX	100	6	817,43	1.251,21
5"	FROM140EMLX	125	6	1.033,51	1.528,52
6"	FROM160EMLX	150	6	1.110,63	1.687,93
8"	FROM225EMLX	200	6	1.372,75	1.987,80
10"	FROM280EMLX	250	6	2.019,49	2.852,36
12"	FROM315EMLX	300	6	2.761,21	3.751,13

Válvula anti-retorno de clapeta con resorte inox.

ISO/DIN

Código en FKM termina en "F" en lugar de "E"



FROAM

d	Ref. EPDM	DN	PN	€ EPDM	€ FKM
1¼"	FROAM114E	32	6	460,70	692,85
1½"	FROAM112E	40	6	439,78	688,12
2"	FROAM200E	50	6	477,42	732,20
2½"	FROAM212E	65	6	579,50	901,15
3"	FROAM300E	80	6	638,94	1.013,81
4"	FROAM400E	100	6	775,44	1.217,22
5"	FROAM500E	125	6	1.032,70	1.527,71
6"	FROAM600E	150	6	1.060,34	1.637,55
8"	FROAM800E	200	6	1.375,93	1.991,04
10"	FROAM810E	250	6	2.045,92	2.878,66
12"	FROAM812E	300	6	2.951,40	3.941,42

Válvula anti-retorno de clapeta sin resorte.

ANSI 150 lbs.

Código en FKM termina en "F" en lugar de "E"



FROAM

d	Ref. EPDM	DN	PN	€ EPDM	€ FKM
1¼"	FROAM114EMLX	32	6	586,44	818,58
1½"	FROAM112EMLX	40	6	565,52	813,83
2"	FROAM200EMLX	50	6	611,18	865,94
2½"	FROAM212EMLX	65	6	720,53	1.042,17
3"	FROAM300EMLX	80	6	787,26	1.162,08
4"	FROAM400EMLX	100	6	939,04	1.380,81
5"	FROAM500EMLX	125	6	1.196,33	1.691,31
6"	FROAM600EMLX	150	6	1.271,34	1.848,53
8"	FROAM800EMLX	200	6	1.616,81	2.231,93
10"	FROAM810EMLX	250	6	2.333,74	3.166,51
12"	FROAM812EMLX	300	6	3.283,59	4.273,57

Válvula anti-retorno de clapeta con resorte inox.

ANSI 150 lbs.

Código en FKM termina en "F" en lugar de "E"



INDUSTRIA

Sistema PP-H Socket

Válvulas de bola actuadas



VKDIM/CE

soldar.

VKDFM/CE

roscar.

ACTUACIÓN ELÉCTRICA

ACTUACIÓN ELÉCTRICA CON BLOQUE DE SEGURIDAD

d-Rh	24-240 V AC/DC		24-240 V AC/DC		24-240 V AC/DC		24-240 V AC/DC	
	Ref.	€ EPDM	Ref.	€ FKM	Ref.	€ EPDM	Ref.	€ FKM
16	VKME016E2D	655,29	VKME016F2D	670,07	VKME016E2BD	1.209,94	VKME016F2BD	1.224,72
20	VKME020E2D	655,44	VKME020F2D	670,17	VKME020E2BD	1.210,10	VKME020F2BD	1.224,82
25	VKME025E2D	671,20	VKME025F2D	686,73	VKME025E2BD	1.225,89	VKME025F2BD	1.241,39
32	VKME032E2D	690,95	VKME032F2D	714,15	VKME032E2BD	1.245,63	VKME032F2BD	1.268,84
40	VKME040E2D	723,04	VKME040F2D	749,00	VKME040E2BD	1.277,72	VKME040F2BD	1.303,67
50	VKME050E2D	760,94	VKME050F2D	790,86	VKME050E2BD	1.315,65	VKME050F2BD	1.345,54
63	VKME063E2D	805,67	VKME063F2D	860,67	VKME063E2BD	1.360,35	VKME063F2BD	1.415,35
75	VKME075E2D	1.296,15	VKME075F2D	1.426,53	VKME075E2BD	1.850,84	VKME075F2BD	1.981,15
90	VKME090E2D	1.424,59	VKME090F2D	1.588,47	VKME090E2BD	1.979,28	VKME090F2BD	2.143,15
110	VKME110E2D	1.934,55	VKME110F2D	2.098,32	VKME110E2BD	2.489,20	VKME110F2BD	2.653,00
3/8"	VKME038E2D	668,35	VKME038F2D	683,87	VKME038E2BD	1.222,97	VKME038F2BD	1.238,52
1/2"	VKME012E2D	668,35	VKME012F2D	683,87	VKME012E2BD	1.222,97	VKME012F2BD	1.238,52
3/4"	VKME034E2D	681,50	VKME034F2D	697,91	VKME034E2BD	1.236,19	VKME034F2BD	1.252,58
1"	VKME100E2D	721,10	VKME100F2D	738,23	VKME100E2BD	1.275,79	VKME100F2BD	1.292,91
1 1/4"	VKME114E2D	736,81	VKME114F2D	766,01	VKME114E2BD	1.291,44	VKME114F2BD	1.320,70
1 1/2"	VKME112E2D	778,04	VKME112F2D	809,07	VKME112E2BD	1.332,75	VKME112F2BD	1.363,70
2"	VKME200E2D	833,20	VKME200F2D	889,92	VKME200E2BD	1.387,87	VKME200F2BD	1.444,61

Válvula de bola motorizada en PP-H 2 vías DUAL BLOCK®. Actuación eléctrica.

Disponemos de otras conexiones bajo pedido: bridas, soldar macho y roscar (NPT) Bajo pedido podemos suministrar otros actuadores: VALPES, BELIMO... Bajo pedido también disponibles en 12 V AC/DC

VKRIM/CE

soldar.

VKRFM/CE

roscar.

ACTUACIÓN ELÉCTRICA 24-240 V AC/DC CON POSICIONADOR 4-20 mA

d	Ref.	€ EPDM	Ref.	€ FKM	Ref.	€ EPDM	Ref.	€ FKM	Rh
16	VRME016E2PD	1.339,24	VRME016F2PD	1.354,02	VRME038E2PD	1.352,29	VRME038F2PD	1.367,87	3/8"
20	VRME020E2PD	1.339,44	VRME020F2PD	1.354,14	VRME012E2PD	1.352,29	VRME012F2PD	1.367,87	1/2"
25	VRME025E2PD	1.373,79	VRME025F2PD	1.389,40	VRME034E2PD	1.384,11	VRME034F2PD	1.400,49	3/4"
32	VRME032E2PD	1.431,55	VRME032F2PD	1.454,75	VRME100E2PD	1.461,62	VRME100F2PD	1.478,75	1"
40	VRME040E2PD	1.484,57	VRME040F2PD	1.510,47	VRME114E2PD	1.498,27	VRME114F2PD	1.527,57	1 1/4"
50	VRME050E2PD	1.587,36	VRME050F2PD	1.617,41	VRME112E2PD	1.604,43	VRME112F2PD	1.635,43	1 1/2"
63	VRME063E2PD	1.624,98	VRME063F2PD	1.680,03	VRME200E2PD	1.652,51	VRME200F2PD	1.709,29	2"

Válvula de bola REGULACIÓN motorizada en PP-H 2 vías DUAL BLOCK®. Actuación eléctrica con posicionador 4-20 mA.

Disponemos de otras conexiones bajo pedido: bridas, soldar macho y roscar (NPT) Bajo pedido podemos suministrar otros actuadores: VALPES, BELIMO... Bajo pedido también disponibles en 12 V AC/DC



VKDIM/CP

encolar.

VKDFM/CP

roscar.

ACTUACIÓN NEUMÁTICA ALUMINIO

ACTUACIÓN NEUMÁTICA ALUMINIO CON ELECTROVÁLVULA, FINALES DE CARRERA (ELECTROMECAÑICOS) Y REGULADORES DE ESCAPE



d-Rh	DOBLE EFECTO		SIMPLE EFECTO		DOBLE EFECTO		SIMPLE EFECTO	
	Ref.	€	Ref.	€	Ref.	€	Ref.	€
16	VKMP016EDED	317,89	VKMP016ESED	348,60	VKMP016EDEFD	518,55	VKMP016ESEFD	559,84
20	VKMP020EDED	318,06	VKMP020ESED	348,79	VKMP020EDEFD	518,71	VKMP020ESEFD	560,01
25	VKMP025EDED	333,85	VKMP025ESED	364,55	VKMP025EDEFD	534,45	VKMP025ESEFD	575,77
32	VKMP032EDED	353,60	VKMP032ESED	384,29	VKMP032EDEFD	554,22	VKMP032ESEFD	595,53
40	VKMP040EDED	385,68	VKMP040ESED	416,38	VKMP040EDEFD	586,28	VKMP040ESEFD	627,61
50	VKMP050EDED	423,59	VKMP050ESED	513,90	VKMP050EDEFD	624,21	VKMP050ESEFD	725,15
63	VKMP063EDED	468,29	VKMP063ESED	637,50	VKMP063EDEFD	668,91	VKMP063ESEFD	848,72
75	VKMP075EDED	797,46	VKMP075ESED	917,19	VKMP075EDEFD	998,07	VKMP075ESEFD	1.128,45
90	VKMP090EDED	925,90	VKMP090ESED	1.045,64	VKMP090EDEFD	1.126,51	VKMP090ESEFD	1.256,86
110	VKMP110EDED	1.085,16	VKMP110ESED	1.508,93	VKMP110EDEFD	1.285,80	VKMP110ESEFD	1.720,18
3/8"	VKMP038EDED	330,97	VKMP038ESED	361,66	VKMP038EDEFD	531,58	VKMP038ESEFD	572,89
1/2"	VKMP012EDED	330,97	VKMP012ESED	361,66	VKMP012EDEFD	531,58	VKMP012ESEFD	572,89
3/4"	VKMP034EDED	344,12	VKMP034ESED	374,82	VKMP034EDEFD	544,75	VKMP034ESEFD	586,07
1"	VKMP100EDED	383,73	VKMP100ESED	414,45	VKMP100EDEFD	584,35	VKMP100ESEFD	625,65
1 1/4"	VKMP114EDED	399,43	VKMP114ESED	430,13	VKMP114EDEFD	600,06	VKMP114ESEFD	641,36
1 1/2"	VKMP112EDED	440,66	VKMP112ESED	531,02	VKMP112EDEFD	641,31	VKMP112ESEFD	742,25
2"	VKMP200EDED	495,84	VKMP200ESED	665,07	VKMP200EDEFD	696,47	VKMP200ESEFD	876,30
16	VKMP016FDED	332,69	VKMP016FSED	363,41	VKMP016FDEFD	533,31	VKMP016FSEFD	574,64
20	VKMP020FDED	332,79	VKMP020FSED	363,49	VKMP020FDEFD	533,42	VKMP020FSEFD	574,72
25	VKMP025FDED	349,36	VKMP025FSED	380,07	VKMP025FDEFD	550,00	VKMP025FSEFD	591,30
32	VKMP032FDED	376,80	VKMP032FSED	407,52	VKMP032FDEFD	577,42	VKMP032FSEFD	618,72
40	VKMP040FDED	411,62	VKMP040FSED	442,31	VKMP040FDEFD	612,26	VKMP040FSEFD	653,57
50	VKMP050FDED	453,49	VKMP050FSED	543,82	VKMP050FDEFD	654,13	VKMP050FSEFD	755,07
63	VKMP063FDED	523,27	VKMP063FSED	692,52	VKMP063FDEFD	723,94	VKMP063FSEFD	903,75
75	VKMP075FDED	927,82	VKMP075FSED	1.047,54	VKMP075FDEFD	1.128,45	VKMP075FSEFD	1.258,76
90	VKMP090FDED	1.089,74	VKMP090FSED	1.209,48	VKMP090FDEFD	1.290,38	VKMP090FSEFD	1.420,73
110	VKMP110FDED	1.248,98	VKMP110FSED	1.672,75	VKMP110FDEFD	1.449,60	VKMP110FSEFD	1.883,95
3/8"	VKMP038FDED	346,49	VKMP038FSED	377,19	VKMP038FDEFD	547,12	VKMP038FSEFD	588,42
1/2"	VKMP012FDED	346,49	VKMP012FSED	377,19	VKMP012FDEFD	547,12	VKMP012FSEFD	588,42
3/4"	VKMP034FDED	360,55	VKMP034FSED	391,19	VKMP034FDEFD	561,14	VKMP034FSEFD	602,45
1"	VKMP100FDED	400,86	VKMP100FSED	431,57	VKMP100FDEFD	601,50	VKMP100FSEFD	642,80
1 1/4"	VKMP114FDED	428,63	VKMP114FSED	459,36	VKMP114FDEFD	629,28	VKMP114FSEFD	670,56
1 1/2"	VKMP112FDED	471,67	VKMP112FSED	562,02	VKMP112FDEFD	672,28	VKMP112FSEFD	773,22
2"	VKMP200FDED	552,54	VKMP200FSED	721,80	VKMP200FDEFD	753,19	VKMP200FSEFD	933,00

Válvula de bola motorizada

en PP-H 2 vías DUAL BLOCK®. Actuación neumática.

Disponemos de otras conexiones bajo pedido: bridas, soldar macho y roscar (NPT)

Las válvulas neumáticas se configuran NC (normalmente cerrada) de serie.

La configuración NA (normalmente abierta) se debe especificar en el pedido.

VKRIM/CP

soldar.

VKRFM/CP

roscar.

ACTUACIÓN NEUMÁTICA ALUMINIO DOBLE EFECTO
CON POSICIONADOR 4-20 mAACTUACIÓN NEUMÁTICA ALUMINIO SIMPLE EFECTO
CON POSICIONADOR 4-20 mA

d-Rh	Ref.	€ EPDM	Ref.	€ FKM	Ref.	€ EPDM	Ref.	€ FKM
16	VRMP016EDEPD	2.325,26	VRMP016FDEPD	2.340,04	VRMP016ESEPD	2.355,97	VRMP016FSEPD	2.370,75
20	VRMP020EDEPD	2.325,41	VRMP020FDEPD	2.340,16	VRMP020ESEPD	2.356,13	VRMP020FSEPD	2.370,83
25	VRMP025EDEPD	2.359,83	VRMP025FDEPD	2.375,37	VRMP025ESEPD	2.390,51	VRMP025FSEPD	2.406,08
32	VRMP032EDEPD	2.417,54	VRMP032FDEPD	2.440,74	VRMP032ESEPD	2.448,26	VRMP032FSEPD	2.471,46
40	VRMP040EDEPD	2.470,59	VRMP040FDEPD	2.496,49	VRMP040ESEPD	2.501,30	VRMP040FSEPD	2.527,21
50	VRMP050EDEPD	2.573,35	VRMP050FDEPD	2.603,38	VRMP050ESEPD	2.663,71	VRMP050FSEPD	2.693,74
63	VRMP063EDEPD	2.611,03	VRMP063FDEPD	2.666,00	VRMP063ESEPD	2.780,23	VRMP063FSEPD	2.835,26
3/8"	VRMP038EDEPD	2.338,31	VRMP038FDEPD	2.353,84	VRMP038ESEPD	2.369,03	VRMP038FSEPD	2.384,55
1/2"	VRMP012EDEPD	2.338,31	VRMP012FDEPD	2.353,84	VRMP012ESEPD	2.369,03	VRMP012FSEPD	2.384,55
3/4"	VRMP034EDEPD	2.370,11	VRMP034FDEPD	2.386,51	VRMP034ESEPD	2.400,81	VRMP034FSEPD	2.417,20
1"	VRMP100EDEPD	2.447,62	VRMP100FDEPD	2.464,77	VRMP100ESEPD	2.478,33	VRMP100FSEPD	2.495,46
1 1/4"	VRMP114EDEPD	2.484,29	VRMP114FDEPD	2.513,56	VRMP114ESEPD	2.515,00	VRMP114FSEPD	2.544,23
1 1/2"	VRMP112EDEPD	2.590,45	VRMP112FDEPD	2.621,43	VRMP112ESEPD	2.680,78	VRMP112FSEPD	2.711,78
2"	VRMP200EDEPD	2.638,50	VRMP200FDEPD	2.695,30	VRMP200ESEPD	2.807,76	VRMP200FSEPD	2.864,51

Válvula de bola **REGULACIÓN** motorizada
en PP-H 2 vías DUAL BLOCK®.

Actuación neumática con posicionador 4-20 mA.

Disponemos de otras conexiones bajo pedido: bridas, soldar macho y roscar (NPT)

Las válvulas neumáticas se configuran NC (normalmente cerrada) de serie.
La configuración NA (normalmente abierta) se debe especificar en el pedido.

VKRIM/CP

soldar.

VKRFM/CP

roscar.

ACTUACIÓN NEUMÁTICA POLIAMIDA DOBLE EFECTO
CON POSICIONADOR 4-20 mAACTUACIÓN NEUMÁTICA POLIAMIDA SIMPLE EFECTO
CON POSICIONADOR 4-20 mA

d-Rh	Ref.	€ EPDM	Ref.	€ FKM	Ref.	€ EPDM	Ref.	€ FKM
16	VRMP016EDEPP	1.885,55	VRMP016FDEPP	1.900,35	VRMP016ESEPP	1.908,69	VRMP016FSEPP	1.923,50
20	VRMP020EDEPP	1.885,72	VRMP020FDEPP	1.900,45	VRMP020ESEPP	1.908,85	VRMP020FSEPP	1.923,61
25	VRMP025EDEPP	1.920,11	VRMP025FDEPP	1.935,66	VRMP025ESEPP	1.943,23	VRMP025FSEPP	1.958,83
32	VRMP032EDEPP	1.977,84	VRMP032FDEPP	2.001,03	VRMP032ESEPP	2.105,09	VRMP032FSEPP	2.128,29
40	VRMP040EDEPP	2.030,90	VRMP040FDEPP	2.056,81	VRMP040ESEPP	2.158,14	VRMP040FSEPP	2.184,01
50	VRMP050EDEPP	2.133,65	VRMP050FDEPP	2.163,70	VRMP050ESEPP	2.382,39	VRMP050FSEPP	2.412,39
63	VRMP063EDEPP	2.375,37	VRMP063FDEPP	2.430,39	VRMP063ESEPP	2.441,90	VRMP063FSEPP	2.496,91
3/8"	VRMP038EDEPP	1.898,63	VRMP038FDEPP	1.914,15	VRMP038ESEPP	1.921,77	VRMP038FSEPP	1.937,31
1/2"	VRMP012EDEPP	1.898,63	VRMP012FDEPP	1.898,63	VRMP012ESEPP	1.921,77	VRMP012FSEPP	1.937,31
3/4"	VRMP034EDEPP	1.930,43	VRMP034FDEPP	1.946,78	VRMP034ESEPP	1.953,58	VRMP034FSEPP	1.969,96
1"	VRMP100EDEPP	2.007,91	VRMP100FDEPP	2.025,06	VRMP100ESEPP	2.135,17	VRMP100FSEPP	2.152,29
1 1/4"	VRMP114EDEPP	2.044,58	VRMP114FDEPP	2.073,88	VRMP114ESEPP	2.171,81	VRMP114FSEPP	2.201,11
1 1/2"	VRMP112EDEPP	2.150,74	VRMP112FDEPP	2.181,75	VRMP112ESEPP	2.399,44	VRMP112FSEPP	2.430,44
2"	VRMP200EDEPP	2.402,89	VRMP200FDEPP	2.459,64	VRMP200ESEPP	2.469,37	VRMP200FSEPP	2.526,16

Válvula de bola **REGULACIÓN** motorizada
en PP-H 2 vías DUAL BLOCK®.

Actuación neumática con posicionador 4-20 mA.

Disponemos de otras conexiones bajo pedido: bridas, soldar macho y roscar (NPT)

Las válvulas neumáticas se configuran NC (normalmente cerrada) de serie.
La configuración NA (normalmente abierta) se debe especificar en el pedido.



VKDIM/CP

soldar.

VKDFM/CP

roscar.

ACTUACIÓN NEUMÁTICA POLIAMIDA

ACTUACIÓN NEUMÁTICA POLIAMIDA CON ELECTROVÁLVULA, FINALES DE CARRERA (ELECTROMECÁNICOS) Y REGULADORES DE ESCAPE

d-Rh	DOBLE EFECTO		SIMPLE EFECTO		DOBLE EFECTO		SIMPLE EFECTO	
	Ref.	€	Ref.	€	Ref.	€	Ref.	€
16	VKMP016EDEP	336,63	VKMP016ESEP	359,78	VKMP016EDEFP	599,08	VKMP016ESEFP	622,22
20	VKMP020EDEP	336,81	VKMP020ESEP	359,93	VKMP020EDEFP	599,25	VKMP020ESEFP	622,38
25	VKMP025EDEP	352,55	VKMP025ESEP	375,69	VKMP025EDEFP	614,99	VKMP025ESEFP	638,14
32	VKMP032EDEP	372,35	VKMP032ESEP	499,58	VKMP032EDEFP	634,77	VKMP032ESEFP	762,02
40	VKMP040EDEP	404,41	VKMP040ESEP	531,67	VKMP040EDEFP	666,82	VKMP040ESEFP	794,11
50	VKMP050EDEP	442,31	VKMP050ESEP	691,03	VKMP050EDEFP	704,78	VKMP050ESEFP	953,47
63	VKMP063EDEP	691,08	VKMP063ESEP	757,60	VKMP063EDEFP	953,52	VKMP063ESEFP	1.020,01
75	VKMP075EDEP	926,49	VKMP075ESEP	1.175,64	VKMP075EDEFP	1.188,91	VKMP075ESEFP	1.438,07
90	VKMP090EDEP	1.054,93	VKMP090ESEP	1.304,06	VKMP090EDEFP	1.317,37	VKMP090ESEFP	1.566,53
110	VKMP110EDEP	1.180,82	VKMP110ESEP	1.451,20	VKMP110EDEFP	1.443,24	VKMP110ESEFP	1.713,64

3/8"	VKMP038EDEP	349,69	VKMP038ESEP	372,84	VKMP038EDEFP	612,16	VKMP038ESEFP	635,30
1/2"	VKMP012EDEP	349,69	VKMP012ESEP	372,84	VKMP012EDEFP	612,16	VKMP012ESEFP	635,30
3/4"	VKMP034EDEP	362,90	VKMP034ESEP	386,02	VKMP034EDEFP	625,31	VKMP034ESEFP	648,47
1"	VKMP100EDEP	402,45	VKMP100ESEP	529,71	VKMP100EDEFP	664,90	VKMP100ESEFP	792,15
1 1/4"	VKMP114EDEP	418,18	VKMP114ESEP	545,42	VKMP114EDEFP	680,62	VKMP114ESEFP	807,83
1 1/2"	VKMP112EDEP	459,41	VKMP112ESEP	708,10	VKMP112EDEFP	721,85	VKMP112ESEFP	970,55
2"	VKMP200EDEP	718,63	VKMP200ESEP	785,15	VKMP200EDEFP	981,08	VKMP200ESEFP	1.047,59

16	VKMP016FDEP	351,42	VKMP016FSEP	374,56	VKMP016FDEFP	613,86	VKMP016FSEFP	637,00
20	VKMP020FDEP	351,54	VKMP020FSEP	374,66	VKMP020FDEFP	613,98	VKMP020FSEFP	637,14
25	VKMP025FDEP	368,10	VKMP025FSEP	391,19	VKMP025FDEFP	630,55	VKMP025FSEFP	653,67
32	VKMP032FDEP	395,55	VKMP032FSEP	522,76	VKMP032FDEFP	657,96	VKMP032FSEFP	785,22
40	VKMP040FDEP	430,36	VKMP040FSEP	557,59	VKMP040FDEFP	692,81	VKMP040FSEFP	820,01
50	VKMP050FDEP	472,23	VKMP050FSEP	720,93	VKMP050FDEFP	734,68	VKMP050FSEFP	983,37
63	VKMP063FDEP	746,11	VKMP063FSEP	812,60	VKMP063FDEFP	1.008,50	VKMP063FSEFP	1.075,04
75	VKMP075FDEP	1.056,81	VKMP075FSEP	1.305,94	VKMP075FDEFP	1.319,25	VKMP075FSEFP	1.568,38
90	VKMP090FDEP	1.218,78	VKMP090FSEP	1.467,94	VKMP090FDEFP	1.481,24	VKMP090FSEFP	1.730,35
110	VKMP110FDEP	1.344,56	VKMP110FSEP	1.614,99	VKMP110FDEFP	1.607,01	VKMP110FSEFP	1.877,43

3/8"	VKMP038FDEP	365,24	VKMP038FSEP	388,36	VKMP038FDEFP	627,66	VKMP038FSEFP	650,81
1/2"	VKMP012FDEP	349,69	VKMP012FSEP	388,36	VKMP012FDEFP	612,16	VKMP012FSEFP	650,81
3/4"	VKMP034FDEP	379,25	VKMP034FSEP	402,37	VKMP034FDEFP	641,72	VKMP034FSEFP	664,84
1"	VKMP100FDEP	419,60	VKMP100FSEP	546,83	VKMP100FDEFP	682,05	VKMP100FSEFP	809,27
1 1/4"	VKMP114FDEP	447,36	VKMP114FSEP	574,64	VKMP114FDEFP	709,82	VKMP114FSEFP	837,06
1 1/2"	VKMP112FDEP	490,38	VKMP112FSEP	739,08	VKMP112FDEFP	752,83	VKMP112FSEFP	1.001,52
2"	VKMP200FDEP	775,33	VKMP200FSEP	841,87	VKMP200FDEFP	1.037,81	VKMP200FSEFP	1.104,31

Válvula de bola motorizada

en PP-H 2 vías DUAL BLOCK®. Actuación neumática.

Disponemos de otras conexiones bajo pedido: bridas, soldar macho y roscar (NPT)

Las válvulas neumáticas se configuran NC (normalmente cerrada) de serie. La configuración NA (normalmente abierta) se debe especificar en el pedido.



INDUSTRIA

Sistema PP-H Socket

Válvulas de 3 vías actuadas



LKDIM/CE
soldar.

LKDFM/CE
rosacar.

ACTUACIÓN ELÉCTRICA

ACTUACIÓN ELÉCTRICA CON BLOQUE DE SEGURIDAD

d-Rh	24-240 V AC/DC		24-240 V AC/DC		24-240 V AC/DC		24-240 V AC/DC	
	Ref.	€	Ref.	€	Ref.	€	Ref.	€
20	LKME020E2D	733,70	LKME020F2D	750,30	LKME020E2BD	1.288,38	LKME020F2BD	1.304,99
25	LKME025E2D	755,54	LKME025F2D	777,08	LKME025E2BD	1.310,19	LKME025F2BD	1.331,74
32	LKME032E2D	803,19	LKME032F2D	830,88	LKME032E2BD	1.357,88	LKME032F2BD	1.385,54
40	LKME040E2D	841,82	LKME040F2D	879,70	LKME040E2BD	1.396,50	LKME040F2BD	1.434,36
50	LKME050E2D	889,77	LKME050F2D	951,98	LKME050E2BD	1.444,42	LKME050F2BD	1.506,63
63	LKME063E2D	971,50	LKME063F2D	1.050,22	LKME063E2BD	1.526,20	LKME063F2BD	1.604,87
1/2"	LKME012E2D	748,14	LKME012F2D	764,78	LKME012E2BD	1.302,83	LKME012F2BD	1.319,43
3/4"	LKME034E2D	772,04	LKME034F2D	793,56	LKME034E2BD	1.326,72	LKME034F2BD	1.348,25
1"	LKME100E2D	824,39	LKME100F2D	852,07	LKME100E2BD	1.379,07	LKME100F2BD	1.406,75
1 1/4"	LKME114E2D	866,57	LKME114F2D	904,49	LKME114E2BD	1.421,22	LKME114F2BD	1.459,15
1 1/2"	LKME112E2D	920,92	LKME112F2D	983,08	LKME112E2BD	1.475,61	LKME112F2BD	1.537,77
2"	LKME200E2D	1.010,87	LKME200F2D	1.089,53	LKME200E2BD	1.565,53	LKME200F2BD	1.644,19

Válvula de bola motorizada en PP-H 3 vías DUAL BLOCK®.

Estándar paso en L, paso en T opcional, al mismo precio. Bajo pedido podemos suministrar otros actuadores: VALPES, BELIMO...

Disponemos de otras conexiones bajo pedido: bridas, soldar macho y rosacar (NPT).

Bajo pedido también disponibles en 12 V AC/DC

Actuación eléctrica.



LKDIM/CP

soldar.

LKDFM/CP

roscar.

ACTUACIÓN NEUMÁTICA ALUMINIO

ACTUACIÓN NEUMÁTICA ALUMINIO CON ELECTROVÁLVULA, FINALES DE CARRERA (ELECTROMECAÑICOS) Y REGULADORES DE ESCAPE

d-Rh	DOBLE EFECTO		SIMPLE EFECTO		DOBLE EFECTO		SIMPLE EFECTO	
	Ref.	€	Ref.	€	Ref.	€	Ref.	€
20	LKMP020EDED	396,34	LKMP020ESED	427,02	LKMP020EDEFD	596,97	LKMP020ESEFD	638,27
25	LKMP025EDED	418,18	LKMP025ESED	448,85	LKMP025EDEFD	618,77	LKMP025ESEFD	660,11
32	LKMP032EDED	465,85	LKMP032ESED	496,51	LKMP032EDEFD	666,44	LKMP032ESEFD	707,74
40	LKMP040EDED	504,44	LKMP040ESED	594,77	LKMP040EDEFD	705,09	LKMP040ESEFD	806,01
50	LKMP050EDED	588,13	LKMP050ESED	721,60	LKMP050EDEFD	788,77	LKMP050ESEFD	932,85
63	LKMP063EDED	669,89	LKMP063ESED	803,38	LKMP063EDEFD	870,50	LKMP063ESEFD	1.014,60

1/2"	LKMP012EDED	410,76	LKMP012ESED	441,49	LKMP012EDEFD	611,41	LKMP012ESEFD	652,71
3/4"	LKMP034EDED	434,66	LKMP034ESED	465,38	LKMP034EDEFD	635,30	LKMP034ESEFD	676,59
1"	LKMP100EDED	487,01	LKMP100ESED	517,73	LKMP100EDEFD	687,63	LKMP100ESEFD	728,96
1 1/4"	LKMP114EDED	529,19	LKMP114ESED	619,52	LKMP114EDEFD	729,81	LKMP114ESEFD	830,75
1 1/2"	LKMP112EDED	619,29	LKMP112ESED	752,78	LKMP112EDEFD	819,91	LKMP112ESEFD	964,01
2"	LKMP200EDED	709,24	LKMP200ESED	842,73	LKMP200EDEFD	909,85	LKMP200ESEFD	1.053,95

20	LKMP020FDED	412,93	LKMP020FSED	443,65	LKMP020FDEFD	613,57	LKMP020FSEFD	654,90
25	LKMP025FDED	439,71	LKMP025FSED	470,40	LKMP025FDEFD	640,35	LKMP025FSEFD	681,63
32	LKMP032FDED	493,47	LKMP032FSED	524,20	LKMP032FDEFD	694,12	LKMP032FSEFD	735,42
40	LKMP040FDED	542,33	LKMP040FSED	632,66	LKMP040FDEFD	742,94	LKMP040FSEFD	843,88
50	LKMP050FDED	650,37	LKMP050FSED	783,83	LKMP050FDEFD	850,99	LKMP050FSEFD	995,06
63	LKMP063FDED	748,58	LKMP063FSED	882,07	LKMP063FDEFD	949,23	LKMP063FSEFD	1.093,29

1/2"	LKMP012FDED	427,38	LKMP012FSED	458,09	LKMP012FDEFD	628,02	LKMP012FSEFD	669,29
3/4"	LKMP034FDED	456,19	LKMP034FSED	486,91	LKMP034FDEFD	656,81	LKMP034FSEFD	698,13
1"	LKMP100FDED	514,67	LKMP100FSED	545,42	LKMP100FDEFD	715,31	LKMP100FSEFD	756,62
1 1/4"	LKMP114FDED	567,12	LKMP114FSED	657,45	LKMP114FDEFD	767,74	LKMP114FSEFD	868,68
1 1/2"	LKMP112FDED	681,48	LKMP112FSED	814,94	LKMP112FDEFD	882,07	LKMP112FSEFD	1.026,17
2"	LKMP200FDED	787,90	LKMP200FSED	921,39	LKMP200FDEFD	988,54	LKMP200FSEFD	1.132,59

Válvula de bola motorizada en PP-H 3 vías DUAL BLOCK®. Actuación neumática.

Estándar paso en L, paso en T opcional al mismo precio. Disponemos de otras conexiones bajo pedido: bridas, soldar macho y roscar (NPT). Las válvulas neumáticas se configuran NC (normalmente cerrada) de serie. La configuración NA (normalmente abierta) se debe especificar en el pedido.

LKDIM/CP

soldar.

LKDFM/CP

roscar.

ACTUACIÓN NEUMÁTICA POLIAMIDA

ACTUACIÓN NEUMÁTICA POLIAMIDA CON ELECTROVÁLVULA, FINALES DE CARRERA (ELECTROMECAÑICOS) Y REGULADORES DE ESCAPE



d-Rh	DOBLE EFECTO		SIMPLE EFECTO		DOBLE EFECTO		SIMPLE EFECTO	
	Ref.	€	Ref.	€	Ref.	€	Ref.	€
20	LKMP020EDEP	454,49	LKMP020ESEP	477,64	LKMP020EDEF	716,91	LKMP020ESEFP	740,06
25	LKMP025EDEP	521,52	LKMP025ESEP	544,64	LKMP025EDEF	783,96	LKMP025ESEFP	807,09
32	LKMP032EDEP	569,18	LKMP032ESEP	696,38	LKMP032EDEF	831,62	LKMP032ESEFP	958,83
40	LKMP040EDEP	622,67	LKMP040ESEP	871,38	LKMP040EDEF	885,13	LKMP040ESEFP	1.133,80
50	LKMP050EDEP	763,62	LKMP050ESEP	916,83	LKMP050EDEF	1.026,07	LKMP050ESEFP	1.179,30
63	LKMP063EDEP	921,52	LKMP063ESEP	988,03	LKMP063EDEF	1.183,93	LKMP063ESEFP	1.250,47

1/2"	LKMP012EDEP	468,91	LKMP012ESEP	492,06	LKMP012EDEF	731,35	LKMP012ESEFP	754,51
3/4"	LKMP034EDEP	538,02	LKMP034ESEP	561,14	LKMP034EDEF	800,46	LKMP034ESEFP	823,59
1"	LKMP100EDEP	590,38	LKMP100ESEP	717,63	LKMP100EDEF	852,82	LKMP100ESEFP	980,05
1 1/4"	LKMP114EDEP	647,44	LKMP114ESEP	896,10	LKMP114EDEF	909,85	LKMP114ESEFP	1.158,57
1 1/2"	LKMP112EDEP	794,78	LKMP112ESEP	948,01	LKMP112EDEF	1.057,22	LKMP112ESEFP	1.210,46
2"	LKMP200EDEP	960,84	LKMP200ESEP	1.027,40	LKMP200EDEF	1.223,31	LKMP200ESEFP	1.289,82

20	LKMP020FDEP	471,07	LKMP020FSEP	494,22	LKMP020FDEF	733,55	LKMP020FSEFP	756,69
25	LKMP025FDEP	543,05	LKMP025FSEP	566,17	LKMP025FDEF	805,49	LKMP025FSEFP	828,64
32	LKMP032FDEP	596,83	LKMP032FSEP	724,09	LKMP032FDEF	859,28	LKMP032FSEFP	986,53
40	LKMP040FDEP	660,54	LKMP040FSEP	909,26	LKMP040FDEF	922,98	LKMP040FSEFP	1.171,68
50	LKMP050FDEP	825,83	LKMP050FSEP	979,07	LKMP050FDEF	1.088,28	LKMP050FSEFP	1.241,51
63	LKMP063FDEP	1.000,21	LKMP063FSEP	1.066,72	LKMP063FDEF	1.262,66	LKMP063FSEFP	1.329,16

1/2"	LKMP012FDEP	485,54	LKMP012FSEP	508,67	LKMP012FDEF	747,99	LKMP012FSEFP	771,14
3/4"	LKMP034FDEP	559,55	LKMP034FSEP	582,67	LKMP034FDEF	821,99	LKMP034FSEFP	845,12
1"	LKMP100FDEP	618,03	LKMP100FSEP	745,29	LKMP100FDEF	880,47	LKMP100FSEFP	1.007,73
1 1/4"	LKMP114FDEP	685,36	LKMP114FSEP	934,06	LKMP114FDEF	947,81	LKMP114FSEFP	1.196,48
1 1/2"	LKMP112FDEP	856,94	LKMP112FSEP	1.010,17	LKMP112FDEF	1.119,38	LKMP112FSEFP	1.272,62
2"	LKMP200FDEP	1.039,51	LKMP200FSEP	1.106,04	LKMP200FDEF	1.301,95	LKMP200FSEFP	1.368,46

Válvula de bola motorizada en PP-H 3 vías DUAL BLOCK®. Actuación neumática.

Estándar paso en L, paso en T opcional, al mismo precio. Disponemos de otras conexiones bajo pedido: bridas, soldar macho y roscar (NPT). Las válvulas neumáticas se configuran NC (normalmente cerrada) de serie. La configuración NA (normalmente abierta) se debe especificar en el pedido.



INDUSTRIA

Sistema PP-H Socket

Válvulas de mariposa actuadas



FKOM/CE

ACTUACIÓN ELÉCTRICA**ACTUACIÓN ELÉCTRICA CON BLOQUE DE SEGURIDAD**

d	24-240 V AC/DC		24-240 V AC/DC		24-240 V AC/DC		24-240 V AC/DC	
	Ref.	€ EPDM	Ref.	€ FKM	Ref.	€ EPDM	Ref.	€ FKM
50	FKME050E2D	874,57	FKME050F2D	1.039,99	FKME050E2BD	1.429,26	FKME050F2BD	1.594,63
63	FKME063E2D	893,78	FKME063F2D	1.068,91	FKME063E2BD	1.448,44	FKME063F2BD	1.623,57
75	FKME075E2D	1.191,71	FKME075F2D	1.386,28	FKME075E2BD	1.746,42	FKME075F2BD	1.940,96
90	FKME090E2D	1.225,13	FKME090F2D	1.428,43	FKME090E2BD	1.779,79	FKME090F2BD	1.983,14
110	FKME110E2D	1.261,44	FKME110F2D	1.471,95	FKME110E2BD	1.816,13	FKME110F2BD	2.026,61
125	FKME140E2D	1.775,41	FKME140F2D	2.062,83	FKME140E2BD	2.330,07	FKME140F2BD	2.617,57
140	FKME140E2D	1.775,41	FKME140F2D	2.062,83	FKME140E2BD	2.330,07	FKME140F2BD	2.617,57
160	FKME160E2D	2.079,70	FKME160F2D	2.370,16	FKME160E2BD	2.728,78	FKME160F2BD	3.019,27
200	FKME225E2D	2.419,62	FKME225F2D	2.798,56	FKME225E2BD	3.068,68	FKME225F2BD	3.447,67
225	FKME225E2D	2.419,62	FKME225F2D	2.798,56	FKME225E2BD	3.068,68	FKME225F2BD	3.447,67
250	FKME280E2D	4.373,41	FKME280F2D	6.066,58	FKME280E2BD	5.022,49	FKME280F2BD	6.715,65
280	FKME280E2D	4.373,41	FKME280F2D	6.066,58	FKME280E2BD	5.022,49	FKME280F2BD	6.715,65
315	FKME315E2D	4.621,69	FKME315F2D	6.467,42	FKME315E2BD	5.270,77	FKME315F2BD	7.116,51
355	FKME355E2D	11.072,32	FKME355F2D	15.002,86				
400	FKME400E2D	12.353,54	FKME400F2D	18.026,78				

Válvula de mariposa motorizada
cuerpo en PPGR y disco en PP-H.
Actuación eléctrica.

Bajo pedido podemos suministrar otros actuadores: VALPES, BELIMO...
Bajo pedido también disponibles en 12 V AC/DC



FKOM/CP

ACTUACIÓN NEUMÁTICA ALUMINIO

ACTUACIÓN NEUMÁTICA ALUMINIO CON ELECTROVÁLVULA, FINALES DE CARRERA (ELECTROMECAÑICOS) Y REGULADORES DE ESCAPE

d	DOBLE EFECTO		SIMPLE EFECTO		DOBLE EFECTO		SIMPLE EFECTO	
	Ref.	€	Ref.	€	Ref.	€	Ref.	€
50	FKMP050EDED	536,84	FKMP050ESED	627,22	FKMP050EDEFD	737,48	FKMP050ESEFD	838,45
63	FKMP063EDED	556,05	FKMP063ESED	646,41	FKMP063EDEFD	756,69	FKMP063ESEFD	857,61
75	FKMP075EDED	630,13	FKMP075ESED	763,62	FKMP075EDEFD	830,75	FKMP075ESEFD	974,82
90	FKMP090EDED	726,08	FKMP090ESED	845,82	FKMP090EDEFD	926,69	FKMP090ESEFD	1.057,04
110	FKMP110EDED	762,44	FKMP110ESED	1.213,16	FKMP110EDEFD	963,03	FKMP110ESEFD	1.424,39
125	FKMP140EDED	943,20	FKMP140ESED	1.620,60	FKMP140EDEFD	1.143,85	FKMP140ESEFD	1.831,83
140	FKMP140EDED	943,20	FKMP140ESED	1.620,60	FKMP140EDEFD	1.143,85	FKMP140ESEFD	1.831,83
160	FKMP160EDED	1.005,62	FKMP160ESED	1.682,97	FKMP160EDEFD	1.206,23	FKMP160ESEFD	1.894,20
200	FKMP225EDED	1.484,42	FKMP225ESED	2.414,11	FKMP225EDEFD	1.685,06	FKMP225ESEFD	2.625,32
225	FKMP225EDED	1.484,42	FKMP225ESED	2.414,11	FKMP225EDEFD	1.685,06	FKMP225ESEFD	2.625,32
250	FKMP280EDED	3.619,14	FKMP280ESED	5.590,10	FKMP280EDEFD	3.819,73	FKMP280ESEFD	5.801,35
280	FKMP280EDED	3.619,14	FKMP280ESED	5.590,10	FKMP280EDEFD	3.819,73	FKMP280ESEFD	5.801,35
315	FKMP315EDED	4.135,45	FKMP315ESED	6.856,59	FKMP315EDEFD	4.336,09	FKMP315ESEFD	7.067,84
355	FKMP355EDED	6.340,47	FKMP355ESED	8.391,08				
400	FKMP400EDED	7.085,09	FKMP400ESED	10.986,78				

50	FKMP050FDED	702,25	FKMP050FSED	792,59	FKMP050EDEFD	737,48	FKMP050FSEFD	1.003,82
63	FKMP063FDED	731,20	FKMP063FSED	821,56	FKMP063EDEFD	756,69	FKMP063FSEFD	1.032,76
75	FKMP075FDED	824,70	FKMP075FSED	958,16	FKMP075EDEFD	830,75	FKMP075FSEFD	1.169,36
90	FKMP090FDED	929,40	FKMP090FSED	1.049,14	FKMP090EDEFD	926,69	FKMP090FSEFD	1.260,39
110	FKMP110FDED	972,89	FKMP110FSED	1.423,61	FKMP110EDEFD	963,03	FKMP110FSEFD	1.634,85
125	FKMP140FDED	1.230,67	FKMP140FSED	1.908,08	FKMP140EDEFD	1.143,85	FKMP140FSEFD	2.119,31
140	FKMP140FDED	1.230,67	FKMP140FSED	1.908,08	FKMP140EDEFD	1.143,85	FKMP140FSEFD	2.119,31
160	FKMP160FDED	1.296,05	FKMP160FSED	1.973,43	FKMP160EDEFD	1.206,23	FKMP160FSEFD	2.184,68
200	FKMP225FDED	1.863,37	FKMP225FSED	2.793,08	FKMP225EDEFD	1.685,06	FKMP225FSEFD	3.004,28
225	FKMP225FDED	1.863,37	FKMP225FSED	2.793,08	FKMP225EDEFD	1.685,06	FKMP225FSEFD	3.004,28
250	FKMP280FDED	5.312,31	FKMP280FSED	7.283,28	FKMP280EDEFD	3.819,73	FKMP280FSEFD	7.494,52
280	FKMP280FDED	5.312,31	FKMP280FSED	7.283,28	FKMP280EDEFD	3.819,73	FKMP280FSEFD	7.494,52
315	FKMP315FDED	5.981,24	FKMP315FSED	8.702,32	FKMP315EDEFD	4.336,09	FKMP315FSEFD	8.913,57
355	FKMP355FDED	10.271,01	FKMP355FSED	12.321,61				
400	FKMP400FDED	12.758,33	FKMP400FSED	16.660,07				

Válvula de mariposa motorizada cuerpo en PPGR y disco en PP-H. Actuación neumática.

Las válvulas neumáticas se configuran NC (normalmente cerrada) de serie. La configuración NA (normalmente abierta) se debe especificar en el pedido.



FKOM/CP

ACTUACIÓN NEUMÁTICA POLIAMIDA

ACTUACIÓN NEUMÁTICA POLIAMIDA CON ELECTROVÁLVULA, FINALES DE CARRERA (ELECTROMECÁNICOS) Y REGULADORES DE ESCAPE

d	DOBLE EFECTO		SIMPLE EFECTO		DOBLE EFECTO		SIMPLE EFECTO	
	Ref.	€	Ref.	€	Ref.	€	Ref.	€
50	FKMP050EDEP	643,83	FKMP050ESEP	806,98	FKMP050EDEFP	906,25	FKMP050ESEFP	1.069,43
63	FKMP063EDEP	663,01	FKMP063ESEP	826,16	FKMP063EDEFP	925,46	FKMP063ESEFP	1.088,61
75	FKMP075EDEP	701,33	FKMP075ESEP	864,48	FKMP075EDEFP	963,77	FKMP075ESEFP	1.126,92
90	FKMP090EDEP	831,03	FKMP090ESEP	897,52	FKMP090EDEFP	1.093,48	FKMP090ESEFP	1.159,99
110	FKMP110EDEP	867,36	FKMP110ESEP	1.129,12	FKMP110EDEFP	1.129,81	FKMP110ESEFP	1.391,56
125	FKMP140EDEP	1.006,88	FKMP140ESEP	1.568,74	FKMP140EDEFP	1.269,32	FKMP140ESEFP	1.831,19
140	FKMP140EDEP	1.006,88	FKMP140ESEP	1.568,74	FKMP140EDEFP	1.269,32	FKMP140ESEFP	1.831,19
160	FKMP160EDEP	1.252,84	FKMP160ESEP	1.631,14	FKMP160EDEFP	1.515,28	FKMP160ESEFP	1.893,58
200	FKMP225EDEP	1.465,82	FKMP225ESEP	2.246,48	FKMP225EDEFP	1.728,27	FKMP225ESEFP	2.508,93
225	FKMP225EDEP	1.465,82	FKMP225ESEP	2.246,48	FKMP225EDEFP	1.728,27	FKMP225ESEFP	2.508,93
250*	FKMP280EDEP	3.797,82	FKMP280ESEP	5.471,34	FKMP280EDEFP	4.060,26	FKMP280ESEFP	5.733,78
280*	FKMP280EDEP	3.797,82	FKMP280ESEP	5.471,34	FKMP280EDEFP	4.060,26	FKMP280ESEFP	5.733,78
315*	FKMP315EDEP	4.046,10	FKMP315ESEP	5.719,64	FKMP315EDEFP	4.308,54	FKMP315ESEFP	5.982,09
355	FKMP355EDEP	Consultar	FKMP355ESEP	Consultar				
400	FKMP400EDEP	Consultar	FKMP400ESEP	Consultar				

50	FKMP050FDEP	809,22	FKMP050FSEP	972,37	FKMP050FDEFP	1.071,66	FKMP050FSEFP	1.234,82
63	FKMP063FDEP	838,14	FKMP063FSEP	1.001,29	FKMP063FDEFP	1.100,56	FKMP063FSEFP	1.263,76
75	FKMP075FDEP	895,89	FKMP075FSEP	1.059,05	FKMP075FDEFP	1.158,34	FKMP075FSEFP	1.321,49
90	FKMP090FDEP	1.034,36	FKMP090FSEP	1.100,86	FKMP090FDEFP	1.296,82	FKMP090FSEFP	1.363,31
110	FKMP110FDEP	1.077,84	FKMP110FSEP	1.339,60	FKMP110FDEFP	1.340,29	FKMP110FSEFP	1.602,04
125	FKMP140FDEP	1.294,33	FKMP140FSEP	1.856,19	FKMP140FDEFP	1.556,77	FKMP140FSEFP	2.118,66
140	FKMP140FDEP	1.294,33	FKMP140FSEP	1.856,19	FKMP140FDEFP	1.556,77	FKMP140FSEFP	2.118,66
160	FKMP160FDEP	1.543,33	FKMP160FSEP	1.921,60	FKMP160FDEFP	1.805,74	FKMP160FSEFP	2.184,01
200	FKMP225FDEP	1.844,78	FKMP225FSEP	2.625,45	FKMP225FDEFP	2.107,23	FKMP225FSEFP	2.887,89
225	FKMP225FDEP	1.844,78	FKMP225FSEP	2.625,45	FKMP225FDEFP	2.107,23	FKMP225FSEFP	2.887,89
250*	FKMP280FDEP	5.490,98	FKMP280FSEP	7.164,53	FKMP280FDEFP	5.753,43	FKMP280FSEFP	7.426,97
280*	FKMP280FDEP	5.490,98	FKMP280FSEP	7.164,53	FKMP280FDEFP	5.753,43	FKMP280FSEFP	7.426,97
315*	FKMP315FDEP	5.891,84	FKMP315FSEP	7.565,38	FKMP315FDEFP	6.154,28	FKMP315FSEFP	7.827,82
355	FKMP355FDEP	Consultar	FKMP355FSEP	Consultar				
400	FKMP400FDEP	Consultar	FKMP400FSEP	Consultar				

Válvula de mariposa motorizada
cuerpo en PPGR y disco en PP-H.
Actuación neumática.

Las válvulas neumáticas se configuran NC (normalmente cerrada) de serie.
La configuración NA (normalmente abierta) se debe especificar en el pedido
* Actuadores de aluminio.



Sistema PP-H Socket

Válvulas de membrana actuadas



DK/CP NC

d	Modelo	DN	Ref. EPDM	€ EPDM
20	DKDM/CP NC	15	DKDMNC020E	373,22
25	DKDM/CP NC	20	DKDMNC025E	395,31
32	DKDM/CP NC	25	DKDMNC032E	481,04
40	DKDM/CP NC	32	DKDMNC040E	634,15
50	DKDM/CP NC	40	DKDMNC050E	717,17
63	DKDM/CP NC	50	DKDMNC063E	995,32
75	VKDM/CP NC	65	VKDMNC075E	1.111,14
90	VMDM/CP NC	80	VMDMNC090E	1.806,91
110	VMDM/CP NC	100	VMDMNC110E	2.246,48



VM/CP NC

Ref. FKM	€ FKM	Ref. PTFE	€ PTFE
DKDMNC020F	432,14	DKDMNC020P	457,94
DKDMNC025F	455,47	DKDMNC025P	478,80
DKDMNC032F	553,24	DKDMNC032P	582,08
DKDMNC040F	751,13	DKDMNC040P	782,68
DKDMNC050F	848,51	DKDMNC050P	882,90
DKDMNC063F	1.245,87	DKDMNC063P	1.209,41
DKDMNC075F	1.495,08	DKDMNC075P	1.451,27
VMDMNC090F	2.383,16	VMDMNC090P	2.075,50
VMDMNC110F	2.798,72	VMDMNC110P	2.500,05

Válvula neumática **NORMALMENTE CERRADA**.
M-M para soldar socket.



DK/CP NO

d	Modelo	DN	Ref. EPDM	€ EPDM
20	DKDM/CP NO	15	DKDMNO020E	311,27
25	DKDM/CP NO	20	DKDMNO025E	333,39
32	DKDM/CP NO	25	DKDMNO032E	416,61
40	DKDM/CP NO	32	DKDMNO040E	441,49
50	DKDM/CP NO	40	DKDMNO050E	515,85
63	DKDM/CP NO	50	DKDMNO063E	660,93
75	DKDM/CP NO	65	DKDMNO075E	793,08
90	VMDM/CP NO	80	VMDMNO090E	1.253,08
110	VMDM/CP NO	100	VMDMNO110E	1.782,70



VM/CP NO

Ref. FKM	€ FKM	Ref. PTFE	€ PTFE
DKDMNO020F	370,23	DKDMNO020P	396,01
DKDMNO025F	393,56	DKDMNO025P	416,92
DKDMNO032F	524,92	DKDMNO032P	557,13
DKDMNO040F	597,89	DKDMNO040P	638,91
DKDMNO050F	685,14	DKDMNO050P	731,45
DKDMNO063F	943,02	DKDMNO063P	935,01
DKDMNO075F	1.131,64	DKDMNO075P	1.122,01
VMDMNO090F	1.925,28	VMDMNO090P	1.566,30
VMDMNO110F	2.509,42	VMDMNO110P	1.886,58

Válvula neumática **NORMALMENTE ABIERTA**.
M-M para soldar socket.



DK/CP DE

d	Modelo	DN	Ref. EPDM	€ EPDM
20	DKDM/CP DE	15	DKDMA020E	249,39
25	DKDM/CP DE	20	DKDMA025E	271,46
32	DKDM/CP DE	25	DKDMA032E	365,58
40	DKDM/CP DE	32	DKDMA040E	401,34
50	DKDM/CP DE	40	DKDMA050E	445,17
63	DKDM/CP DE	50	DKDMA063E	570,37
75	DKDM/CP DE	65	DKDMA075E	684,43
90	VMDM/CP DE	80	VMDMA090E	1.538,13
110	VMDM/CP DE	100	VMDMA110E	2.056,40



VM/CP DE

Ref. FKM	€ FKM	Ref. PTFE	€ PTFE
DKDMA020F	308,28	DKDMA020P	334,08
DKDMA025F	331,64	DKDMA025P	354,97
DKDMA032F	466,80	DKDMA032P	497,08
DKDMA040F	543,53	DKDMA040P	580,82
DKDMA050F	591,23	DKDMA050P	631,25
DKDMA063F	813,82	DKDMA063P	806,92
DKDMA075F	1.033,10	DKDMA075P	968,30
VMDMA090F	2.210,36	VMDMA090P	1.851,35
VMDMA110F	2.581,59	VMDMA110P	2.230,03

Válvula neumática **DOBLE EFECTO**.
M-M para soldar socket.

DK/CP NC

d	Modelo	DN	Ref. EPDM	€ EPDM	Ref. FKM	€ FKM	Ref. PTFE	€ PTFE
20	DKUIM/CP NC	15	DKUIMNC020E	390,40	DKUIMNC020F	450,60	DKUIMNC020P	476,41
25	DKUIM/CP NC	20	DKUIMNC025E	413,75	DKUIMNC025F	450,60	DKUIMNC025P	497,23
32	DKUIM/CP NC	25	DKUIMNC032E	504,11	DKUIMNC032F	576,34	DKUIMNC032P	605,26
40	DKUIM/CP NC	32	DKUIMNC040E	658,69	DKUIMNC040F	775,64	DKUIMNC040P	808,86
50	DKUIM/CP NC	40	DKUIMNC050E	743,76	DKUIMNC050F	875,04	DKUIMNC050P	909,42
63	DKUIM/CP NC	50	DKUIMNC063E	1.034,41	DKUIMNC063F	1.254,69	DKUIMNC063P	1.248,44

Válvula neumática **NORMALMENTE CERRADA**.
 Con enlaces H-H para soldar socket.

DK/CP NO

d	Modelo	DN	Ref. EPDM	€ EPDM	Ref. FKM	€ FKM	Ref. PTFE	€ PTFE
20	DKUIM/CP NO	15	DKUIMNO020E	328,50	DKUIMNO020F	388,67	DKUIMNO020P	414,47
25	DKUIM/CP NO	20	DKUIMNO025E	351,85	DKUIMNO025F	388,67	DKUIMNO025P	435,31
32	DKUIM/CP NO	25	DKUIMNO032E	441,69	DKUIMNO032F	538,31	DKUIMNO032P	491,72
40	DKUIM/CP NO	32	DKUIMNO040E	473,13	DKUIMNO040F	629,57	DKUIMNO040P	670,51
50	DKUIM/CP NO	40	DKUIMNO050E	550,07	DKUIMNO050F	719,40	DKUIMNO050P	765,68
63	DKUIM/CP NO	50	DKUIMNO063E	713,33	DKUIMNO063F	993,38	DKUIMNO063P	987,34

Válvula neumática **NORMALMENTE ABIERTA**.
 Con enlaces H-H para soldar socket.

DK/CP DE

d	Modelo	DN	Ref. EPDM	€ EPDM	Ref. FKM	€ FKM	Ref. PTFE	€ PTFE
20	DKUIM/CP DE	15	DKUIMDA020E	266,56	DKUIMDA020F	326,75	DKUIMDA020P	352,52
25	DKUIM/CP DE	20	DKUIMDA025E	289,92	DKUIMDA025F	326,75	DKUIMDA025P	373,41
32	DKUIM/CP DE	25	DKUIMDA032E	389,22	DKUIMDA032F	478,69	DKUIMDA032P	520,70
40	DKUIM/CP DE	32	DKUIMDA040E	430,13	DKUIMDA040F	572,32	DKUIMDA040P	609,55
50	DKUIM/CP DE	40	DKUIMDA050E	474,69	DKUIMDA050F	620,84	DKUIMDA050P	660,77
63	DKUIM/CP DE	50	DKUIMDA063E	615,58	DKUIMDA063F	857,29	DKUIMDA063P	852,07

Válvula neumática **DOBLE EFECTO**.
 Con enlaces H-H para soldar socket.



Sistema PP-H Socket

Válvulas de membrana actuadas



DK/CP NC



d	Modelo	DN	Ref. EPDM	€ EPDM
20	DKOM/CP NC	15	DKOMNC020E	429,20
25	DKOM/CP NC	20	DKOMNC025E	454,64
32	DKOM/CP NC	25	DKOMNC032E	553,11
40	DKOM/CP NC	32	DKOMNC040E	729,19
50	DKOM/CP NC	40	DKOMNC050E	824,75
63	DKOM/CP NC	50	DKOMNC063E	1.144,64
75	DKOM/CP NC	65	DKOMNC075E	1.373,61
90	VMOM/CP NC	80	VMOMNC090E	2.077,92
110	VMOM/CP NC	100	VMOMNC110E	2.583,45

VM/CP NC



Ref. FKM	€ FKM	Ref. PTFE	€ PTFE
DKOMNC020F	488,12	DKOMNC020P	513,92
DKOMNC025F	514,77	DKOMNC025P	538,10
DKOMNC032F	625,34	DKOMNC032P	621,06
DKOMNC040F	846,23	DKOMNC040P	650,23
DKOMNC050F	956,08	DKOMNC050P	990,43
DKOMNC063F	1.395,22	DKOMNC063P	1.358,72
DKOMNC075F	1.674,24	DKOMNC075P	1.630,47
VMOMNC090F	2.654,19	VMOMNC090P	2.346,58
VMOMNC110F	3.134,78	VMOMNC110P	2.836,70

Válvula neumática **NORMALMENTE CERRADA.**
Con bridas DIN.

Disponibles con bridas ANSI 150 libras al mismo precio

DK/CP NO



d	Modelo	DN	Ref. EPDM	€ EPDM
20	DKOM/CP NO	15	DKOMNO020E	367,25
25	DKOM/CP NO	20	DKOMNO025E	392,69
32	DKOM/CP NO	25	DKOMNO032E	498,60
40	DKOM/CP NO	32	DKOMNO040E	546,11
50	DKOM/CP NO	40	DKOMNO050E	634,17
63	DKOM/CP NO	50	DKOMNO063E	825,13
75	DKOM/CP NO	65	DKOMNO075E	990,14
90	VMOM/CP NO	80	VMOMNO090E	1.524,09
110	VMOM/CP NO	100	VMOMNO110E	2.029,15

VM/CP NO



Ref. FKM	€ FKM	Ref. PTFE	€ PTFE
DKOMNO020F	426,21	DKOMNO020P	451,99
DKOMNO025F	452,87	DKOMNO025P	476,17
DKOMNO032F	606,88	DKOMNO032P	541,30
DKOMNO040F	702,54	DKOMNO040P	743,54
DKOMNO050F	803,45	DKOMNO050P	849,78
DKOMNO063F	1.107,28	DKOMNO063P	1.099,27
DKOMNO075F	1.328,73	DKOMNO075P	1.319,10
VMOMNO090F	2.196,25	VMOMNO090P	1.837,31
VMOMNO110F	2.593,93	VMOMNO110P	2.221,04

Válvula neumática **NORMALMENTE ABIERTA.**
Con bridas DIN.

Disponibles con bridas ANSI 150 libras al mismo precio

DK/CP DE



d	Modelo	DN	Ref. EPDM	€ EPDM
20	DKOM/CP DE	15	DKOMDA020E	305,34
25	DKOM/CP DE	20	DKOMDA025E	330,76
32	DKOM/CP DE	25	DKOMDA032E	442,80
40	DKOM/CP DE	32	DKOMDA040E	496,49
50	DKOM/CP DE	40	DKOMDA050E	547,27
63	DKOM/CP DE	50	DKOMDA063E	712,07
75	DKOM/CP DE	65	DKOMDA075E	854,50
90	VMOM/CP DE	80	VMOMDA090E	1.809,17
110	VMOM/CP DE	100	VMOMDA110E	2.302,87

VM/CP DE



Ref. FKM	€ FKM	Ref. PTFE	€ PTFE
DKOMDA020F	364,29	DKOMDA020P	390,06
DKOMDA025F	390,94	DKOMDA025P	414,25
DKOMDA032F	544,03	DKOMDA032P	492,08
DKOMDA040F	638,68	DKOMDA040P	675,94
DKOMDA050F	693,37	DKOMDA050P	733,35
DKOMDA063F	955,57	DKOMDA063P	948,63
DKOMDA075F	1.146,68	DKOMDA075P	1.138,38
VMOMDA090F	2.481,37	VMOMDA090P	2.122,42
VMOMDA110F	2.930,64	VMOMDA110P	2.565,71

Válvula neumática **DOBLE EFECTO.**
Con bridas DIN.

Disponibles con bridas ANSI 150 libras al mismo precio

CMDM/CP NC *M-M para fusión socket*
CMIM/CP NC *H-H para fusión socket*
CMUIM/CP NC *H-H enlaces fusión socket*
CMFM/CP NC *H-H roscar*



d-Rh	Ref. EPDM	DN	EPDM	FKM	PTFE
20	CMDMNC020E	15	170,44	225,36	254,20
16	CMIMNC016E	12	163,20	190,68	205,12
20	CMIMNC020E	15	163,20	190,68	205,12
20-1/2"	CMUIMNC020E	15	239,76	271,51	285,98
3/8"	CMFMNC038E	12	163,20	190,68	205,12
1/2"	CMFMNC012E	15	163,20	190,68	205,12

Válvula de membrana compacta neumática
NORMALMENTE CERRADA

Código en FKM termina en "F" en lugar de "E"
 Código en PTFE termina en "P" en lugar de "E"
 (A) = Juntas en FKM

CMDM/CP NO *M-M para fusión socket*
CMIM/CP NO *H-H para fusión socket*
CMUIM/CP NO *H-H enlaces fusión socket*
CMFM/CP NO *H-H roscar*



d-Rh	Ref. EPDM	DN	EPDM	FKM	PTFE
20	CMDMNO020E	15	169,00	220,99	251,32
16	CMIMNO016E	12	161,76	187,77	202,22
20	CMIMNO020E	15	161,76	187,77	202,22
20-1/2"	CMUIMNO020E	15	236,90	267,18	283,07
3/8"	CMFMNO038E	12	161,76	187,77	202,22
1/2"	CMFMNO012E	15	161,76	187,77	202,22

Válvula de membrana compacta neumática
NORMALMENTE ABIERTA

Código en FKM termina en "F" en lugar de "E"
 Código en PTFE termina en "P" en lugar de "E"
 (A) = Juntas en FKM

CMDM/CP DE *M-M para fusión socket*
CMIM/CP DE *H-H para fusión socket*
CMUIM/CP DE *H-H enlaces fusión socket*
CMFM/CP DE *H-H roscar*



d-Rh	Ref. EPDM	DN	EPDM	FKM	PTFE
20	CMDMDA020E	15	169,00	220,99	251,32
16	CMIMDA016E	12	187,77	187,77	202,22
20	CMIMDA020E	15	161,76	187,77	202,22
20-1/2"	CMUIMDA020E	15	236,90	267,18	283,07
3/8"	CMFMDA038E	12	161,76	187,77	202,22
1/2"	CMFMDA012E	15	161,76	187,77	202,22

Válvula de membrana compacta neumática
DOBLE EFECTO

Código en FKM termina en "F" en lugar de "E"
 Código en PTFE termina en "P" en lugar de "E"
 (A) = Juntas en FKM



DKBDM/CP NC

d	Ref. EPDM	DN	PN	€ EPDM
20	DKBDMNC020E	15	6	329,62
25	DKBDMNC025E	20	6	349,11
32	DKBDMNC032E	25	6	454,64
40	DKBDMNC040E	32	6	566,09
50	DKBDMNC050E	40	6	591,92
63	DKBDMNC063E	50	6	821,40
75	DKBDMNC075E	65	6	985,66

Válvula de membrana neumática
Normalmente Cerrada.
M-M soldar socket.

Actuador a pistón



DKBUIM/CP NC

d	Ref. EPDM	DN	PN	€ EPDM
20	DKBUIMNC020E	15	6	344,80
25	DKBUIMNC025E	20	6	365,44
32	DKBUIMNC032E	25	6	476,56
40	DKBUIMNC040E	32	6	587,98
50	DKBUIMNC050E	40	6	613,78
63	DKBUIMNC063E	50	6	853,66

Válvula de membrana neumática
Normalmente Cerrada.
Con enlaces H-H para soldar socket.

Actuador a pistón



DKBOM/CP NC

d	Ref. EPDM	DN	PN	€ EPDM
20	DKBOMNC020E	15	6	379,04
25	DKBOMNC025E	20	6	401,52
32	DKBOMNC032E	25	6	532,72
40	DKBOMNC040E	32	6	668,99
50	DKBOMNC050E	40	6	699,45
63	DKBOMNC063E	50	6	970,67
75	DKBOMNC075E	65	6	1.261,90

Válvula de membrana neumática
Normalmente Cerrada.
Con bridas DIN.

Actuador a pistón



DKBOAM/CP NC

d	Ref. EPDM	DN	PN	€ EPDM
½"	DKBOAMNC012E	15	6	379,04
¾"	DKBOAMNC034E	20	6	401,52
1"	DKBOAMNC100E	25	6	532,72
1 ¼"	DKBOAMNC114E	32	6	668,99
1 ½"	DKBOAMNC112E	40	6	699,45
2"	DKBOAMNC200E	50	6	964,75
2 ½"	DKBOAMNC212E	65	6	1.197,91

Válvula de membrana neumática
Normalmente Cerrada.
Con bridas ANSI 150 lbs.

Actuador a pistón



Sistema PP-H Socket

Válvulas de control de presión



VSF

d	Ref. EPDM	DN	PN	€	
				EPDM	PTFE
16	VSFBM016E	10	10	464,12	539,80
20	VSFBM020E	15	10	546,55	576,21
25	VSFBM025E	20	10	602,53	660,30
32	VSFBM032E	25	10	637,62	690,19
40	VSFBM040E	32	10	804,72	882,38
50	VSFBM050E	40	10	1.340,42	1.436,13
63	VSFBM063E	50	10	1.800,23	1.864,62

Válvula de sobrepresión-alivio.
M-M para soldadura a testa.

Código en PTFE termina en "P"
en lugar de "E"
Rango de calibración: 0,5 - 10 bars



VCP

d	Ref. EPDM	DN	PN	€	
				EPDM	PTFE
16	VCPBM016E	10	10	423,74	459,57
20	VCPBM020E	15	10	423,74	459,57
25	VCPBM025E	20	10	566,55	606,65
32	VCPBM032E	25	10	608,58	657,63
40	VCPBM040E	32	10	775,95	816,02
50	VCPBM050E	40	10	1.197,46	1.241,44
63	VCPBM063E	50	10	1.566,66	1.602,56

Válvula retenedora de presión.
M-M para soldadura a testa.

Código en PTFE termina en "P"
en lugar de "E"
Rango de calibración: 0,5 - 10 bars



VPR

d	Ref.	DN	PN	€	
				EPDM	FKM
16	VPRBM016E	10	10	1.183,47	1.226,92
20	VPRBM020E	15	10	1.183,47	1.226,92
25	VPRBM025E	20	10	1.510,39	1.576,52
32	VPRBM032E	25	10	1.510,39	1.576,52
40	VPRBM040E	32	10	1.818,39	1.900,38
50	VPRBM050E	40	10	1.818,39	1.900,38
63	VPRBM063E	50	10	2.571,34	2.651,79

Válvula reductora de presión.
M-M para soldadura a testa.

Código en FKM termina en "F"
en lugar de "E"
Rango de calibración: 0,5 - 9 bars



INDUSTRIA

Sistema PP-H Socket Conectores



MANGUITO

d	Ref. EPDM	Para válvulas	€
16	ENDIM016	VKD-VKR-TKD-SR-RV-VR	15,26
20	ENDIM020	VKD-VKR-TKD-SR-RV-VR	15,26
25	ENDIM025	VKD-VKR-TKD-SR-RV-VR	18,15
32	ENDIM032	VKD-VKR-TKD-SR-RV-VR	20,07
40	ENDIM040	VKD-VKR-TKD-SR-RV-VR	24,80
50	ENDIM050	VKD-VKR-TKD-SR-RV-VR	28,52
63	ENDIM063	VKD-VKR-TKD-SR-RV-VR	36,13
75	ENDIM075	VKD	85,62
90	ENDIM090	VKD	93,46
110	ENDIM110	VKD	129,78

Conector final en PP-H.

H para soldar socket.

MANGUITO

Rh	Ref. EPDM	Para válvulas	€
½"	ENDNM012	VKD-VKR-TKD-SR-RV-VR	15,26
¾"	ENDNM034	VKD-VKR-TKD-SR-RV-VR	18,15
1"	ENDNM100	VKD-VKR-TKD-SR-RV-VR	20,07
1¼"	ENDNM114	VKD-VKR-TKD-SR-RV-VR	24,80
1½"	ENDNM112	VKD-VKR-TKD-SR-RV-VR	28,52
2"	ENDNM200	VKD-VKR-TKD-SR-RV-VR	36,13

Conector final en PP-H.

H rosca NPT.

Q-BBM/L

d	Ref. EPDM	Para válvulas	€
20	QBBML11020	CM-DK	5,10
25	QBBML11025	CM-DK	6,15
32	QBBML11032	CM-DK	7,55
40	QBBML11040	CM-DK	9,80
50	QBBML11050	CM-DK	10,35
63	QBBML11063	CM-DK	14,89

Conector final en PP SDR11.

Para soldar a testa o electrofusión.

MANGUITO

Rh	Ref. EPDM	Para válvulas	€
¾"	ENDFM038	VKD-VKR-TKD-SR-RV-VR	15,26
½"	ENDFM012	VKD-VKR-TKD-SR-RV-VR	14,88
¾"	ENDFM034	VKD-VKR-TKD-SR-RV-VR	17,70
1"	ENDFM100	VKD-VKR-TKD-SR-RV-VR	20,07
1¼"	ENDFM114	VKD-VKR-TKD-SR-RV-VR	24,18
1½"	ENDFM112	VKD-VKR-TKD-SR-RV-VR	27,81
2"	ENDFM200	VKD-VKR-TKD-SR-RV-VR	35,23

Conector final en PP-H.

H rosca gas.

MANGUITO

d	Ref. EPDM	Para válvulas	€
20	ENDDM020	VKD-VKR-TKD-SR-RV-VR	15,26
25	ENDDM025	VKD-VKR-TKD-SR-RV-VR	18,15
32	ENDDM032	VKD-VKR-TKD-SR-RV-VR	20,07
40	ENDDM040	VKD-VKR-TKD-SR-RV-VR	24,80
50	ENDDM050	VKD-VKR-TKD-SR-RV-VR	28,52
63	ENDDM063	VKD-VKR-TKD-SR-RV-VR	36,13
75	ENDDM075	VKD	85,62
90	ENDDM090	VKD	93,46
110	ENDDM110	VKD	116,26

Conector final en PP-H.

M para soldar socket.

CVDM

d	Ref. EPDM	Para válvulas	€
20	CVDM11020	VKD-VKR-TKD-SR-RV-VR	7,21
25	CVDM11025	VKD-VKR-TKD-SR-RV-VR	8,46
32	CVDM11032	VKD-VKR-TKD-SR-RV-VR	10,40
40	CVDM11040	VKD-VKR-TKD-SR-RV-VR	12,94
50	CVDM11050	VKD-VKR-TKD-SR-RV-VR	16,80
63	CVDM11063	VKD-VKR-TKD-SR-RV-VR	21,60
75	CVDM11075	VKD	43,73
90	CVDM11090	VKD	54,96
110	CVDM11110	VKD	66,58

Conector final en PP-H SDR11.

Para soldar a testa o electrofusión.

Accesorios



0805

Sistema PP-H testa / butt welding

INDUSTRIA





Sistema PP-H Testa



**GBM/GKM**

d	Ref. PN6	€ PN6 SDR 17,6	Ref. PN10	€ PN10 SDR 11
20			GKM11020	1,23
25			GKM11025	1,54
32			GKM11032	2,31
40			GKM11040	2,87
50	GKM17050	3,18	GKM11050	4,77
63	GKM17063	7,28	GKM11063	7,54
75	GKM17075	8,56	GKM11075	9,28
90	GKM17090	11,03	GKM11090	14,56
110	GKM17110	17,23	GBM11110	36,18
125	GBM17125	44,79	GBM11125	50,97
140	GBM17140	65,04	GBM11140	68,11
160	GBM17160	69,75	GBM11160	82,98
180	GBM17180	88,68	GBM11180	98,24
200	GBM17200	109,82	GBM11200	146,41
225	GBM17225	135,38	GBM11225	174,65
250	GBM17250	228,61	GBM11250	336,20
280	GBM17280	297,09	GBM11280	437,14
315	GBM17315	410,44	GBM11315	603,50
355	GBM17355	931,41	GBM11355	1.264,13
400	GBM17400	1.296,99	GBM11400	1.736,00
450	GBM17450	1.671,30	GBM11450	2.245,37
500	GBM17500	2.108,94	GBM11500	2.896,51

Curva 90°.

M-M para soldar a testa.

**HBM**

d	Ref. PN6	€ PN6 SDR 17,6	Ref. PN10	€ PN10 SDR 11
20			HBM11020	3,54
25			HBM11025	3,70
32			HBM11032	3,83
40			HBM11040	4,96
50	HBM17050	4,96	HBM11050	6,23
63	HBM17063	8,27	HBM11063	8,95
75	HBM17075	12,07	HBM11075	12,36
90	HBM17090	15,77	HBM11090	17,88
110	HBM17110	33,20	HBM11110	34,04
125	HBM17125	42,18	HBM11125	47,96
140	HBM17140	61,24	HBM11140	64,13
160	HBM17160	67,53	HBM11160	78,13
180	HBM17180	108,65	HBM11180	120,85
200	HBM17200	148,64	HBM11200	165,17
225	HBM17225	177,35	HBM11225	196,88
250	HBM17250	343,14	HBM11250	381,32
280	HBM17280	518,19	HBM11280	575,77
315	HBM17315	644,86	HBM11315	720,39

Codo 45°.

M-M para soldar a testa.

**CBM**

d	Ref. PN6	€ PN6 SDR 17,6	Ref. PN10	€ PN10 SDR 11
20			CBM11020	4,88
25			CBM11025	5,37
32			CBM11032	6,79
40			CBM11040	8,46
50			CBM11050	11,01
63	CBM17063	14,55	CBM11063	14,52
75	CBM17075	22,47	CBM11075	22,47
90	CBM17090	34,12	CBM11090	34,12
110	CBM17110	46,25	CBM11110	46,25
125	CBM17125	57,71	CBM11125	49,97
140	CBM17140	62,51	CBM11140	62,51
160	CBM17160	70,07	CBM11160	70,07
180	CBM17180	91,09	CBM11180	91,09

Tapón.

M para soldar a testa.

d	Ref. PN6	€ PN6 SDR 17,6	Ref. PN10	€ PN10 SDR 11
200	CBM17200	113,45	CBM11200	113,45
225	CBM17225	135,43	CBM11225	135,43
250	CBM17250	172,70	CBM11250	172,70
280	CBM17280	244,69	CBM11280	244,69
315	CBM17315	326,78	CBM11315	326,78
355	CBM17355	422,43	CBM11355	359,60
400	CBM17400	522,95	CBM11400	492,98
450	CBM17450	720,05	CBM11450	745,59
500	CBM17500	862,08	CBM11500	948,07
560	CBM17560	1.099,14		
630	CBM17630	1.667,54		
710	CBM17710	2.516,90		
800	CBM17800	3.945,96		



QBM

d	Ref. PN6	€ PN6 SDR 17,6	Ref. PN10	€ PN10 SDR 11
20			QBM11020	3,41
25			QBM11025	3,41
32			QBM11032	4,04
40	QBM17040	4,65	QBM11040	4,83
50	QBM17050	5,44	QBM11050	5,91
63	QBM17063	6,63	QBM11063	7,36
75	QBM17075	7,82	QBM11075	8,74
90	QBM17090	11,48	QBM11090	12,55
110	QBM17110	14,61	QBM11110	16,14
125	QBM17125	17,90	QBM11125	19,44
140	QBM17140	20,84	QBM11140	22,71
160	QBM17160	25,75	QBM11160	28,65
180	QBM17180	37,64	QBM11180	44,44
200	QBM17200	47,04	QBM11200	48,91
225	QBM17225	52,72	QBM11225	54,51
250	QBM17250	75,32	QBM11250	82,74
280	QBM17280	82,74	QBM11280	90,40
315	QBM17315	101,02	QBM11315	106,51
355	QBM17355	247,99	QBM11355	270,84
400	QBM17400	501,16	QBM11400	533,51
450	QBM17450	582,14	QBM11450	615,97
500	QBM17500	717,67	QBM11500	780,03
560	QBM17560	859,05	QBM11560	1.011,96
630	QBM17630	994,88	QBM11630	1.205,44
710	QBM17710	1.461,12		
800	QBM17800	2.118,95		
900	QBM17900	3.892,56		
1.000	QBM171000	6.381,64		

Manguito portabridas.

M para soldar a testa.



TBM

d	Ref. PN6	€ PN6 SDR 17,6	Ref. PN10	€ PN10 SDR 11
20			TBM11020	3,01
25			TBM11025	3,01
32			TBM11032	3,78
40			TBM11040	6,03
50	TBM17050	9,56	TBM11050	8,16
63	TBM17063	9,80	TBM11063	12,63
75	TBM17075	20,04	TBM11075	25,43
90	TBM17090	28,60	TBM11090	38,01
110	TBM17110	47,46	TBM11110	55,81
125	TBM17125	65,79	TBM11125	76,86
140	TBM17140	77,64	TBM11140	97,38
160	TBM17160	145,99	TBM11160	163,80
180	TBM17180	179,30	TBM11180	209,93
200	TBM17200	244,87	TBM11200	300,79
225	TBM17225	287,47	TBM11225	357,80
250	TBM17250	382,43	TBM11250	455,21
280	TBM17280	431,25	TBM11280	615,44
315	TBM17315	573,58	TBM11315	874,25
355	TBM17355	1.235,12	TBM11355	1.463,21
400	TBM17400	1.688,17	TBM11400	2.184,78
450	TBM17450	2.314,12	TBM11450	2.845,25
500	TBM17500	2.978,02	TBM11500	3.636,37

Te 90°.

M-M-M para soldar a testa.



TRBM

d x dr	Ref. PN6	€ PN6 SDR 17,6	Ref. PN10	€ PN10 SDR 11	d x dr	Ref. PN6	€ PN6 SDR 17,6	Ref. PN10	€ PN10 SDR 11
63 x 50*	TRBM17063050	23,59	TRBM11063050	25,48	180 x 63	TRBM17180063	238,86	TRBM11180063	279,26
75 x 32*			TRBM11075032	39,90	180 x 75	TRBM17180075	238,86	TRBM11180075	279,26
75 x 50*	TRBM17075050	35,71	TRBM11075050	39,90	180 x 90*	TRBM17180090	288,32	TRBM11180090	319,45
75 x 63*	TRBM17075063	36,32	TRBM11075063	40,67	180 x 110*	TRBM17180110	246,14	TRBM11180110	319,45
90 x 32			TRBM11090032	50,44	180 x 125	TRBM17180125	246,14	TRBM11180125	288,25
90 x 50			TRBM11090050	51,84	180 x 160*	TRBM17180160	288,32	TRBM11180160	319,45
90 x 63*	TRBM17090063	50,79	TRBM11090063	56,84	200 x 63*	TRBM17200063	325,93	TRBM11200063	400,45
90 x 75*	TRBM17090075	51,23	TRBM11090075	57,29	200 x 90*	TRBM17200090	329,60	TRBM11200090	404,71
110 x 32			TRBM11110032	74,45	200 x 110*	TRBM17200110	333,22	TRBM11200110	408,88
110 x 50			TRBM11110050	75,98	200 x 125*	TRBM17200125	336,59	TRBM11200125	413,40
110 x 63*	TRBM17110063	75,32	TRBM11110063	84,27	200 x 160*	TRBM17200160	340,85	TRBM11200160	417,89
110 x 75*	TRBM17110075	75,32	TRBM11110075	84,27	225 x 75*	TRBM17225075	486,55	TRBM11225075	540,06
110 x 90*	TRBM17110090	77,15	TRBM11110090	85,44	225 x 90*	TRBM17225090	486,55	TRBM11225090	540,06
125 x 63			TRBM11125063	106,33	225 x 110*	TRBM17225110	488,19	TRBM11225110	542,25
125 x 90			TRBM11125090	117,23	225 x 125	TRBM17225125	391,40	TRBM11225125	486,24
125 x 110*	TRBM17125110	104,64	TRBM11125110	117,23	225 x 160*	TRBM17225160	489,52	TRBM11225160	544,16
140 x 63	TRBM17140063	103,56	TRBM11140063	133,40	225 x 180*	TRBM17225180	490,38	TRBM11225180	546,03
140 x 75	TRBM17140075	104,03	TRBM11140075	133,40	250 x 110	TRBM17250110	513,50	TRBM11250110	641,74
140 x 90	TRBM17140090	105,72	TRBM11140090	135,51	250 x 160	TRBM17250160	523,93	TRBM11250160	654,98
140 x 110	TRBM17140110	107,88	TRBM11140110	135,51	315 x 110			TRBM11315110	1.449,71
160 x 63*	TRBM17160063	207,35	TRBM11160063	230,48	315 x 225			TRBM11315225	1.515,63
160 x 75*	TRBM17160075	213,71	TRBM11160075	232,41	315 x 250			TRBM11315250	1.515,63
160 x 90*	TRBM17160090	213,71	TRBM11160090	232,41					
160 x 110*	TRBM17160110	215,69	TRBM11160110	232,41					
160 x 125	TRBM17160125	201,17	TRBM11160125	224,93					

Te a 90° reducida.

M-M para soldar a testa.

* Espigots LARGOS



QBM FK

d Vál	d Tubo	Ref. PN6	€ PN6 SDR 17,6	Ref. PN10	€ PN10 SDR 11
50	50	QPM17050	6,84	QPM11050	7,43
63	63	QPM17063	8,34	QPM11063	9,19
75	75	QPM17075	9,88	QPM11075	11,06
90	90	QPM17090	14,42	QPM11090	15,77
110	110	QPM17110	18,32	QPM11110	20,94
140	125	QPM17125	22,42	QPM11125	24,40
160	140	QPM17140	26,07	QPM11140	28,50
160	160	QPM17160	32,30	QPM11FK160	55,34
160	180	QPM17180	50,02	QPM11180	59,00
225	200	QBM17FK200	90,35	QPM11FK200	94,27
225	225	QPM17225	65,92	QPM11FK225	105,00
280	250	QPM17250	94,26	QPM11FK250	159,39
280	280	QBM17FK280	153,66	QPM11FK280	174,11
315	315	QBM17FK315	194,20	QPM11FK315	205,15
355	350	QBM17FK355	460,80	QPM11FK355	505,20
400	400	QBM17FK400	871,38	QPM11FK400	940,69

Manguito portabridas
 para válvulas de mariposa FE/FK.
 M para soldar a testa.



QBAM

d	Ref. PN6	€ PN6 SDR 17,6	Ref. PN10	€ PN10 SDR 11
¾"			QBAM11034	4,51
1"			QBAM11100	5,34
1¼"	QBAM17114	6,13	QBAM11114	6,37
1½"	QBAM17112	7,18	QBAM11112	7,79
3"	QBAM17300	15,18	QBAM11300	16,51

Manguito portabridas largo

ANSI 150 lbs.

M para soldar a testa.

ODB



d	Ref.	DN	PN	€
20	ODB020	15	16	8,85
25	ODB025	20	16	9,72
32	ODB032	25	16	12,51
40	ODB040	32	16	15,18
50	ODB050	40	16	17,75
63	ODB063	50	16	22,08
75	ODB075	65	16	24,40
90	ODB090	80	16	29,06
110	ODB110	100	16	35,07
125	ODB125	100	16	35,07
140	ODB140	125	16	52,43
140	ODB140DN125	*125	16	50,37
160	ODB160	150	16	53,41
180	ODB180	150	16	61,24
200	ODB200	200	10	80,21
225	ODB225	200	10	80,21
225	ODB225DN200	*200	10	103,49
250	ODB250	250	10	100,41
280	ODB280	250	10	102,29
280	ODB280DN250	*250	10	107,16
315	ODB315	300	10	156,19
315	ODB315DN300	*300	10	156,94
355	ODB355	350	10	292,39
400	ODB400	400	10	421,93
450	ODB450	450	10	754,43
500	ODB500	500	10	754,43
560	ODB560	600	10	1.023,11
630	ODB630	600	10	1.037,63

Brida loca PP con alma de acero
DIN 2501 DIN 16962/16963.

* Para portabridas PVC-U

A partir de Ø 75 no utilizar
con portabridas socket
(sólo testa)

OAB



d	Ref.	DN	€
½"	OAB012	15	10,99
¾"	OAB034	20	13,68
1"	OAB100	25	16,14
1¼"	OAB114	32	18,59
1½"	OAB112	40	23,19
2"	OAB200	50	28,81
2½"	OAB212	65	35,60
3"	OAB300	80	41,73
4"	OAB400	100	54,44
6"	OAB600	150	102,85
8"	OAB800	200	148,79
10"	OAB810	250	191,63
12"	OAB812	300	295,58
14"	OAB814	350	557,70
16"	OAB816	400	680,04

Brida loca PP con alma de acero
ANSI 150 lbs.

A partir de Ø 75 no utilizar
con portabridas socket
(sólo testa)

ODBC



d	Ref.	DN	PN	€
20	ODBC020	15	16	67,53
25	ODBC025	20	16	68,59
32	ODBC032	25	16	70,33
40	ODBC040	32	16	75,32
50	ODBC050	40	16	85,30
63	ODBC063	50	16	92,89
75	ODBC075	65	16	108,81
90	ODBC090	80	16	119,75
110/125	ODBC110	100	16	163,58
140	ODBC140	125	16	200,88
160/180	ODBC160	150	16	253,51
200/225	ODBC200	200	10	281,56
250/280	ODBC250	250	10	367,93
315	ODBC315	300	10	537,13
355	ODBC355	350	10	1.050,68
400	ODBC400	400	10	1.200,24

Brida ciega PP con alma de acero DIN 2501

OABC



d	Ref.	DN	€
½"	OABC012	15	78,52
¾"	OABC034	20	79,63
1"	OABC100	25	81,59
1¼"	OABC114	32	87,42
1½"	OABC112	40	99,25
2"	OABC200	50	108,02
2½"	OABC212	65	123,41
3"	OABC300	80	139,15
4"	OABC400	100	190,13
6"	OABC600	150	294,77
8"	OABC800	200	327,32
10"	OABC810	250	427,45
12"	OABC812	300	624,68

Brida ciega PP con alma de acero ANSI 150 lbs.

RBM



d x dr	Ref. PN6	€ PN6 SDR 17,6	Ref. PN10	€ PN10 SDR 11
25 x 20			RBM11025020	5,02
32 x 20			RBM11032020	5,81
32 x 25			RBM11032025	5,81
40 x 20			RBM11040020	6,65
40 x 25			RBM11040025	6,65
40 x 32			RBM11040032	6,65
50 x 25			RBM11050025	6,99
50 x 32	RBM17050032	6,65	RBM11050032	6,99
50 x 40	RBM17050040	6,65	RBM11050040	6,99
63 x 32	RBM17063032	8,02	RBM11063032	8,48
63 x 40	RBM17063040	8,02	RBM11063040	8,48
63 x 50	RBM17063050	8,02	RBM11063050	8,48
75 x 32	RBM17075032	10,35	RBM11075032	10,86
75 x 40	RBM17075040	10,35	RBM11075040	10,86
75 x 50	RBM17075050	10,35	RBM11075050	10,86
75 x 63	RBM17075063	10,35	RBM11075063	10,86
90 x 50	RBM17090050	11,52	RBM11090050	12,04
90 x 63	RBM17090063	11,52	RBM11090063	12,04
90 x 75	RBM17090075	11,52	RBM11090075	12,04
110 x 50	RBM17110050	14,69	RBM11110050	15,37
110 x 63	RBM17110063	14,69	RBM11110063	15,37
110 x 75	RBM17110075	14,69	RBM11110075	15,37
110 x 90	RBM17110090	14,69	RBM11110090	15,37
125 x 63	RBM17125063	18,83	RBM11125063	19,79
125 x 75	RBM17125075	18,83	RBM11125075	19,76
125 x 90	RBM17125090	18,83	RBM11125090	19,79
125 x 110	RBM17125110	18,83	RBM11125110	19,76
140 x 75	RBM17140075	22,85	RBM11140075	23,99
140 x 90	RBM17140090	22,85	RBM11140090	23,93
140 x 110	RBM17140110	22,85	RBM11140110	23,93
140 x 125	RBM17140125	22,85	RBM11140125	23,93
160 x 90	RBM17160090	26,68	RBM11160090	28,08
160 x 110	RBM17160110	26,68	RBM11160110	28,08
160 x 125	RBM17160125	26,68	RBM11160125	28,08
160 x 140	RBM17160140	26,68	RBM11160140	28,08
180 x 90	RBM17180090	41,89	RBM11180090	44,05
180 x 110	RBM17180110	39,46		
180 x 125	RBM17180125	39,4594	RBM11180125	38,21
180 x 140	RBM17180140	34,55	RBM11180140	36,29
180 x 160	RBM17180160	34,55	RBM11180160	34,63
200 x 140	RBM17200140	94,71	RBM11200140	99,37
200 x 160	RBM17200160	83,56	RBM11200160	87,68
200 x 180	RBM17200180	74,74	RBM11200180	78,52

Reducción concéntrica.
M-M para soldar a testa.

d x dr	Ref. PN6	€ PN6 SDR 17,6	Ref. PN10	€ PN10 SDR 11
225 x 140	RBM17225140	112,80	RBM11225140	118,45
225 x 160	RBM17225160	96,79	RBM11225160	101,63
225 x 180	RBM17225180	92,41	RBM11225180	96,77
225 x 200	RBM17225200	81,38	RBM11225200	85,25
250 x 160	RBM17250160	129,31	RBM11250160	136,02
250 x 180	RBM17250180	119,84	RBM11250180	125,56
250 x 200	RBM17250200	110,31	RBM11250200	115,80
250 x 225	RBM17250225	104,35	RBM11250225	109,72
280 x 200	RBM17280200	143,93	RBM11280200	151,19
280 x 225	RBM17280225	134,22	RBM11280225	140,96
280 x 250	RBM17280250	130,68	RBM11280250	135,69
315 x 200	RBM17315200	183,73	RBM11315200	192,93
315 x 225	RBM17315225	162,52	RBM11315225	170,69
315 x 250	RBM17315250	148,10	RBM11315250	155,45
315 x 280	RBM17315280	138,71	RBM11315280	145,68
355 x 200	RBM17355200	346,66	RBM11355200	363,96
355 x 225	RBM17355225	333,27	RBM11355225	349,91
355 x 250	RBM17355250	319,72	RBM11355250	335,65
355 x 280	RBM17355280	296,61	RBM11355280	311,45
355 x 315	RBM17355315	287,64	RBM11355315	302,01
400 x 225	RBM17400225	1.460,04	RBM11400225	1.555,38
400 x 250	RBM17400250	1.268,32	RBM11400250	1.426,65
400 x 280	RBM17400280	1.124,86	RBM11400280	1.125,15
400 x 315	RBM17400315	871,43	RBM11400315	871,43
400 x 355	RBM17400355	589,48	RBM11400355	595,79
450 x 280	RBM17450280	1.585,70	RBM11450280	1.585,70
450 x 315	RBM17450315	1.413,11	RBM11450315	1.413,11
450 x 355	RBM17450355	1.070,17	RBM11450355	1.070,17
450 x 400	RBM17450400	790,54	RBM11450400	790,54
500 x 280	RBM17500280	2.504,72	RBM11500280	2.576,35
500 x 315	RBM17500315	1.867,12	RBM11500315	1.919,08
500 x 355	RBM17500355	1.648,19	RBM11500355	1.767,40
500 x 400	RBM17500400	1.420,45	RBM11500400	1.550,49
500 x 450	RBM17500450	1.290,32	RBM11500450	1.398,82
560 x 355	RBM17560355	2.731,53	RBM11560355	2.879,27
560 x 400	RBM17560400	2.287,85	RBM11560400	2.645,75
560 x 450	RBM17560450	1.507,16	RBM11560450	1.572,28
560 x 500	RBM17560500	1.192,66	RBM11560500	1.279,41
630 x 355	RBM17630355	3.675,75		
630 x 400	RBM17630400	3.144,44		
630 x 450	RBM17630450	2.624,05		
630 x 500	RBM17630500	2.515,55		
630 x 560	RBM17630560	1.615,65		
710 x 500	RBM17710500	1.941,79		
710 x 560	RBM17710560	1.624,12		
710 x 630	RBM17710630	1.342,28		
800 x 560	RBM17800560	2.408,14		
800 x 630	RBM17800630	2.031,08		
800 x 710	RBM17800710	1.709,67		

DBMM



d x Rh	Ref.	€ PN10 SDR 11
20 x 1/2"	DBMM11020012	10,01
25 x 3/4"	DBMM11025034	12,92
32 x 1"	DBMM11032100	15,23
40 x 1 1/4"	DBMM11040114	17,83
50 x 1 1/2"	DBMM11050112	22,34
63 x 2"	DBMM11063200	26,44

Terminal rosca hembra largo.

M para soldar a testa o electrofusión - H rosca.

KBFM



d x Rm	Ref.	€ PN10 SDR 11
20 x 1/2"	KBFM11020012	10,06
25 x 3/4"	KBFM11025034	12,07
32 x 1"	KBFM11032100	15,23
40 x 1 1/4"	KBFM11040114	18,32
50 x 1 1/2"	KBFM11050112	30,06
63 x 2"	KBFM11063200	37,96

Terminal rosca macho corto.

M para soldar a testa - M rosca.

BBM/L



d	Ref. EPDM	€ EPDM	Ref. FKM	€ FKM
20	BBML11020E	19,28	BBML11020F	21,62
25	BBML11025E	24,03	BBML11025F	27,09
32	BBML11032E	24,75	BBML11032F	27,41
40	BBML11040E	35,10	BBML11040F	41,49
50	BBML11050E	43,87	BBML11050F	50,81
63	BBML11063E	57,55	BBML11063F	65,57

Unión 3 piezas largo.

SDR 11 (PN10).

M-M para soldar a testa y electrofusión.

BBM/C



d	Ref. EPDM	€ EPDM	Ref. FKM	€ FKM
20	BBMC11020E	19,28	BBMC11020F	21,62
25	BBMC11025E	24,03	BBMC11025F	27,09
32	BBMC11032E	24,75	BBMC11032F	27,41
40	BBMC11040E	35,10	BBMC11040F	41,49
50	BBMC11050E	43,87	BBMC11050F	50,81
63	BBMC11063E	57,55	BBMC11063F	65,57

Unión 3 piezas corto.

SDR 11 (PN10).

M-M para soldar a testa.

Q-BBM/L



d	Ref.	€ SDR 11
20	QBBML11020	5,10
25	QBBML11025	6,15
32	QBBML11032	7,55
40	QBBML11040	9,80
50	QBBML11050	10,35
63	QBBML11063	14,89
75	QBBML11075	21,16
90	QBBML11090	23,61
110	QBBML11110	30,71

Manguito porta tuerca unión 3 piezas largo.

M para soldar a testa y electrofusión.

Q-BBM/C



d	Ref.	€ SDR 11
20	QBBMC11020	5,10
25	QBBMC11025	6,47
32	QBBMC11032	6,47
40	QBBMC11040	10,88
50	QBBMC11050	10,88
63	QBBMC11063	11,94
75	QBBMC11075	16,33
90	QBBMC11090	24,82
110	QBBMC11110	28,97

Manguito porta tuerca unión 3 piezas corto.

M para soldar a testa.

F-BBM/L



d	Ref.	€ SDR 11
20	FBBML11020	8,90
25	FBBML11025	11,11
32	FBBML11032	11,11
40	FBBML11040	16,53
50	FBBML11050	16,53
63	FBBML11063	19,60
75	FBBML11075	27,88
90	FBBML11090	32,06
110	FBBML11110	40,82

Manguito para tuerca unión 3 piezas largo.

SDR 11 (PN10).

M para soldar a testa y electrofusión.

F-BBM/C



d	Ref.	€ SDR 11
20	FBBMC11020	7,71
25	FBBMC11025	9,66
32	FBBMC11032	9,66
40	FBBMC11040	14,37
50	FBBMC11050	14,37
63	FBBMC11063	17,04
75	FBBMC11075	23,22
90	FBBMC11090	30,32
110	FBBMC11110	41,24

Manguito para tuerca unión 3 piezas corto.

SDR 11 (PN10).

M para soldar a testa.

N-BBM



d	Ref.	Rh	€ SDR 11
20	EFGM100	1"	8,27
25	EFGM114	1¼"	8,56
32	EFGM112	1½"	9,93
40	EFGM200	2"	12,68
50	EFGM214	2¼"	19,65
63	EFGM234	2¾"	31,66

Tuerca para unión 3 piezas BBM

largo y corto.

H roscar.

O-BBM



d	Ref. EPDM	€ EPDM	Ref. FKM	€ FKM
20	OR4081E	5,73	OR4081F	12,01
25	OR4112E	2,06	OR4112F	2,26
32	OR4131E	2,94	OR4131F	6,39
40	OR6162E	3,12	OR6162F	9,42
50	OR6187E	3,31	OR6187F	10,74
63	OR6237E	3,62	OR6237F	12,01

Junta tórica para unión 3 piezas BBM

largo y corto.

Tubo y accesorios
Válvulas manuales
Válvulas actuadas
Válvulas de control de presión



0807

Sistema
PVDF

INDUSTRIA



Más información





Sistema PVDF





INDUSTRIA

Sistema PVDF

Tubo y accesorios



Consultar precios



d	Ref.	Epesor mm.	€/m
16	PIPEF21016	1,9	43,34
20	PIPEF21020	1,9	64,97
25	PIPEF21025	1,9	83,67
32	PIPEF21032	2,4	136,37
40	PIPEF21040	2,4	170,83
50	PIPEF21050	3,0	264,14
63	PIPEF21063	3,0	338,20
75	PIPEF21075	3,6	481,25
90	PIPEF21090	4,3	688,92
110	PIPEF21110	5,3	1.030,21

Tubo PVDF ISO 10931-2.
PN16. Barras de 5 m.

Disponible en Pn10
de 63 a 110 mm.
Precios consultar

GIF



d	Ref.	Pack	€
16	GIF016	10	11,46
20	GIF020	10	13,13
25	GIF025	10	16,25
32	GIF032	10	33,84
40	GIF040	5	54,28
50	GIF050	5	80,60
63	GIF063	2	136,61
75	GIF075	2	234,41
90	GIF090	2	347,37
110	GIF110	2	638,55

Codo 90°.

H-H para fusión socket.

HIF



d	Ref.	Pack	€
20	HIF020	10	15,50
25	HIF025	10	22,59
32	HIF032	10	26,47
40	HIF040	5	44,44
50	HIF050	5	49,32
63	HIF063	5	79,60
75	HIF075	2	197,66
90	HIF090	2	300,43
110	HIF110	2	535,19

Codo 45°.

H-H para fusión socket.

TIF



d	Ref.	Pack	€
16	TIF016	10	21,82
20	TIF020	10	23,00
25	TIF025	10	28,25
32	TIF032	10	41,92
40	TIF040	5	65,20
50	TIF050	5	99,50
63	TIF063	5	156,33
75	TIF075	2	295,80
90	TIF090	2	446,14
110	TIF110	2	818,75

Te a 90°.

H-H-H para fusión socket.

CIF



d	Ref.	Pack	€
16*	CIF016	10	14,45
20	CIF020	10	16,25
25	CIF025	10	17,80
32	CIF032	10	20,48
40	CIF040	5	39,04
50	CIF050	5	45,97
63	CIF063	5	74,19
75	CIF075	2	77,87
90	CIF090	2	96,44
110	CIF110	2	141,63

Tapón.

H para fusión socket.

QRNF



d	Ref.	Pack	€
20	QRNF020	10	14,88
25	QRNF025	10	18,73
32	QRNF032	10	19,09
40	QRNF040	5	31,72
50	QRNF050	5	37,52
63	QRNF063	2	57,22
75	QRNF075	2	110,00
90	QRNF090	2	150,15
110	QRNF110	2	195,19

Manguito portabridas.

H para fusión socket.

Consultar precios

QRAF



d	Ref.	Pack	€
¾"	QRAF034	10	22,51
1"	QRAF100	10	19,09
1¼"	QRAF114	5	38,04
1½"	QRAF112	5	45,01
3"	QRAF300	-	234,20

Manguito portabridas **ANSI 150 lbs.**
H para fusión socket.

MIF



d	Ref.	Pack	€
20	MIF020	10	9,46
25	MIF025	10	11,23
32	MIF032	10	15,22
40	MIF040	5	23,00
50	MIF050	5	67,83
63	MIF063	2	97,54
75	MIF075	2	102,64
90	MIF090	2	158,67
110	MIF110	2	293,48

Manguito.
H-H para fusión socket.

RIF



dm x dh	Ref.	Pack	€
20 x 16	RIF020016	10	13,65
25 x 20	RIF025020	10	16,05
32 x 25	RIF032025	10	21,53
40 x 25	RIF040025	10	26,30
40 x 32	RIF040032	10	29,75
50 x 32	RIF050032	5	32,01
50 x 40	RIF050040	5	37,49
63 x 32	RIF063032	5	44,99
63 x 50	RIF063050	5	47,74
75 x 63	RIF075063	2	99,50
90 x 63	RIF090063	2	108,44
90 x 75	RIF090075	2	108,44
110 x 90	RIF110090	2	163,65

Reducción cónica.
M-H para fusión socket.

ODC



d	Ref.	Pack	€
20	ODC020	15	7,31
25	ODC025	20	8,70
32	ODC032	25	10,09
40	ODC040	32	12,34
50	ODC050	40	15,94
63	ODC063	50	17,75
75	ODC075	65	26,42
90	ODC090	80	29,20
110	ODC110	100	40,10

Brida loca.
UNI 2223 PN10. En C-PVC para manguito portabridas.
Descuento de la familia C-PVC.

ODB



d	Ref.	Pack	€
20	ODB020	15	8,85
25	ODB025	20	9,72
32	ODB032	25	12,51
40	ODB040	32	15,18
50	ODB050	40	17,75
63	ODB063	50	22,08
75	ODB075	65	24,40
90	ODB090	80	29,06
125	**ODB125	100	35,07

Brida loca. **Más diámetros en página 320**
En PP con alma de acero. ****Para uso con portabridas QRNF110.**
PN10. Para manguito portabridas.
Versión ANSI 150 lbs (ver OAB página 320).
Descuento de la familia PP-H.

BIGF



d	Ref.	Pack	€ FKM
20	BIGF020F	10	41,75
25	BIGF025F	10	56,29
32	BIGF032F	10	68,37
40	BIGF040F	2	97,54
50	BIGF050F	2	135,84
63	BIGF063F	2	205,21

Unión 3 piezas.
Junta FKM.
H-H para fusión socket.



INDUSTRIA

Sistema PVDF

Válvulas de bola



Consultar precios



BIFXF

d x Rh	Ref.	€ FKM
20 x 1/2"	BIFXF020012F	189,16
25 x 3/4"	BIFXF025034F	280,01
32 x 1"	BIFXF032100F	345,15
40 x 1 1/4"	BIFXF040114F	470,56
50 x 1 1/2"	BIFXF050112F	502,88
63 x 2"	BIFXF063200F	585,09

Unión 3 piezas mixto PVDF / Inox A316L.

Junta FKM.

H-H para fusión socket - roscar inox



BIRXF

d x Rm	Ref.	€ FKM
20 x 1/2"	BIRXF020012F	212,93
25 x 3/4"	BIRXF025034F	312,17
32 x 1"	BIRXF032100F	395,96
40 x 1 1/4"	BIRXF040114F	577,35
50 x 1 1/2"	BIRXF050112F	588,52
63 x 2"	BIRXF063200F	679,70

Unión 3 piezas mixto PVDF / Inox A316L.

Junta FKM.

H-M para fusión socket - roscar inox



VKDIF

d	Ref.	DN	PN	€ FKM
16	VKDIF016F	10	16	217,26
20	VKDIF020F	15	16	225,70
25	VKDIF025F	20	16	281,22
32	VKDIF032F	25	16	360,89
40	VKDIF040F	32	16	467,31
50	VKDIF050F	40	16	673,34
63	VKDIF063F	50	16	1.001,01

Válvula de bola DUAL BLOCK®.

Asiento PTFE (teflón). Bidireccional.

H-H para fusión socket.



VKDDF

d	Ref.	DN	PN	€ FKM
20	VKDDF020F	15	16	265,77
25	VKDDF025F	20	16	332,31
32	VKDDF032F	25	16	420,81
40	VKDDF040F	32	16	531,48
50	VKDDF050F	40	16	775,18
63	VKDDF063F	50	16	1.151,57

Válvula de bola DUAL BLOCK®.

Asiento PTFE (teflón). Bidireccional.

M-M para fusión socket.



VKDIF

d	Ref.	DN	PN	€ FKM
75	VKDIF075F	65	16	2.599,03
90	VKDIF090F	80	16	3.273,49
110	VKDIF110F	100	16	4.771,06

Válvula de bola DUAL BLOCK®.

Asiento PTFE (teflón). Bidireccional.

H-H para fusión socket.



VKDDF

d	Ref.	DN	PN	€ FKM
75	VKDDF075F	65	16	2.858,87
90	VKDDF090F	80	16	3.600,78
110	VKDDF110F	100	16	5.248,26

Válvula de bola DUAL BLOCK®.

Asiento PTFE (teflón). Bidireccional.

M-M para fusión socket.

Consultar precios



VKDBF

d	Ref.	DN	PN	€ FKM
20	VKDBF020F	15	16	234,44
25	VKDBF025F	20	16	332,31
32	VKDBF032F	25	16	420,81
40	VKDBF040F	32	16	531,48
50	VKDBF050F	40	16	775,18
63	VKDBF063F	50	16	1.151,57

Válvula de bola DUAL BLOCK®.
 Asiento PTFE (teflón). Bidireccional.
 M-M para fusión a tope.



VKDOF

d	Ref.	DN	PN	€ FKM
20	VKDOF020F	15	16	497,34
25	VKDOF025F	20	16	602,43
32	VKDOF032F	25	16	777,99
40	VKDOF040F	32	16	954,55
50	VKDOF050F	40	16	1.374,87
63	VKDOF063F	50	16	1.856,73

Válvula de bola DUAL BLOCK®.
 Asiento PTFE (teflón). Bidireccional.
 Con brida loca.

Versión con bridas ANSI 150 lbs
 al mismo precio



VKDBF

d	Ref.	DN	PN	€ FKM
75	VKDBF075F	65	16	2.858,92
90	VKDBF090F	80	16	3.600,78
110	VKDBF110F	100	16	5.248,21

Válvula de bola DUAL BLOCK®.
 Asiento PTFE (teflón). Bidireccional.
 M-M para fusión a tope.



VKDOF

d	Ref.	DN	PN	€ FKM
75	VKDOF075F	65	16	3.378,76
90	VKDOF090F	80	16	4.255,50
110	VKDOF110F	100	16	6.202,43

Válvula de bola DUAL BLOCK®.
 Asiento PTFE (teflón). Bidireccional.
 Con brida loca DIN y ANSI.



SETFLOI

d DIN	d ANSI	Ref.	€ DIN 2501	€ ANSI
20	½"	SETFLOF020	167,43	167,43
25	¾"	SETFLOF025	210,61	210,61
32	1"	SETFLOF032	258,27	258,27
40	1¼"	SETFLOF040	350,15	350,15
50	1½"	SETFLOF050	426,16	426,16

Set embreadado.
 Compuesto por 1 brida, 1 anillo fijación y 1 tuerca.
 Para Válvulas VKD / VKR / SR.

d DIN	d ANSI	Ref.	€ DIN 2501	€ ANSI
63	2"	SETFLOF063	557,38	557,38
75	2½"	SETFLOF075	857,06	857,06
90	3"	SETFLOF090	1.284,34	1.284,34
110	4"	SETFLOF110	1.655,14	1.655,14

d. 75-90-110, es el mismo artículo para DIN y ANSI

Consultar precios



VKRIF

d	Ref.	DN	PN	€ FKM
16	VKRIF016F	10	16	446,40
20	VKRIF020F	15	16	454,88
25	VKRIF025F	20	16	518,22
32	VKRIF032F	25	16	627,66
40	VKRIF040F	32	16	765,55
50	VKRIF050F	40	16	1.272,75
63	VKRIF063F	50	16	2.142,86

Válvula de bola **REGULACIÓN** DUAL BLOCK®.

Asiento PTFE (teflón). Bidireccional
 H-H para fusión socket.



VKRDF

d	Ref.	DN	PN	€ FKM
20	VKRDF020F	15	16	217,00
25	VKRDF025F	20	16	218,24
32	VKRDF032F	25	16	219,48
40	VKRDF040F	32	16	220,72
50	VKRDF050F	40	16	221,96
63	VKRDF063F	50	16	223,20

Válvula de bola **REGULACIÓN** DUAL BLOCK®.

Asiento PTFE (teflón). Bidireccional
 M-M para fusión socket.



VKROF

d	Ref.	DN	PN	€ FKM
20	VKROF020F	15	16	726,49
25	VKROF025F	20	16	839,40
32	VKROF032F	25	16	1.044,76
40	VKROF040F	32	16	1.252,79
50	VKROF050F	40	16	1.974,30
63	VKROF063F	50	16	2.998,62

Válvula de bola **REGULACIÓN** DUAL BLOCK®.

Asiento PTFE (teflón). Bidireccional
 Con brida DIN 2501.



VKROAF

d	Ref.	DN	PN	€ FKM
½"	VKROAF012F	15	16	726,49
¾"	VKROAF034F	20	16	839,40
1"	VKROAF100F	25	16	1.044,76
1¼"	VKROAF114F	32	16	1.252,79
1½"	VKROAF112F	40	16	1.974,30
2"	VKROAF200F	50	16	2.998,62

Válvula de bola **REGULACIÓN** DUAL BLOCK®.

Asiento PTFE (teflón). Bidireccional
 Con bridas ANSI 150 lbs.



INDUSTRIA

Sistema PVDF

Válvulas de mariposa



Consultar precios



FKOF/FM

d	Ref.	DN	€ FKM
50	FKOFFM050F	40	744,27
63	FKOFFM063F	50	788,05
75	FKOFFM075F	65	875,60
90	FKOFFM090F	80	939,44
110	FKOFFM110F	100	981,69
125	FKOFFM140F	125	1.303,71
140	FKOFFM140F	125	1.303,71
160	FKOFFM160F	150	1.394,47
200	FKOFFM225F	200	1.809,10
225	FKOFFM225F	200	1.809,10
250**	FKOFFM280F	250	6.714,38
280**	FKOFFM280F	250	6.714,38
315**	FKOFFM315F	300	7.322,00
355**	FKOFFM355F	355	15.120,40
400**	FKOFFM400F	400	18.533,43

Válvula de mariposa industrial.
A EJE LIBRE.

Para actuar. Cuerpo en PPGR,
eje inoxidable y disco en PVDF

** ANSI 150 lbs bajo pedido
al mismo precio.



FKOF/RM

d	Ref.	DN	€ FKM
75	FKOFRM075F	65	1.755,04
90	FKOFRM090F	80	1.795,58
110	FKOFRM110F	100	1.861,08
125	FKOFRM140F	125	2.215,98
140	FKOFRM140F	125	2.215,98
160	FKOFRM160F	150	2.256,49
200	FKOFRM225F	200	2.873,65
225	FKOFRM225F	200	2.873,65
250**	FKOFRM280F	250	7.266,04
280**	FKOFRM280F	250	7.266,04
315**	FKOFRM315F	300	7.873,66
355**	FKOFRM350F	350	283,96
400**	FKOFRM400F	400	19.856,29

Válvula de mariposa industrial.
CON VOLANTE.

Cuerpo en PPGR,
eje inoxidable y disco en PVDF

** ANSI 150 lbs bajo pedido
al mismo precio.



FKOF/LM

d	Ref.	DN	€ FKM
50	FKOFLM050F	40	832,80
63	FKOFLM063F	50	881,81
75	FKOFLM075F	65	979,68
90	FKOFLM090F	80	1.020,26
110	FKOFLM110F	100	1.083,90
125	FKOFLM140F	125	1.440,68
140	FKOFLM140F	125	1.440,68
160	FKOFLM160F	150	1.481,22
200	FKOFLM225F	200	1.920,85
225	FKOFLM225F	200	1.920,85

Válvula de mariposa industrial.

CON MANETA.
Cuerpo en PPGR,
eje inoxidable y disco en PVDF

** ANSI 150 lbs bajo pedido
al mismo precio.



FKOF/LM

d	Ref.	DN	€ FKM
75	FKOLFLM075F	65	1.218,88
90	FKOLFLM090F	80	1.332,69
110	FKOLFLM110F	100	1.423,24
125	FKOLFLM140F	125	1.893,83
140	FKOLFLM140F	125	1.893,83
160	FKOLFLM160F	150	1.971,10
200	FKOLFLM225F	200	2.428,08
225	FKOLFLM225F	200	2.428,08

Válvula de mariposa industrial. CON MANETA. LUG ISO-DIN.

Cuerpo en PPGR,
eje inoxidable y disco en PVDF

Consultar precios



FKOF/RM

d	Ref.	DN	€ FKM
75	FKOLFRM075F	65	1.994,23
90	FKOLFRM090F	80	2.107,91
110	FKOLFRM110F	100	2.200,50
125	FKOLFRM140F	125	2.669,18
140	FKOLFRM140F	125	2.669,18
160	FKOLFRM160F	150	2.746,30
200	FKOLFRM225F	200	3.380,78
225	FKOLFRM225F	200	3.380,78

Válvula de mariposa industrial. **CON VOLANTE. LUG ISO-DIN.**
 Cuerpo en PPGR, eje inoxidable y disco en PVDF



FKOF/LM

d	Ref.	DN	€ FKM
2½"	FKOALFLM212F	65	1.338,47
3"	FKOALFLM300F	80	1.457,98
4"	FKOALFLM400F	100	1.560,30
5"	FKOALFLM500F	125	2.075,11
6"	FKOALFLM600F	150	2.167,76
8"	FKOALFLM800F	200	2.680,64

Válvula de mariposa industrial. **CON MANETA. LUG ANSI.**
 Cuerpo en PPGR,
 eje inoxidable y disco en PVDF



FKOF/RM

d	Ref.	DN	€ FKM
2½"	FKOALFRM212F	65	2.113,78
3"	FKOALFRM300F	80	2.233,31
4"	FKOALFRM400F	100	2.337,44
5"	FKOALFRM500F	125	2.850,43
6"	FKOALFRM600F	150	2.943,00
8"	FKOALFRM800F	200	3.633,42
10"	FKOALFRM810F	250	9.697,55
12"	FKOALFRM812F	300	10.360,99

Válvula de mariposa industrial. **CON VOLANTE. LUG ANSI.**
 Cuerpo en PPGR, eje inoxidable y disco en PVDF



INDUSTRIA

Sistema PVDF

Válvulas de membrana



Consultar precios



DKDF

d	Ref.	DN	PN	€ EPDM	€ FKM	€ PTFE
20	DKDF020E	15	10	259,46	354,94	396,37
25	DKDF025E	20	10	269,32	369,65	408,68
32	DKDF032E	25	10	310,80	408,68	445,37
40	DKDF040E	32	10	506,58	668,11	714,67
50	DKDF050E	40	10	582,47	746,47	793,05
63	DKDF063E	50	10	736,64	1.008,32	1.000,93
75	DKDF075E	65	10	883,95	1.209,99	1.201,11

Válvula de membrana DIALOCK®.

M-M para soldar socket.

Código en FKM termina en "F" en lugar de "E"
Código en PTFE termina en "P" en lugar de "E"



VMDF

d	Ref.	DN	€ EPDM	€ FKM	€ PTFE
90	VMDF090E	80	2.630,86	3.409,12	2.995,70
110	VMDF110E	100	3.345,49	4.645,15	3.795,91

Válvula de membrana. M-M para fusión socket.

Código en FKM termina en "F" en lugar de "E"
Código en PTFE termina en "P" en lugar de "E"



VMOF

d	Ref.	DN	€ EPDM	€ FKM	€ PTFE
90	VMOF090E	80	3.370,50	4.148,74	3.735,33
110	VMOF110E	100	4.222,18	5.521,83	4.672,60

Válvula de membrana. Con bridas DIN. Bajo pedido con bridas ANSI 150 lbs, la mismo precio.

Código en FKM termina en "F" en lugar de "E"
Código en PTFE termina en "P" en lugar de "E"



DKUIF

d	Ref. FKM	DN	PN	€ EPDM	€ FKM	€ PTFE
20	DKUIF020E	15	10	350,10	445,37	487,09
25	DKUIF025E	20	10	369,65	469,94	509,06
32	DKUIF032E	25	10	440,56	538,43	575,08
40	DKUIF040E	32	10	702,36	863,86	910,40
50	DKUIF050E	40	10	814,99	976,59	1.023,08
63	DKUIF063E	50	10	1.054,82	1.326,38	1.319,20

Válvula de membrana DIALOCK®.

Con enlaces H-H para soldar socket.

Código en FKM termina en "F" en lugar de "E"
Código en PTFE termina en "P" en lugar de "E"



DKOF

d	Ref.	DN	PN	€ EPDM	€ FKM	€ PTFE
20	DKOF020E	15	10	469,20	564,57	606,10
25	DKOF025E	20	10	488,12	588,39	627,48
32	DKOF032E	25	10	539,87	637,76	674,42
40	DKOF040E	32	10	848,05	1.009,55	1.056,09
50	DKOF050E	40	10	937,85	1.101,82	1.148,33
63	DKOF063E	50	10	1.221,92	1.493,63	1.486,17
75	DKOF075E	65	10	1.588,47	1.941,74	1.932,00

Válvula de membrana DIALOCK®.

Con bridas DIN

Código en FKM termina en "F" en lugar de "E"
Código en PTFE termina en "P" en lugar de "E"



DKOAF

d	Ref.	DN	PN	€ EPDM	€ FKM	€ PTFE
½"	DKOAF012E	15	10	469,20	564,57	606,10
¾"	DKOAF034E	20	10	488,12	588,39	627,48
1"	DKOAF100E	25	10	539,87	637,76	674,42
1¼"	DKOAF114E	32	10	848,05	1.009,55	1.056,09
1½"	DKOAF112E	40	10	937,85	1.101,82	1.148,33
2"	DKOAF200E	50	10	1.221,92	1.493,63	1.486,17
2 ½"	DKOAF212E	65	10	1.588,47	1.941,74	1.932,00

Válvula de membrana DIALOCK®.

Con bridas ANSI 150 lbs.

Código en FKM termina en "F" en lugar de "E"
Código en PTFE termina en "P" en lugar de "E"

CMDF

M-M fusión socket.

CMIF

H-H fusión socket.

CMUIF

H-H enlaces socket.

CMFF

H-H roscar.



d-Rh	Ref.	EPDM	DN	€ EPDM	€ FKM	€ PTFE
20	CMDF020E	15	237,50	255,08	266,70	
16	CMIF016E	12	171,27	183,47	203,06	
20	CMIF020E	15	190,99	225,26	246,87	
20	CMUIF020E	15	249,81	266,70	279,03	
¾"	CMFF038E	12	171,27	183,47	203,06	
½"	CMFF012E	15	190,99	225,26	246,87	

Válvula de membrana compacta.

Código en FKM termina en "F" en lugar de "E"
Código en PTFE termina en "P" en lugar de "E"



Sistema PVDF

Válvulas anti-retorno de clapeta



Consultar precios



FROF

d	Ref. FKM	DN	PN	€ FKM	€ PTFE
40	FROF040F	32	6	1.096,38	1.304,29
50	FROF050F	40	6	1.104,29	1.324,94
63	FROF063F	50	6	1.179,43	1.391,72
75	FROF075F	65	6	1.204,33	1.457,02
90	FROF090F	80	6	1.776,68	2.149,82
110	FROF110F	100	6	2.192,59	2.624,68
140	FROF140F	125	6	2.424,83	2.933,52
160	FROF160F	150	6	3.910,32	4.692,27
225	FROF225F	200	6	6.850,15	8.288,31
280	FROF280F	250	6	10.312,26	12.580,68
315	FROF315F	300	6	15.608,96	19.198,87

Válvula anti-retorno de clapeta sin resorte. **ISO/DIN.**

Código en PTFE termina en "P" en lugar de "F"



FROF

d	Ref. FKM	DN	PN	€ FKM	€ PTFE
40	FROF040FMLX	32	6	1.235,59	1.443,58
50	FROF050FMLX	40	6	1.243,50	1.464,18
63	FROF063FMLX	50	6	1.327,57	1.539,93
75	FROF075FMLX	65	6	1.360,56	1.613,17
90	FROF090FMLX	80	6	1.940,83	2.314,08
110	FROF110FMLX	100	6	2.373,74	2.805,87
140	FROF140FMLX	125	6	2.606,00	3.114,72
160	FROF160FMLX	150	6	4.144,00	4.925,95
225	FROF225FMLX	200	6	7.116,87	8.555,08
280	FROF280FMLX	250	6	10.630,97	12.899,46
315	FROF315FMLX	300	6	15.976,79	19.566,63

Válvula anti-retorno de clapeta con resorte inox. **ISO/DIN.**

Código en PTFE termina en "PMLX" en lugar de "FMLX"



FROAF

d	Ref. FKM	DN	PN	€ FKM	€ PTFE
1¼"	FROAF114F	32	6	1.215,38	1.472,42
1½"	FROAF112F	40	6	1.209,25	1.484,18
2"	FROAF200F	50	6	1.293,17	1.574,66
2½"	FROAF212F	65	6	1.312,74	1.668,94
3"	FROAF300F	80	6	1.946,85	2.362,00
4"	FROAF400F	100	6	2.402,68	2.891,93
5"	FROAF500F	125	6	2.641,95	3.190,17
6"	FROAF600F	150	6	4.245,02	4.884,19
8"	FROAF800F	200	6	7.552,66	8.233,85
10"	FROAF810F	250	6	11.208,92	12.131,11
12"	FROAF812F	300	6	17.205,74	18.302,07

Válvula anti-retorno de clapeta sin resorte. **ANSI 150 lbs.**

Código en PTFE termina en "P" en lugar de "F"



FROAF

d	Ref. FKM	DN	PN	€ FKM	€ PTFE
1¼"	FROAF114FMLX	32	6	1.354,58	1.611,67
1½"	FROAF112FMLX	40	6	1.348,51	1.623,41
2"	FROAF200FMLX	50	6	1.440,71	1.722,81
2½"	FROAF212FMLX	65	6	1.468,93	1.825,11
3"	FROAF300FMLX	80	6	2.111,04	2.526,21
4"	FROAF400FMLX	100	6	2.583,96	3.073,14
5"	FROAF500FMLX	125	6	2.823,18	3.371,29
6"	FROAF600FMLX	150	6	4.478,63	5.117,84
8"	FROAF800FMLX	200	6	7.819,38	8.500,54
10"	FROAF810FMLX	250	6	11.527,69	12.449,85
12"	FROAF812FMLX	300	6	17.573,65	18.669,93

Válvula anti-retorno de clapeta con resorte inox. **ANSI 150 lbs.**

Código en PTFE termina en "PMLX" en lugar de "FMLX"



INDUSTRIA

Sistema PVDF

Válvulas de bola actuadas



Consultar precios



SRIF

d	Ref.	DN	PN	€ FKM
20	SRIF020F	15	16	304,88
25	SRIF025F	20	16	375,13
32	SRIF032F	25	16	436,51
40	SRIF040F	32	16	763,28
50	SRIF050F	40	16	822,49
63	SRIF063F	50	16	1.390,50

Válvula de bola anti-retorno.

Juntas en FKM.

M-H para fusión socket.

VKDIF/CE

Soldar

ACTUACIÓN ELÉCTRICA
24-240 V AC/DCACTUACIÓN ELÉCTRICA CON BLOQUE DE SEGURIDAD
24-240 V AC/DC

d	Ref.	€	Ref.	€
16	VKFE016F2D	1.008,09	VKFE016F2BD	1.729,19
20	VKFE020F2D	1.017,79	VKFE020F2BD	1.738,88
25	VKFE025F2D	1.085,14	VKFE025F2BD	1.806,21
32	VKFE032F2D	1.176,21	VKFE032F2BD	1.897,29
40	VKFE040F2D	1.307,51	VKFE040F2BD	2.028,59
50	VKFE050F2D	1.543,33	VKFE050F2BD	2.264,38
63	VKFE063F2D	1.923,04	VKFE063F2BD	2.644,11
75	VKFE075F2D	4.010,67	VKFE075F2BD	4.731,75
90	VKFE090F2D	4.782,68	VKFE090F2BD	5.503,75
110	VKFE110F2D	6.987,91	VKFE110F2BD	7.709,01

Válvula de bola motorizada
en PVDF 2 vías DUAL BLOCK®. Actuación eléctrica.

Disponemos de otras conexiones bajo pedido: bridas, soldar macho y roscar (GAS y NPT)

Bajo pedido podemos suministrar otros actuadores: VALPES, BELIMO...

Bajo pedido también disponibles en 12V AC/DC

Consultar precios



VKRIF/CE

Soldar

ACTUACIÓN ELÉCTRICA 24-240 V AC/DC CON POSICIONADOR 4-20 mA

d	Ref.	€
16	VRFE016F2PD	1.873,67
20	VRFE020F2PD	1.883,30
25	VRFE025F2PD	1.959,63
32	VRFE032F2PD	2.084,91
40	VRFE040F2PD	2.252,15
50	VRFE050F2PD	2.832,69
63	VRFE063F2PD	3.833,35

Válvula de bola **REGULACIÓN** motorizada en PVDF 2 vías DUAL BLOCK®.

Actuación eléctrica con posicionador 4-20 mA.

Disponemos de otras conexiones bajo pedido: bridas, soldar macho y roscar (GAS y NPT)

Bajo pedido podemos suministrar otros actuadores: VALPES, BELIMO...

Bajo pedido también disponibles en 12V AC/DC

VKDIF/CP

Soldar

ACTUACIÓN NEUMÁTICA ALUMINIO

ACTUACIÓN NEUMÁTICA ALUMINIO CON ELECTROVÁLVULA, FINALES DE CARRERA (ELECTROMECAÑICOS) Y REGULADORES DE ESCAPE

d	DOBLE EFECTO		SIMPLE EFECTO		DOBLE EFECTO		SIMPLE EFECTO	
	Ref.	€	Ref.	€	Ref.	€	Ref.	€
16	VKFP016FDED	569,49	VKFP016FSED	609,43	VKFP016FDEFD	830,31	VKFP016FSEFD	884,03
20	VKFP020FDED	579,20	VKFP020FSED	619,11	VKFP020FDEFD	840,02	VKFP020FSEFD	893,71
25	VKFP025FDED	646,56	VKFP025FSED	686,44	VKFP025FDEFD	907,36	VKFP025FSEFD	961,04
32	VKFP032FDED	737,61	VKFP032FSED	777,53	VKFP032FDEFD	998,43	VKFP032FSEFD	1.052,12
40	VKFP040FDED	868,91	VKFP040FSED	908,82	VKFP040FDEFD	1.129,73	VKFP040FSEFD	1.183,42
50	VKFP050FDED	1.104,71	VKFP050FSED	1.222,18	VKFP050FDEFD	1.365,52	VKFP050FSEFD	1.496,78
63	VKFP063FDED	1.484,44	VKFP063FSED	1.704,44	VKFP063FDEFD	1.745,26	VKFP063FSEFD	1.979,04
75	VKFP075FDED	3.362,33	VKFP075FSED	3.518,00	VKFP075FDEFD	3.623,18	VKFP075FSEFD	3.792,61
90	VKFP090FDED	4.134,37	VKFP090FSED	4.290,00	VKFP090FDEFD	4.395,16	VKFP090FSEFD	4.564,63
110	VKFP110FDED	5.883,77	VKFP110FSED	6.434,62	VKFP110FDEFD	6.144,57	VKFP110FSEFD	6.709,24

Válvula de bola motorizada en PVDF 2 vías DUAL BLOCK®.

Actuación neumática.

Disponemos de otras conexiones bajo pedido: bridas, soldar macho y roscar (NPT)

Las válvulas neumáticas se configuran NC (normalmente cerrada) de serie.

La configuración NA (normalmente abierta) se debe especificar en el pedido

Consultar precios



VKRIF/CP

Soldar

ACTUACIÓN NEUMÁTICA ALUMINIO DOBLE EFECTO
 CON POSICIONADOR 4-20 mA

ACTUACIÓN NEUMÁTICA ALUMINIO SIMPLE EFECTO
 CON POSICIONADOR 4-20 mA

d	Ref.	€	Ref.	€
16	VRFP016FDEPD	3.155,46	VRFP016FSEPD	3.195,37
20	VRFP020FDEPD	3.165,17	VRFP020FSEPD	3.205,10
25	VRFP025FDEPD	3.241,41	VRFP025FSEPD	3.281,35
32	VRFP032FDEPD	3.366,66	VRFP032FSEPD	3.406,60
40	VRFP040FDEPD	3.533,96	VRFP040FSEPD	3.573,87
50	VRFP050FDEPD	4.114,52	VRFP050FSEPD	4.231,99
63	VRFP063FDEPD	5.115,13	VRFP063FSEPD	5.335,17

Válvula de bola **REGULACIÓN** motorizada en PVDF 2 vías DUAL BLOCK®.

Actuación neumática con posicionador 4-20 mA.

Disponemos de otras conexiones bajo pedido: bridas, soldar macho y roscar (NPT)
 Las válvulas neumáticas se configuran NC (normalmente cerrada) de serie.
 La configuración NA (normalmente abierta) se debe especificar en el pedido.

VKDIF/CP

Soldar

ACTUACIÓN NEUMÁTICA POLIAMIDA

ACTUACIÓN NEUMÁTICA ALUMINIO CON ELECTROVÁLVULA, FINALES DE CARRERA (ELECTROMECAÑICOS) Y REGULADORES DE ESCAPE

d	DOBLE EFECTO		SIMPLE EFECTO		DOBLE EFECTO		SIMPLE EFECTO	
	Ref.	€	Ref.	€	Ref.	€	Ref.	€
16	VKFP016FDEP	593,88	VKFP016FSEP	623,97	VKFP016FDEFP	935,03	VKFP016FSEFP	965,14
20	VKFP020FDEP	603,56	VKFP020FSEP	633,66	VKFP020FDEFP	944,72	VKFP020FSEFP	974,82
25	VKFP025FDEP	947,09	VKFP025FSEP	700,95	VKFP025FDEFP	1.012,06	VKFP025FSEFP	1.042,15
32	VKFP032FDEP	761,97	VKFP032FSEP	927,36	VKFP032FDEFP	1.103,13	VKFP032FSEFP	1.268,55
40	VKFP040FDEP	893,27	VKFP040FSEP	1.058,69	VKFP040FDEFP	1.234,46	VKFP040FSEFP	1.399,87
50	VKFP050FDEP	1.129,03	VKFP050FSEP	1.452,35	VKFP050FDEFP	1.470,22	VKFP050FSEFP	1.793,52
63	VKFP063FDEP	1.774,10	VKFP063FSEP	1.860,54	VKFP063FDEFP	2.115,29	VKFP063FSEFP	2.201,73
75	VKFP075FDEP	3.530,07	VKFP075FSEP	3.853,98	VKFP075FDEFP	3.871,29	VKFP075FSEFP	4.195,12
90	VKFP090FDEP	4.302,08	VKFP090FSEP	4.626,02	VKFP090FDEFP	4.643,24	VKFP090FSEFP	4.967,18
110	VKFP110FDEP	6.008,04	VKFP110FSEP	6.359,58	VKFP110FDEFP	6.349,21	VKFP110FSEFP	6.700,77

Válvula de bola motorizada en PVDF 2 vías DUAL BLOCK®.

Actuación neumática.

Disponemos de otras conexiones bajo pedido: bridas, soldar macho y roscar (GAS y NPT)
 Las válvulas neumáticas se configuran NC (normalmente cerrada) de serie.
 La configuración NA (normalmente abierta) se debe especificar en el pedido.



INDUSTRIA

Sistema PVDF

Válvulas de mariposa actuadas



Consultar precios

VKRIF/CP

Soldar

ACTUACIÓN NEUMÁTICA POLIAMIDA DOBLE EFECTO
CON POSICIONADOR 4-20 mA

d	Ref.	€
16	VRFP016FDEPD	3.155,46
20	VRFP020FDEPD	3.165,17
25	VRFP025FDEPD	3.241,41
32	VRFP032FDEPD	3.366,66
40	VRFP040FDEPD	3.533,96
50	VRFP050FDEPD	4.114,52
63	VRFP063FDEP	5.115,13

S
O
L
D
A
R

ACTUACIÓN NEUMÁTICA POLIAMIDA SIMPLE
EFECTO CON POSICIONADOR 4-20 mA

Ref.	€
VRFP016FSEPP	2.613,96
VRFP020FSEPP	2.623,67
VRFP025FSEPP	2.699,89
VRFP032FSEPP	2.960,48
VRFP040FSEPP	3.127,78
VRFP050FSEPP	3.866,24
VRFP063FSEPP	4.895,31

S
O
L
D
A
R

Válvula de bola REGULACIÓN motorizada en PVDF 2 vías DUAL BLOCK®.

Actuación neumática con posicionador 4-20 mA.

Disponemos de otras conexiones bajo pedido: bridas, soldar macho y roscar (NPT)

Las válvulas neumáticas se configuran NC (normalmente cerrada) de serie. La configuración NA (normalmente abierta) se debe especificar en el pedido

FKOF/CE

ACTUACIÓN ELÉCTRICA
24-240 V AC/DC

d	Ref.	€
50	FKFE050F2D	1.470,82
63	FKFE063F2D	1.515,32
75	FKFE075F2D	1.941,96
90	FKFE090F2D	2.007,01
110	FKFE110F2D	2.049,89
125	FKFE140F2D	2.853,23
140	FKFE140F2D	2.853,23
160	FKFE160F2D	3.260,10
200	FKFE225F2D	3.869,02
225	FKFE225F2D	3.869,02
250	FKFE280F2D	8.957,76
280	FKFE280F2D	8.957,76
315	FKFE315F2D	9.576,10

F
K
M

ACTUACIÓN ELÉCTRICA CON BLOQUE DE SEGURIDAD
24-240 V AC/DC

Ref.	€
FKFE050F2BD	2.191,89
FKFE063F2BD	2.236,42
FKFE075F2BD	2.663,01
FKFE090F2BD	2.728,01
FKFE110F2BD	2.770,94
FKFE140F2BD	3.574,36
FKFE140F2BD	3.574,36
FKFE160F2BD	4.103,91
FKFE225F2BD	4.712,85
FKFE225F2BD	4.712,85
FKFE280F2BD	9.801,56
FKFE280F2BD	9.801,56
FKFE315F2BD	10.419,92

F
K
M

Válvula de mariposa industrial motorizada cuerpo en PPGR y disco en PVDF.

Actuación eléctrica.

Bajo pedido podemos suministrar otros actuadores: VALPES, BELIMO...
Bajo pedido también disponibles en 12V AC/DC

Consultar precios



FKOF/CP

d	ACTUACIÓN NEUMÁTICA ALUMINIO				ACTUACIÓN NEUMÁTICA ALUMINIO CON ELECTROVÁLVULA, FINALES DE CARRERA (ELECTROMECAÑICOS) Y REGULADORES DE ESCAPE			
	DOBLE EFECTO		SIMPLE EFECTO		DOBLE EFECTO		SIMPLE EFECTO	
	Ref.	€	Ref.	€	Ref.	€	Ref.	€
50	FKFP050FDED	1.031,78	FKFP050FSED	1.149,25	FKFP050FDEFD	1.292,60	FKFP050FSEFD	1.423,85
63	FKFP063FDED	1.076,35	FKFP063FSED	1.193,80	FKFP063FDEFD	1.337,15	FKFP063FSEFD	1.468,37
75	FKFP075FDED	1.211,85	FKFP075FSED	1.385,43	FKFP075FDEFD	1.472,69	FKFP075FSEFD	1.659,98
90	FKFP090FDED	1.358,24	FKFP090FSED	1.513,87	FKFP090FDEFD	1.619,06	FKFP090FSEFD	1.788,47
110	FKFP110FDED	1.401,14	FKFP110FSED	1.987,08	FKFP110FDEFD	1.661,94	FKFP110FSEFD	2.261,67
125	FKFP140FDED	1.771,42	FKFP140FSED	2.652,02	FKFP140FDEFD	2.032,24	FKFP140FSEFD	2.926,62
140	FKFP140FDED	1.771,42	FKFP140FSED	2.652,02	FKFP140FDEFD	2.032,24	FKFP140FSEFD	2.926,62
160	FKFP160FDED	1.863,76	FKFP160FSED	2.744,38	FKFP160FDEFD	2.124,58	FKFP160FSEFD	3.018,96
200	FKFP225FDED	2.653,26	FKFP225FSED	3.861,86	FKFP225FDEFD	2.914,08	FKFP225FSEFD	4.136,48
225	FKFP225FDED	2.653,26	FKFP225FSED	3.861,86	FKFP225FDEFD	2.914,08	FKFP225FSEFD	4.136,48
250	FKFP280FDED	7.977,20	FKFP280FSED	10.539,42	FKFP280FDEFD	8.237,99	FKFP280FSEFD	10.814,05
280	FKFP280FDED	7.977,20	FKFP280FSED	10.539,42	FKFP280FDEFD	8.237,99	FKFP280FSEFD	10.814,05
315	FKFP315FDED	8.944,04	FKFP315FSED	12.481,49	FKFP315FDEFD	9.204,83	FKFP315FSEFD	12.756,09

Válvula de mariposa industrial motorizada
 cuerpo en PPGR y disco en PVDF.

Actuación neumática.

Las válvulas neumáticas se configuran NC (normalmente cerrada) de serie.
 La configuración NA (normalmente abierta) se debe especificar en el pedido.

FKOF/CP

d	ACTUACIÓN NEUMÁTICA POLIAMIDA				ACTUACIÓN NEUMÁTICA POLIAMIDA CON ELECTROVÁLVULA, FINALES DE CARRERA (ELECTROMECAÑICOS) Y REGULADORES DE ESCAPE			
	DOBLE EFECTO		SIMPLE EFECTO		DOBLE EFECTO		SIMPLE EFECTO	
	Ref.	€	Ref.	€	Ref.	€	Ref.	€
50	FKFP050FDEP	1.170,83	FKFP050FSEP	1.382,93	FKFP050FDEFP	1.511,99	FKFP050FSEFP	1.724,15
63	FKFP063FDEP	1.215,38	FKFP063FSEP	1.427,48	FKFP063FDEFP	1.556,54	FKFP063FSEFP	1.768,66
75	FKFP075FDEP	1.304,44	FKFP075FSEP	1.516,55	FKFP075FDEFP	1.645,63	FKFP075FSEFP	1.857,74
90	FKFP090FDEP	1.494,63	FKFP090FSEP	1.581,15	FKFP090FDEFP	1.835,82	FKFP090FSEFP	1.922,29
110	FKFP110FDEP	1.537,53	FKFP110FSEP	1.877,82	FKFP110FDEFP	1.878,75	FKFP110FSEFP	2.219,01
125	FKFP140FDEP	1.854,15	FKFP140FSEP	2.584,58	FKFP140FDEFP	2.195,29	FKFP140FSEFP	2.925,77
140	FKFP140FDEP	1.854,15	FKFP140FSEP	2.584,58	FKFP140FDEFP	2.195,29	FKFP140FSEFP	2.925,77
160	FKFP160FDEP	2.185,23	FKFP160FSEP	2.676,92	FKFP160FDEFP	2.526,38	FKFP160FSEFP	3.018,11
200	FKFP225FDEP	2.629,08	FKFP225FSEP	3.643,96	FKFP225FDEFP	2.970,26	FKFP225FSEFP	3.985,12
225	FKFP225FDEP	2.629,08	FKFP225FSEP	3.643,96	FKFP225FDEFP	2.970,26	FKFP225FSEFP	3.985,12
250*	FKFP280FDEP	8.209,46	FKFP280FSEP	10.385,08	FKFP280FDEFP	8.550,65	FKFP280FSEFP	10.726,24
280*	FKFP280FDEP	8.209,46	FKFP280FSEP	10.385,08	FKFP280FDEFP	8.550,65	FKFP280FSEFP	10.726,24
315*	FKFP315FDEP	8.827,85	FKFP315FSEP	11.003,44	FKFP315FDEFP	9.169,01	FKFP315FSEFP	11.344,63

Válvula de mariposa industrial motorizada
 cuerpo en PPGR y disco en PVDF.

Actuación neumática.

Las válvulas neumáticas se configuran NC (normalmente cerrada) de serie.
 La configuración NA (normalmente abierta) se debe especificar en el pedido.

* Actuadores de aluminio



INDUSTRIA

Sistema PVDF

Válvulas de membrana actuadas



Consultar precios

**DK/CP NC**

d	Modelo	DN	Ref. EPDM	€ EPDM
20	DKDF/CP NC	15	DKDFNC020E	553,88
25	DKDF/CP NC	20	DKDFNC025E	577,81
32	DKDF/CP NC	25	DKDFNC032E	711,63
40	DKDF/CP NC	32	DKDFNC040E	1.060,95
50	DKDF/CP NC	40	DKDFNC050E	1.194,39
63	DKDF/CP NC	50	DKDFNC063E	1.631,11
75	DKDF/CP NC	65	DKDFNC075E	1.957,31
90	VMD/CP NC	80	VMDFNC090E	3.830,47
110	VMD/CP NC	100	VMDFNC110E	4.817,62

**VM/CP NC**

Ref. FKM	€ FKM	Ref. PTFE	€ PTFE
DKDFNC020F	636,80	DKDFNC020P	667,11
DKDFNC025F	660,72	DKDFNC025P	692,65
DKDFNC032F	803,64	DKDFNC032P	841,23
DKDFNC040F	1.218,68	DKDFNC040P	1.259,98
DKDFNC050F	1.363,03	DKDFNC050P	1.393,54
DKDFNC063F	1.917,65	DKDFNC063P	1.913,51
DKDFNC075F	2.301,21	DKDFNC075P	2.296,21
VMDFNC090F	4.579,64	VMDFNC090P	4.179,67
VMDFNC110F	5.532,32	VMDFNC110P	5.385,28

Válvula neumática **NORMALMENTE CERRADA.**

M-M soldar socket.

**DK/CP NO**

d	Modelo	DN	Ref. EPDM	€ EPDM
20	DKDF/CP NO	15	DKDFNO020E	473,34
25	DKDF/CP NO	20	DKDFNO025E	497,34
32	DKDF/CP NO	25	DKDFNO032E	544,82
40	DKDF/CP NO	32	DKDFNO040E	883,82
50	DKDF/CP NO	40	DKDFNO050E	1.005,93
63	DKDF/CP NO	50	DKDFNO063E	1.296,75
75	DKDF/CP NO	65	DKDFNO075E	1.556,05
90	VMD/CP NO	80	VMDFNO090E	3.367,95
110	VMD/CP NO	100	VMDFNO110E	4.235,96

**VM/CP NO**

Ref. FKM	€ FKM	Ref. PTFE	€ PTFE
DKDFNO020F	556,33	DKDFNO020P	586,62
DKDFNO025F	580,23	DKDFNO025P	612,18
DKDFNO032F	870,45	DKDFNO032P	911,89
DKDFNO040F	1.084,78	DKDFNO040P	1.135,73
DKDFNO050F	1.225,91	DKDFNO050P	1.286,19
DKDFNO063F	1.660,77	DKDFNO063P	1.655,57
DKDFNO075F	1.992,93	DKDFNO075P	1.986,64
VMDFNO090F	4.239,69	VMDFNO090P	3.772,94
VMDFNO110F	4.820,40	VMDFNO110P	4.861,29

Válvula neumática **NORMALMENTE ABIERTA.**

M-M soldar socket.

**DK/CP DE**

d	Modelo	DN	Ref. EPDM	€ EPDM
20	DKDF/CP DE	15	DKDFDA020E	392,84
25	DKDF/CP DE	20	DKDFDA025E	416,82
32	DKDF/CP DE	25	DKDFDA032E	648,11
40	DKDF/CP DE	32	DKDFDA040E	803,53
50	DKDF/CP DE	40	DKDFDA050E	865,52
63	DKDF/CP DE	50	DKDFDA063E	866,76
75	DKDF/CP DE	65	DKDFDA075E	868,00
90	VMD/CP DE	80	VMDFDA090E	3.738,52
110	VMD/CP DE	100	VMDFDA110E	4.702,08

VM/CP DE

Ref. FKM	€ FKM	Ref. PTFE	€ PTFE
DKDFDA020F	475,81	DKDFDA020P	506,14
DKDFDA025F	499,76	DKDFDA025P	531,69
DKDFDA032F	780,89	DKDFDA032P	820,03
DKDFDA040F	986,15	DKDFDA040P	1.032,47
DKDFDA050F	876,68	DKDFDA050P	887,84
DKDFDA063F	877,92	DKDFDA063P	889,08
DKDFDA075F	879,16	DKDFDA075P	890,32
VMDFDA090F	4.610,26	VMDFDA090P	4.143,59
VMDFDA110F	5.241,82	VMDFDA110P	5.338,75

Válvula neumática **DOBLE EFECTO.**

M-M soldar socket.

Consultar precios



DK/CP NC

d	Modelo	DN	Ref. EPDM	€ EPDM	Ref. FKM	€ FKM	Ref. PTFE	€ PTFE
20	DKUIF/CP NC	15	DKUIFNC020E	625,62	DKUIFNC020F	707,07	DKUIFNC020P	738,95
25	DKUIF/CP NC	20	DKUIFNC025E	657,53	DKUIFNC025F	740,57	DKUIFNC025P	772,50
32	DKUIF/CP NC	25	DKUIFNC032E	831,83	DKUIFNC032F	923,86	DKUIFNC032P	963,26
40	DKUIF/CP NC	32	DKUIFNC040E	1.243,03	DKUIFNC040F	1.400,78	DKUIFNC040P	1.442,10
50	DKUIF/CP NC	40	DKUIFNC050E	1.425,96	DKUIFNC050F	1.594,57	DKUIFNC050P	1.627,09
63	DKUIF/CP NC	50	DKUIFNC063E	1.952,14	DKUIFNC063F	2.238,48	DKUIFNC063P	2.234,41

Válvula neumática **NORMALMENTE CERRADA.**

Con enlaces H-H para soldar socket.



DK/CP NO

d	Modelo	DN	Ref. EPDM	€ EPDM	Ref. FKM	€ FKM	Ref. PTFE	€ PTFE
20	DKUIF/CP NO	15	DKUIFNO020E	545,08	DKUIFNO020F	626,55	DKUIFNO020P	658,43
25	DKUIF/CP NO	20	DKUIFNO025E	577,04	DKUIFNO025F	660,08	DKUIFNO025P	692,01
32	DKUIF/CP NO	25	DKUIFNO032E	885,83	DKUIFNO032F	1.029,07	DKUIFNO032P	1.069,19
40	DKUIF/CP NO	32	DKUIFNO040E	1.118,68	DKUIFNO040F	1.322,11	DKUIFNO040P	1.370,52
50	DKUIF/CP NO	*40	DKUIFNO050E	1.304,55	DKUIFNO050F	1.524,59	DKUIFNO050P	1.585,07
63	DKUIF/CP NO	*50	DKUIFNO063E	1.707,93	DKUIFNO063F	2.074,61	DKUIFNO063P	2.069,48

Válvula neumática **NORMALMENTE ABIERTA.**

* Válvulas NO-DE

Con enlaces H-H para soldar socket.



DK/CP DE

d	Modelo	DN	Ref. EPDM	€ EPDM	Ref. FKM	€ FKM	Ref. PTFE	€ PTFE
20	DKUIF/CP DE	15	DKUIFDA020E	464,63	DKUIFDA020F	546,05	DKUIFDA020P	577,96
25	DKUIF/CP DE	20	DKUIFDA025E	496,54	DKUIFDA025F	579,58	DKUIFDA025P	611,49
32	DKUIF/CP DE	25	DKUIFDA032E	794,70	DKUIFDA032F	928,68	DKUIFDA032P	966,71
40	DKUIF/CP DE	32	DKUIFDA040E	1.017,02	DKUIFDA040F	1.201,94	DKUIFDA040P	1.245,92
50	DKUIF/CP DE	*40	DKUIFDA050E	965,96	DKUIFDA050F	973,40	DKUIFDA050P	980,84
63	DKUIF/CP DE	*50	DKUIFDA063E	967,20	DKUIFDA063F	974,64	DKUIFDA063P	982,08

Válvula neumática **DOBLE EFECTO.**

Con enlaces H-H para soldar socket.

Consultar precios



DK/CP NC



VM/CP NC

d	Modelo	DN	€		€		€	
			Ref. EPDM	EPDM	Ref. FKM	FKM	Ref. PTFE	PTFE
20	DKOF/CP NC	15	DKOFNC020E	719,97	DKOFNC020F	802,99	DKOFNC020P	833,32
25	DKOF/CP NC	20	DKOFNC025E	751,13	DKOFNC025F	834,09	DKOFNC025P	866,02
32	DKOF/CP NC	25	DKOFNC032E	925,15	DKOFNC032F	1.017,16	DKOFNC032P	1.054,72
40	DKOF/CP NC	32	DKOFNC040E	1.379,17	DKOFNC040F	1.536,97	DKOFNC040P	1.578,22
50	DKOF/CP NC	40	DKOFNC050E	1.552,76	DKOFNC050F	1.721,37	DKOFNC050P	1.751,91
63	DKOF/CP NC	50	DKOFNC063E	2.120,49	DKOFNC063F	2.406,99	DKOFNC063P	2.402,84
75	DKOF/CP NC	65	DKOFNC075E	2.544,54	DKOFNC075F	2.888,36	DKOFNC075P	2.883,41
90	VMOF/CP NC	80	VMOFNC090E	4.519,93	VMOFNC090F	5.269,05	VMOFNC090P	4.869,12
110	VMOF/CP NC	100	VMOFNC110E	5.684,86	VMOFNC110F	6.398,21	VMOFNC110P	6.252,00

Válvula neumática **NORMALMENTE CERRADA.**

Con bridas DIN.

Disponibles con bridas ANSI 150 libras al mismo precio



DK/CP NO



VM/CP NO

d	Modelo	DN	€		€		€	
			Ref. EPDM	EPDM	Ref. FKM	FKM	Ref. PTFE	PTFE
20	DKOF/CP NO	15	DKOFNO020E	639,42	DKOFNO020F	722,49	DKOFNO020P	752,81
25	DKOF/CP NO	20	DKOFNO025E	670,63	DKOFNO025F	753,58	DKOFNO025P	785,51
32	DKOF/CP NO	25	DKOFNO032E	990,27	DKOFNO032F	1.132,18	DKOFNO032P	1.173,63
40	DKOF/CP NO	32	DKOFNO040E	1.233,99	DKOFNO040F	1.434,87	DKOFNO040P	1.485,81
50	DKOF/CP NO	40	DKOFNO050E	1.400,06	DKOFNO050F	1.620,19	DKOFNO050P	1.680,37
63	DKOF/CP NO	50	DKOFNO063E	1.834,98	DKOFNO063F	2.199,10	DKOFNO063P	2.193,83
75	DKOF/CP NO	65	DKOFNO075E	2.201,96	DKOFNO075F	2.638,91	DKOFNO075P	2.632,61
90	VMOF/CP NO	80	VMOFNO090E	4.057,41	VMOFNO090F	4.929,17	VMOFNO090P	4.462,45
110	VMOF/CP NO	100	VMOFNO110E	5.103,06	VMOFNO110F	5.445,30	VMOFNO110P	5.729,79

Válvula neumática **NORMALMENTE ABIERTA.**

Con bridas DIN.

Disponibles con bridas ANSI 150 libras al mismo precio



DK/CP DE



VM/CP DE

d	Modelo	DN	€		€		€	
			Ref. EPDM	EPDM	Ref. FKM	FKM	Ref. PTFE	PTFE
20	DKOF/CP DE	15	DKOFDA020E	558,96	DKOFDA020F	641,98	DKOFDA020P	672,31
25	DKOF/CP DE	20	DKOFDA025E	590,12	DKOFDA025F	673,08	DKOFDA025P	705,01
32	DKOF/CP DE	25	DKOFDA032E	893,89	DKOFDA032F	1.026,70	DKOFDA032P	1.065,82
40	DKOF/CP DE	32	DKOFDA040E	1.121,80	DKOFDA040F	1.304,42	DKOFDA040P	1.350,72
50	DKOF/CP DE	40	DKOFDA050E	1.088,72	DKOFDA050F	1.099,88	DKOFDA050P	1.111,04
63	DKOF/CP DE	50	DKOFDA063E	1.089,96	DKOFDA063F	1.101,12	DKOFDA063P	1.112,28
75	DKOF/CP DE	65	DKOFDA075E	1.091,20	DKOFDA075F	1.102,36	DKOFDA075P	1.113,52
90	VMOF/CP DE	80	VMOFDA090E	4.428,02	VMOFDA090F	5.299,74	VMOFDA090P	4.833,02
110	VMOF/CP DE	100	VMOFDA110E	5.569,26	VMOFDA110F	5.854,71	VMOFDA110P	6.205,63

Válvula neumática **DOBLE EFECTO.**

Con bridas DIN.

Disponibles con bridas ANSI 150 libras al mismo precio

Consultar precios

CMDF/CP NC *M-M para fusión socket*
CMIF/CP NC *H-H para fusión socket*
CMUIF/CP NC *H-H enlaces fusión socket*
CMFF/CP NC *H-H roscar*



d-Rh	Ref. EPDM	DN	EPDM	FKM	PTFE
20	CMDFNC020E	15	315,42	339,88	347,32
16	CMIFNC016E	12	253,46	289,17	300,45
20	CMIFNC020E	15	274,13	307,97	321,13
20	CMUIFNC020E	15	371,68	407,45	420,60
3/8"	CMFFNC038E	12	257,24	287,30	300,45
1/2"	CMFFNC012E	15	274,13	307,97	321,13

Válvula de membrana compacta neumática
NORMALMENTE CERRADA

Código en FKM termina en "F" en lugar de "E"
 Código en PTFE termina en "P" en lugar de "E"
 (A) = Juntas en FKM

CMDF/CP NO *M-M para fusión socket*
CMIF/CP NO *H-H para fusión socket*
CMUIF/CP NO *H-H enlaces fusión socket*
CMFF/CP NO *H-H roscar*



d-Rh	Ref. EPDM	DN	EPDM	FKM	PTFE
20	CMDFNO020E	15	309,85	336,14	341,73
16	CMIFNO016E	12	247,90	287,30	296,72
20	CMIFNO020E	15	268,52	306,15	317,43
20	CMUIFNO020E	15	369,90	405,54	416,82
3/8"	CMFFNO038E	12	253,46	285,44	296,72
1/2"	CMFFNO012E	15	268,52	306,15	317,43

Válvula de membrana compacta neumática
NORMALMENTE ABIERTA

Código en FKM termina en "F" en lugar de "E"
 Código en PTFE termina en "P" en lugar de "E"
 (A) = Juntas en FKM

CMDF/CP DE *M-M para fusión socket*
CMIF/CP DE *H-H para fusión socket*
CMUIF/CP DE *H-H enlaces fusión socket*
CMFF/CP DE *H-H roscar*



d-Rh	Ref. EPDM	DN	EPDM	FKM	PTFE
20	CMDFDA020E	15	309,85	336,14	341,73
16	CMIFDA016E	12	247,90	287,30	296,72
20	CMIFDA020E	15	268,52	306,15	317,43
20	CMUIFDA020E	15	369,90	405,54	416,82
3/8"	CMFFDA038E	12	253,46	285,44	296,72
1/2"	CMFFDA012E	15	268,52	306,15	317,43

Válvula de membrana compacta neumática
DOBLE EFECTO

Código en FKM termina en "F" en lugar de "E"
 Código en PTFE termina en "P" en lugar de "E"
 (A) = Juntas en FKM



INDUSTRIA

Sistema PVDF

Válvulas de control de presión



Consultar precios



VSF

d	Ref. EPDM	DN	PN	€ PTFE
16	VSFBF016P	10	10	2.039,48
20	VSFBF020P	15	10	2.083,12
25	VSFBF025P	20	10	2.784,97
32	VSFBF032P	25	10	3.296,88
40	VSFBF040P	32	10	5.044,94
50	VSFBF050P	40	10	6.056,40
63	VSFBF063P	50	10	6.471,52

Válvula de sobrepresión-alivio. [Rango de calibración: 0,5 - 10 bars](#)
M-M para soldadura a testa.



VCP

d	Ref. EPDM	DN	PN	€ PTFE
16	VCPBF016P	10	10	1.804,18
20	VCPBF020P	15	10	1.826,14
25	VCPBF025P	20	10	2.530,56
32	VCPBF032P	25	10	2.827,61
40	VCPBF040P	32	10	4.333,73
50	VCPBF050P	40	10	5.624,47
63	VCPBF063P	50	10	5.624,47

Válvula retenedora de presión. [Rango de calibración: 0,5 - 10 bars](#)
M-M para soldadura a testa.



VPR

d	Ref. EPDM	DN	PN	€ PTFE
16	VPRBF016F	10	10	2.157,06
20	VPRBF020F	15	10	2.314,13
25	VPRBF025F	20	10	3.219,37
32	VPRBF032F	25	10	3.655,88
40	VPRBF040F	32	10	3.989,32
50	VPRBF050F	40	10	4.299,46
63	VPRBF063F	50	10	14.527,12

Válvula reductora de presión. [Rango de calibración: 0,5 - 9 bars](#)
M-M para soldadura a testa.



VPR

d	Ref. EPDM	DN	PN	€ PTFE
16	VPRDF016E	10	10	1.165,60
20	VPRDF020E	15	10	1.166,84
25	VPRDF025E	20	10	1.168,08
32	VPRDF032E	25	10	1.169,32
40	VPRDF040E	32	10	1.170,56
50	VPRDF050E	40	10	1.171,80
63	VPRDF063E	50	10	1.173,04

Válvula reductora de presión. [Rango de calibración: 0,5 - 9 bars](#)
M-M para fusión socket.



INDUSTRIA

Sistema PVDF

Conectores



Consultar precios



MANGUITO

d	Ref. EPDM	Para válvulas	€
16	ENDIF016	VKD-VKR-SR	43,52
20	ENDIF020	VKD-VKR-SR	43,52
25	ENDIF025	VKD-VKR-SR	56,68
32	ENDIF032	VKD-VKR-SR	76,17
40	ENDIF040	VKD-VKR-SR	99,07
50	ENDIF050	VKD-VKR-SR	117,27
63	ENDIF063	VKD-VKR-SR	178,81
75	ENDIF075	VKD	380,69
90	ENDIF090	VKD	596,78
110	ENDIF110	VKD	1.054,31

Conector final en PVDF.

H para soldar socket.

MANGUITO

d	Ref. EPDM	Para válvulas	€
20	ENDDF020	VKD-VKR-SR	43,52
25	ENDDF025	VKD-VKR-SR	56,68
32	ENDDF032	VKD-VKR-SR	76,17
40	ENDDF040	VKD-VKR-SR	99,07
50	ENDDF050	VKD-VKR-SR	117,27
63	ENDDF063	VKD-VKR-SR	178,81
75	ENDDF075	VKD	380,69
90	ENDDF090	VKD	596,78
110	ENDDF110	VKD	1.054,31

Conector final en PVDF.

M para soldar socket.

MANGUITO

Rh	Ref. EPDM	Para válvulas	€
½"	ENDFF012	VKD-VKR-SR	43,52
¾"	ENDFF034	VKD-VKR-SR	56,68
1"	ENDFF100	VKD-VKR-SR	76,17
1¼"	ENDFF114	VKD-VKR-SR	99,07
1½"	ENDFF112	VKD-VKR-SR	117,27
2"	ENDFF200	VKD-VKR-SR	178,81

Conector final en PVDF.

H rosca GAS.

CVDF

d	Ref. EPDM	Para válvulas	€
20	CVDF21020	VKD-VKR-SR	34,54
25	CVDF21025	VKD-VKR-SR	43,21
32	CVDF21032	VKD-VKR-SR	46,30
40	CVDF21040	VKD-VKR-SR	57,68
50	CVDF21050	VKD-VKR-SR	85,21
63	CVDF21063	VKD-VKR-SR	115,15
75	CVDF21075	VKD	314,51
90	CVDF21090	VKD	396,04
110	CVDF21110	VKD	577,32

Conector final en PVDF SDR21 PN16.

Para soldar a testa o electrofusión.

CVDF

d	Ref. EPDM	Para válvulas	€
20	QBBFL21020	CM-DK	43,96
25	QBBFL21025	CM-DK	39,95
32	QBBFL21032	CM-DK	58,92
40	QBBFL21040	CM-DK	73,42
50	QBBFL21050	CM-DK	108,44
63	QBBFL21063	CM-DK	146,55

Conector final en PVDF SDR21 PN16.

Para soldar a testa o electrofusión.

MANGUITO

Rh	Ref. EPDM	Para válvulas	€
½"	ENDNF012	VKD-VKR-SR	44,63
¾"	ENDNF034	VKD-VKR-SR	56,68
1"	ENDNF100	VKD-VKR-SR	76,17
1¼"	ENDNF114	VKD-VKR-SR	99,07
1½"	ENDNF112	VKD-VKR-SR	117,27
2"	ENDNF200	VKD-VKR-SR	178,81

Conector final en PVDF.

H rosca NPT.

Tubo y accesorios
Válvulas manuales
Válvulas actuadas



0806

Sistema C-PVC

INDUSTRIA



Más información





Sistema C-PVC





INDUSTRIA

Sistema C-PVC

Tubo y accesorios



GIC

d	Ref.	PN	€/m.
16	PIPEC13016	16	4,41
20	PIPEC13020	16	6,49
25	PIPEC13025	16	10,20
32	PIPEC13032	16	16,48
40	PIPEC13040	16	25,37
50	PIPEC13050	16	38,71
63	PIPEC13063	16	61,93
75	PIPEC13075	16	87,70
90	PIPEC13090	16	124,61
110	PIPEC13110	16	186,51
110	PIPEC21110	10	113,71
160	PIPEC13160	16	323,90
160	PIPEC21160	10	294,22
225	PIPEC21225	10	805,72

Tubo en C-PVC SDR 13,5

Barras de 5 m.

d	Ref.	Pack	€
16	GIC016	10	4,41
20	GIC020	10	4,94
25	GIC025	10	6,21
32	GIC032	10	7,40
40	GIC040	10	9,66
50	GIC050	5	16,87
63	GIC063	2	21,01
75	GIC075	-	40,10
90	GIC090	-	53,75
110	GIC110	-	98,57
160	GIC160	-	246,36
225*	GIC225	-	1.226,76

Codo 90°.

* PN10

H-H encolar.

HIC



d	Ref.	Pack	€
20	HIC020	10	5,92
25	HIC025	10	8,29
32	HIC032	10	10,09
40	HIC040	5	14,55
50	HIC050	5	23,31
63	HIC063	5	35,62
75	HIC075	-	54,85
90	HIC090	-	81,25
110	HIC110	-	132,39
160	HIC160	-	284,67
225*	HIC225	-	932,72

Codo 45°

* PN10

H-H encolar.

TIC



d	Ref.	Pack	€
16	TIC016	10	4,58
20	TIC020	10	5,51
25	TIC025	10	6,85
32	TIC032	10	8,29
40	TIC040	5	11,41
50	TIC050	5	19,19
63	TIC063	2	26,01
75	TIC075	-	53,75
90	TIC090	-	77,49
110	TIC110	-	119,58
160	TIC160	-	370,49
225*	TIC225	-	1.453,77

Te a 90°.

* PN10

H-H-H encolar.



TRIC

d x dr	Ref.	Pack	€
25 x 20	TRIC025020	10	5,92
32 x 20	TRIC032020	10	10,09
32 x 25	TRIC032025	10	10,09
40 x 20	TRIC040020	10	14,16
40 x 25	TRIC040025	10	14,16
50 x 25	TRIC050025	10	23,31
50 x 32	TRIC050032	10	23,31
63 x 25	TRIC063025	5	33,81
63 x 32	TRIC063032	5	33,81
75 x 25	TRIC075025	-	65,08
90 x 25	TRIC090025	-	80,99
110 x 25	TRIC110025	-	103,88

Te a 90° reducida.

H-H-H encolar.



TIMC

d x Rh	Ref.	Pack	€
16 x 3/8"	TIMC016038	10	10,09
20 x 1/2"	TIMC020012	10	10,97
25 x 3/4"	TIMC025034	10	11,41
32 x 1"	TIMC032100	10	14,16
40 x 1 1/4"	TIMC040114	10	17,23
50 x 1 1/2"	TIMC050112	10	26,42
63 x 2"	TIMC063200	5	32,91

Te a 90° mixta reforzada inox.

H-H-H encolar-rosca.



MIMC

d x Rh	Ref.	Pack	€
16 x 3/8"	MIMC016038	10	6,49
20 x 1/2"	MIMC020012	10	6,85
25 x 3/4"	MIMC025034	10	7,73
32 x 1"	MIMC032100	10	9,61
40 x 1 1/4"	MIMC040114	5	13,21
50 x 1 1/2"	MIMC050112	5	17,23
63 x 2"	MIMC063200	5	22,85

Manguito mixto reforzado inox.

H-H encolar-rosca.



MIC

d	Ref.	Pack	€
16	MIC016	10	3,19
20	MIC020	10	3,69
25	MIC025	10	4,12
32	MIC032	10	5,05
40	MIC040	5	5,51
50	MIC050	5	9,17
63	MIC063	2	14,16
75	MIC075	-	21,01
90	MIC090	-	35,62
110	MIC110	-	64,79
160	MIC160	-	151,41
225*	MIC225	-	676,43

Manguito.

H-H encolar.

* PN10



GIMC

d x Rh	Ref.	Pack	€
16 x 3/8"	GIMC016038	10	6,70
20 x 1/2"	GIMC020012	10	8,01
25 x 3/4"	GIMC025034	10	9,17
32 x 1"	GIMC032100	10	13,21
40 x 1 1/4"	GIMC040114	10	16,38
50 x 1 1/2"	GIMC050112	10	23,69
63 x 2"	GIMC063200	5	32,03

Codo a 90° mixto reforzado inox.

H-H encolar-rosca.



KIFC

dm x dh x Rm	Ref.	Pack	€
20 x 16 x 3/8"	KIFC20016038	10	5,51
25 x 20 x 1/2"	KIFC25020012	10	6,44
32 x 25 x 3/4"	KIFC32025034	10	6,85
40 x 32 x 1"	KIFC40032100	10	8,29
50 x 40 x 1 1/4"	KIFC50040114	5	10,09
63 x 50 x 1 1/2"	KIFC63050112	5	11,88
75 x 63 x 2"	KIFC75063200	-	20,14

Terminal rosca macho.

M-H encolar - M rosca

DIC



d x dr	Ref.	Pack	€
20 x 16	DIC020016	10	3,81
25 x 20	DIC025020	10	4,41
32 x 20	DIC032020	10	5,13
32 x 25	DIC032025	10	5,13
40 x 20	DIC040020	10	8,29
40 x 25	DIC040025	10	8,29
40 x 32	DIC040032	10	8,29
50 x 32	DIC050032	10	8,53
50 x 40	DIC050040	10	8,53
63 x 32	DIC063032	5	13,58
63 x 40	DIC063040	5	13,58
63 x 50	DIC063050	5	13,58
75 x 50	DIC075050	5	21,53
75 x 63	DIC075063	-	21,53
90 x 50	DIC090050	-	30,06
90 x 63	DIC090063	-	30,06
90 x 75	DIC090075	-	30,06
110 x 63	DIC110063	-	46,17
110 x 75	DIC110075	-	46,17
110 x 90	DIC110090	-	46,17
160 x 110	DIC160110	-	114,02
225 x 160*	DIC225160	-	466,78

Casquillo reducción. * PN10
M-H encolar.

CIC



d	Ref.	Pack	€
20	CIC020	10	3,71
25	CIC025	10	6,00
32	CIC032	10	7,86
40	CIC040	10	10,43
50	CIC050	10	16,63
63	CIC063	5	19,19
75	CIC075	-	30,33
90	CIC090	-	43,24
110	CIC110	-	58,09

Tapón hembra.
H encolar.



Ref.	Producto	€
TG724	1) Cola TEMPERGLUE 724	58,43
PCP70	1) Decapante Primer Cleaner P70	24,62
TGBISON	2) Cola TEMPERGLUE 100	58,43
PCBISON	2) Decapante TEMPERFIP 100	24,62

Cola y decapante. 1) TEMPERGLUE 724 debe utilizarse con PRIMER CLEANER P70. Cola especialmente recomendada para la unión de piezas de C-PVC en contacto con fluidos químicamente agresivos (como ácidos y bases). 2) TEMPERGLUE 100 debe utilizarse con TEMPERFIP 100.

QRC



d	Ref.	DN	Pack	€
20	QRC020	15	10	5,95
25	QRC025	20	10	7,31
32	QRC032	25	10	8,70
40	QRC040	32	5	10,09
50	QRC050	40	5	10,54
63	QRC063	50	2	12,75
75	QRC075	65	-	19,19
90	QRC090	80	-	28,22
110	QRC110	100	-	43,83
160	QRC160	150	-	151,41
225*	QRC225	200	-	584,76

Manguito portabridas. * PN10
H encolar. Para usar con brida ODC.

ODC



d	Ref.	DN	Pack	€
20	ODC020	15	2	7,31
25	ODC025	20	2	8,70
32	ODC032	25	2	10,09
40	ODC040	32	2	12,34
50	ODC050	40	2	15,94
63	ODC063	50	2	17,75
75	ODC075	65	2	26,42
90	ODC090	80	2	29,20
110	ODC110	100	2	40,10

Brida loca.
UNI 2223 PN10/16. Para usar con portabridas QRC.

ODB



d	Ref.	DN	€
20	ODB020	15	8,85
25	ODB025	20	9,72
32	ODB032	25	12,51
40	ODB040	32	15,18
50	ODB050	40	17,75
63	ODB063	50	22,08
75	ODB075	65	24,40
90	ODB090	80	29,06
125	ODB125	100	35,07

Brida loca. Más diámetros en página 320.
En PP con alma de acero.
PN10. Para manguito portabridas.
Versión ANSI 150 lbs (ver OAB página 320).
Descuento de la familia PP-H.



INDUSTRIA

Sistema C-PVC

Uniones 3 piezas



BIC



d	Ref. EPDM	Pack	€ EPDM	€ FKM
16	BIC016E	10	16,38	-
20	BIC020E	10	18,31	-
25	BIC025E	10	19,72	-
32	BIC032E	10	23,69	-
40	BIC040E	10	32,03	-
50	BIC050E	10	44,29	-
63	BIC063E	2	62,93	-

Unión 3 piezas.

Junta en EPDM ó FKM.
H-H encolar.Código en FKM termina en "F"
en lugar de "E"

BIFC



d x Rh	Ref.	Pack	€ EPDM
16 x 3/8"	BIFC016038E	10	26,42
20 x 1/2"	BIFC020012E	10	29,20
25 x 3/4"	BIFC025034E	10	31,09
32 x 1"	BIFC032100E	2	34,69
40 x 1 1/4"	BIFC040114E	2	56,68
50 x 1 1/2"	BIFC050112E	2	81,25
63 x 2"	BIFC063200E	2	91,36

Unión 3 piezas mixto.

Junta en EPDM
H-H encolar-roskar.

BIFOC



d x Rh	Ref.	Pack	Pack	U/	€ EPDM
16 x 3/8"	BIFOC016038E	16	50	100	33,97
20 x 1/2"	BIFOC020012E	16	40	80	40,79
25 x 3/4"	BIFOC025034E	16	20	40	53,77
32 x 1"	BIFOC032100E	16	14	28	63,50
40 x 1 1/4"	BIFOC040114E	16	8	16	88,66
50 x 1 1/2"	BIFOC050112E	16	4	8	108,39
63 x 2"	BIFOC063200E	16	-	12	141,96

Unión 3 piezas mixto C-PVC / Latón.

Junta en EPDM.
H-M encolar-roskar latón.

BIROC



d x Rm	Ref.	Pack	Pack	U/	€ EPDM
16 x 3/8"	BIROC016038E	16	50	100	36,93
20 x 1/2"	BIROC020012E	16	35	70	44,70
25 x 3/4"	BIROC025034E	16	15	30	56,50
32 x 1"	BIROC032100E	16	12	24	73,26
40 x 1 1/4"	BIROC040114E	16	8	16	104,13
50 x 1 1/2"	BIROC050112E	16	4	8	127,60
63 x 2"	BIROC063200E	16	-	10	160,76

Unión 3 piezas mixto C-PVC / Latón.

Junta en EPDM.
H-M encolar-roskar latón.



INDUSTRIA

Sistema C-PVC

Válvulas de bola



VKDIC

d	Ref. EPDM	DN	PN	€ EPDM	€ FKM
16	VKDIC016E	10	16	97,62	126,84
20	VKDIC020E	15	16	97,62	126,84
25	VKDIC025E	20	16	105,91	136,97
32	VKDIC032E	25	16	126,84	154,29
40	VKDIC040E	32	16	147,75	174,22
50	VKDIC050E	40	16	179,20	219,94
63	VKDIC063E	50	16	226,58	284,67

Válvula de bola DUAL BLOCK®
Asiento PTFE (teflón). Bidireccional.
H-H encolar.

Código en FKM termina en "F"
en lugar de "E"



VKDOC

d	Ref. EPDM	DN	PN	€ EPDM	€ FKM
20	VKDOC020E	15	16	207,08	254,70
25	VKDOC025E	20	16	218,91	264,02
32	VKDOC032E	25	16	248,02	288,17
40	VKDOC040E	32	16	340,05	378,58
50	VKDOC050E	40	16	394,52	448,85
63	VKDOC063E	50	16	464,61	548,15

Válvula de bola DUAL BLOCK®
Asiento PTFE (teflón). Bidireccional.
Con brida loca.

Código en FKM termina en "F"
en lugar de "E"
Versión con bridas ANSI 150 lbs
al mismo precio



VKDIC

d	Ref. EPDM	DN	PN	€ EPDM	€ FKM
75	VKDIC075E	65	16	663,87	858,61
90	VKDIC090E	80	16	870,97	1.101,33
110	VKDIC110E	100	16	1.050,86	1.281,25

Válvula de bola DUAL BLOCK®
Asiento PTFE (teflón). Bidireccional.
H-H encolar.

Código en FKM termina en "F"
en lugar de "E"



VKDOC

d	Ref. EPDM	DN	PN	€ EPDM	€ FKM
75	VKDOC075E	65	16	995,75	1.190,53
90	VKDOC090E	80	16	1.306,50	1.536,86
110	VKDOC110E	100	16	1.576,29	1.806,65

Válvula de bola DUAL BLOCK®
Asiento PTFE (teflón). Bidireccional.
Con brida loca DIN y ANSI.

Código en FKM termina en "F"
en lugar de "E"



VKDDC

d	Ref. EPDM	DN	PN	€ EPDM	€ FKM
20	VKDDC020E	15	16	112,22	141,52
25	VKDDC025E	20	16	121,42	144,20
32	VKDDC032E	25	16	146,00	175,03
40	VKDDC040E	32	16	169,72	196,19
50	VKDDC050E	40	16	196,19	245,48
63	VKDDC063E	50	16	254,87	316,67

Válvula de bola DUAL BLOCK®
Asiento PTFE (teflón). Bidireccional.
M-M encolar.

Código en FKM termina en "F"
en lugar de "E"



VXEIC

d	Ref. EPDM	DN	PN	U/	€ EPDM	€ FKM
16	VXEIC016E	10	16	100	60,72	78,81
20	VXEIC020E	15	16	80	60,72	78,81
25	VXEIC025E	20	16	40	65,71	85,02
32	VXEIC032E	25	16	28	74,29	90,50
40	VXEIC040E	32	16	16	90,41	106,66
50	VXEIC050E	40	16	8	104,65	128,52
63	VXEIC063E	50	16	12	141,52	178,06

Válvula de bola maneta naranja.
Asiento PTFE (teflón). Bidireccional.
H-H encolar.

Código en FKM termina en "F"
en lugar de "E"

Disponemos de manguitos
roscados para estas válvulas



VKDDC

d	Ref. EPDM	DN	PN	€ EPDM	€ FKM
75	VKDDC075E	65	16	730,20	925,02
90	VKDDC090E	80	16	958,11	1.188,52
110	VKDDC110E	100	16	1.155,92	1.386,31

Válvula de bola DUAL BLOCK®
Asiento PTFE (teflón). Bidireccional.
M-M encolar.

Código en FKM termina en "F"
en lugar de "E"



VXEIC

d	Ref. EPDM	DN	PN	€ EPDM	€ FKM
75	VXEIC075E	65	16	435,72	515,16
90	VXEIC090E	80	16	562,95	659,29
110	VXEIC110E	100	16	792,59	947,74

Válvula de bola maneta naranja.
Asiento PTFE (teflón). Bidireccional.
H-H encolar.

Código en FKM termina en "F"
en lugar de "E"

Disponemos de manguitos
roscados para estas válvulas



TKDIC

d	Ref. EPDM	DN	PN	€ EPDM	€ FKM
16	TKDIC016E	10	16	185,50	200,78
20	TKDIC020E	15	16	185,50	200,78
25	TKDIC025E	20	16	201,24	221,55
32	TKDIC032E	25	16	240,90	266,13
40	TKDIC040E	32	16	298,16	334,65
50	TKDIC050E	40	16	331,59	392,87
63	TKDIC063E	50	16	421,71	499,09

Válvula de bola 3 vías
DUAL BLOCK®. PASO T.
Asiento PTFE (teflón). H-H-H encolar.

Código en FKM termina en "F"
en lugar de "E"

Disponemos de manguitos
roscados para estas válvulas



LKDIC

d	Ref. EPDM	DN	PN	€ EPDM	€ FKM
16	LKDIC016E	10	16	213,34	228,59
20	LKDIC020E	15	16	213,34	228,59
25	LKDIC025E	20	16	231,42	251,76
32	LKDIC032E	25	16	277,00	302,31
40	LKDIC040E	32	16	342,87	379,38
50	LKDIC050E	40	16	381,25	442,62
63	LKDIC063E	50	16	485,01	562,38

Válvula de bola 3 vías
DUAL BLOCK®. PASO L.
Asiento PTFE (teflón). H-H-H encolar.

Código en FKM termina en "F"
en lugar de "E"

Disponemos de manguitos
roscados para estas válvulas



INDUSTRIA

Sistema C-PVC

Válvulas de mariposa



FKOC/FM

d	Ref. EPDM	DN	€ EPDM	€ FKM
50	FKOCFM050E	40	347,50	515,05
63	FKOCFM063E	50	367,98	545,29
75	FKOCFM075E	65	408,86	605,93
90	FKOCFM090E	80	444,43	650,38
110	FKOCFM110E	100	482,92	696,28
125	FKOCFM140E	125	641,47	931,81
140	FKOCFM140E	125	641,47	931,81
160	FKOCFM160E	150	708,14	997,04
200	FKOCFM225E	200	916,99	1.293,29
225	FKOCFM225E	200	916,99	1.293,29
250**	FKOCFM280E	250	2.921,69	4.649,20
280**	FKOCFM280E	250	2.921,69	4.649,20
315**	FKOCFM315E	300	3.185,50	5.070,03

Válvula de mariposa industrial.

A EJE LIBRE.

Para actuar. Cuerpo en PPGR,
eje inoxidable y disco en C-PVC.

Código en FKM termina en "F"
en lugar de "E"

** ANSI 150 lbs bajo pedido
al mismo precio.



FKOC/RM

d	Ref. EPDM	DN	€ EPDM	€ FKM
75	FKOCRM075E	65	1.076,99	1.269,54
90	FKOCRM090E	80	1.099,20	1.300,65
110	FKOCRM110E	100	1.145,14	1.351,04
125	FKOCRM140E	125	1.324,36	1.608,78
140	FKOCRM140E	125	1.324,36	1.608,78
160	FKOCRM160E	150	1.382,18	1.645,75
200	FKOCRM225E	200	1.749,58	2.091,74
225	FKOCRM225E	200	1.749,58	2.091,74
250**	FKOCRM280E	250	3.345,47	5.073,02
280**	FKOCRM280E	250	3.345,47	5.073,02
315**	FKOCRM315E	300	3.609,17	5.493,75

Válvula de mariposa industrial.

CON VOLANTE.

Cuerpo en PPGR,
eje inoxidable y disco en C-PVC.

Código en FKM termina en "F"
en lugar de "E"

** ANSI 150 lbs bajo pedido
al mismo precio.



FKOC/LM

d	Ref. EPDM	DN	€ EPDM	€ FKM
50	FKOCLM050E	40	408,01	571,68
63	FKOCLM063E	50	431,96	605,32
75	FKOCLM075E	65	479,95	672,56
90	FKOCLM090E	80	505,15	706,61
110	FKOCLM110E	100	548,15	755,52
125	FKOCLM140E	125	728,87	1.013,28
140	FKOCLM140E	125	728,87	1.013,28
160	FKOCLM160E	150	786,63	1.050,33
200	FKOCLM225E	200	1.017,69	1.361,39
225	FKOCLM225E	200	1.017,69	1.361,39

Válvula de mariposa industrial.

CON MANETA.

Cuerpo en PPGR,
eje inoxidable y disco en C-PVC.

Código en FKM termina en "F"
en lugar de "E"

FKOC/FM

d	Ref. EPDM	DN	€ EPDM	€ FKM
75	FKOLCFM075E	65	601,28	801,27
90	FKOLCFM090E	80	694,54	903,47
110	FKOLCFM110E	100	754,58	971,11
125	FKOLCFM140E	125	1.004,14	1.298,80
140	FKOLCFM140E	125	1.004,14	1.298,80
160	FKOLCFM160E	150	1.100,38	1.393,52
200	FKOLCFM225E	200	1.325,88	1.707,68
225	FKOLCFM225E	200	1.325,88	1.707,68

Válvula de mariposa industrial.

A EJE LIBRE. LUG ISO-DIN.

Para actuar. Cuerpo en PPGR,
eje inoxidable y disco en C-PVC.

Código en FKM termina en "F"
en lugar de "E"



FKOC/LM

d	Ref. EPDM	DN	€ EPDM	€ FKM
75	FKOLCLM075E	65	663,71	856,22
90	FKOLCLM090E	80	745,11	946,60
110	FKOLCLM110E	100	808,84	1.016,24
125	FKOLCLM140E	125	1.076,99	1.361,39
140	FKOLCLM140E	125	1.076,99	1.361,39
160	FKOLCLM160E	150	1.162,95	1.426,63
200	FKOLCLM225E	200	1.407,27	1.750,97
225	FKOLCLM225E	200	1.407,27	1.750,97

Válvula de mariposa industrial.

CON MANETA. LUG ISO-DIN.

Cuerpo en PPGR,

eje inoxidable y disco en C-PVC.

Código en FKM termina en "F"
en lugar de "E"



FKOC/RM

d	Ref. EPDM	DN	€ EPDM	€ FKM
75	FKOLCRM075E	65	1.260,64	1.453,20
90	FKOLCRM090E	80	1.339,19	1.540,61
110	FKOLCRM110E	100	1.405,87	1.611,76
125	FKOLCRM140E	125	1.672,45	1.956,90
140	FKOLCRM140E	125	1.672,45	1.956,90
160	FKOLCRM160E	150	1.758,43	2.022,08
200	FKOLCRM225E	200	2.139,12	2.481,30
225	FKOLCRM225E	200	2.139,12	2.481,30

Válvula de mariposa industrial.

CON VOLANTE. LUG ISO-DIN.

Cuerpo en PPGR,

eje inoxidable y disco en C-PVC.

Código en FKM termina en "F"
en lugar de "E"



FKOC/RM

d	Ref. EPDM	DN	€ EPDM	€ FKM
2½"	FKOALCRM212E	65	1.352,47	1.545,13
3"	FKOALCRM300E	80	1.435,45	1.636,91
4"	FKOALCRM400E	100	1.511,04	1.716,93
5"	FKOALCRM500E	125	1.811,74	2.096,15
6"	FKOALCRM600E	150	1.909,52	2.173,20
8"	FKOALCRM800E	200	2.333,14	2.675,36
10"	FKOALCRM810E	250	5.213,20	6.940,72
12"	FKOALCRM812E	300	5.519,69	7.404,28

Válvula de mariposa industrial.

CON VOLANTE. LUG ANSI.

Cuerpo en PPGR, eje inoxidable
y disco en C-PVC.

Código en FKM termina en "F"
en lugar de "E"



FKOC/LM

d	Ref. EPDM	DN	€ EPDM	€ FKM
2½"	FKOALCLM212E	65	755,52	948,05
3"	FKOALCLM300E	80	841,43	1.042,92
4"	FKOALCLM400E	100	913,98	1.121,40
5"	FKOALCLM500E	125	1.216,21	1.500,68
6"	FKOALCLM600E	150	1.313,99	1.577,72
8"	FKOALCLM800E	200	1.601,31	1.945,01

Válvula de mariposa industrial.

CON MANETA. LUG ANSI.

Cuerpo en PPGR,

eje inoxidable y disco en C-PVC.

Código en FKM termina en "F"
en lugar de "E"



DKDC

d	Ref. EPDM	DN	PN	€		
				EPDM	FKM	PTFE
20	DKDC020E	15	10	140,93	266,90	266,90
25	DKDC025E	20	10	157,98	291,37	291,37
32	DKDC032E	25	10	184,30	312,09	312,09
40	DKDC040E	32	10	220,06	413,58	413,58
50	DKDC050E	40	10	282,07	473,73	473,73
63	DKDC063E	50	10	336,53	654,20	654,20
75	DKDC075E	65	10	403,84	785,05	785,05

Válvula de membrana
DIALOCK®.

M-M encolar.

Código en FKM termina en "F"
en lugar de "E"
Código en PTFE termina en "P"
en lugar de "E"



DKOC

d	Ref. EPDM	DN	PN	€		
				EPDM	FKM	PTFE
20	DKOC020E	15	10	240,90	366,81	366,81
25	DKOC025E	20	10	262,58	395,96	395,96
32	DKOC032E	25	10	293,19	420,96	420,96
40	DKOC040E	32	10	362,95	556,54	556,54
50	DKOC050E	40	10	431,81	623,51	623,51
63	DKOC063E	50	10	543,27	860,90	860,90
75	DKOC075E	65	10	706,27	1.119,18	1.119,18

Válvula de membrana

© DIALOCK .

Con bridas DIN.

Código en FKM termina en "F"
en lugar de "E"
Código en PTFE termina en "P"
en lugar de "E"



VMDC

d	Ref. EPDM	DN	€		
			EPDM	FKM	PTFE
90	VMDC090E	80	906,07	1.616,69	1.616,69
110	VMDC110E	100	1.282,02	2.518,97	2.518,97

Válvula de membrana

M-M encolar.

Código en FKM termina en "F"
en lugar de "E"
Código en PTFE termina en "P"
en lugar de "E"



VMOC

d	Ref. EPDM	DN	€		
			EPDM	FKM	PTFE
90	VMOC090E	80	1.210,30	1.920,95	1.920,95
110	VMOC110E	100	1.638,68	2.875,66	2.875,66

Válvula de membrana

Con bridas DIN. Bajo pedido
con bridas ANSI 150 lbs
al mismo precio

Código en FKM termina en "F"
en lugar de "E"
Código en PTFE termina en "P"
en lugar de "E"



DKUIC

d	Ref. EPDM	DN	PN	€		
				EPDM	FKM	PTFE
20	DKUIC020E	15	10	159,80	285,77	285,77
25	DKUIC025E	20	10	178,60	312,09	312,09
32	DKUIC032E	25	10	206,85	334,65	334,65
40	DKUIC040E	32	10	255,63	449,29	449,29
50	DKUIC050E	40	10	319,69	511,32	511,32
63	DKUIC063E	50	10	394,83	712,48	712,48

Válvula de membrana
DIALOCK®.

Con enlaces H-H para encolar.

Código en FKM termina en "F"
en lugar de "E"
Código en PTFE termina en "P"
en lugar de "E"



DKUFC

Rh	Ref. EPDM	DN	PN	€ EPDM	€ FKM	€ PTFE
½"	DKUFC012E	15	10	168,15	301,84	301,84
¾"	DKUFC034E	20	10	193,69	330,58	330,58
1"	DKUFC100E	25	10	221,07	346,70	346,70
1¼"	DKUFC114E	32	10	302,15	496,20	496,20
1½"	DKUFC112E	40	10	369,39	558,93	558,93
2"	DKUFC200E	50	10	442,18	761,17	761,17

Válvula de membrana
DIALOCK®.
Con enlaces H-H para roscar.

Código en FKM termina en "F"
en lugar de "E"
Código en PTFE termina en "P"
en lugar de "E"



DKOAC

d	Ref. EPDM	DN	PN	€ EPDM	€ FKM	€ PTFE
½"	DKOAC012E	15	10	240,90	366,81	366,81
¾"	DKOAC034E	20	10	262,58	395,96	395,96
1"	DKOAC100E	25	10	293,19	420,96	420,96
1¼"	DKOAC114E	32	10	362,95	556,54	556,54
1½"	DKOAC112E	40	10	431,81	623,51	623,51
2"	DKOAC200E	50	10	543,27	860,90	860,90
2½"	DKOAC212E	65	10	706,27	1.119,18	1.119,18

Válvula de membrana
DIALOCK®.
Con bridas ANSI 150 lbs.

Código en FKM termina en "F"
en lugar de "E"
Código en PTFE termina en "P"
en lugar de "E"



RVUIC

d	Ref. EPDM	DN	PN	€ EPDM	€ FKM
20	RVUIC020E	15	16	127,98	147,19
25	RVUIC025E	20	16	138,23	162,05
32	RVUIC032E	25	16	181,83	209,40
40	RVUIC040E	32	16	207,99	259,41
50	RVUIC050E	40	16	263,40	305,99
63	RVUIC063E	50	16	343,61	385,56

Filtro inclinado.
Juntas en EPDM o FKM.
H-H con enlaces para encolar.

Código en FKM termina en "F"
en lugar de "E"



CMDC

M-M encolar

CMUIC

H-H enlaces encolar

d	Ref. EPDM	DN	€ EPDM	€ FKM	€ PTFE
20	CMDC020E	15	195,55	272,59	272,59
20	CMUIC020E	15	225,60	289,53	289,53

Válvula de membrana
compacta

Código en FKM termina en "F"
en lugar de "E"
Código en PTFE termina en "P"
en lugar de "E"



SETFLOC

d DIN	d ANSI	Ref. DIN	€ DIN 2501	€ ANSI
20	½"	SETFLOC020	61,13	61,13
25	¾"	SETFLOC025	70,04	70,04
32	1"	SETFLOC032	83,36	83,36
40	1¼"	SETFLOC040	104,80	104,80
50	1½"	SETFLOC050	113,04	113,04
63	2"	SETFLOC063	143,58	143,58
75	2½"	SETFLOC075	199,72	
90	3"	SETFLOC090	293,63	
110	4"	SETFLOC110	368,53	

Set embrizado.
Compuesto por 1 brida, 1 anillo fijación y 1 tuerca.
Para Válvulas VKD / TKD / RVU.

d. 75-90-110,
es el mismo artículo
para DIN y ANSI



Sistema C-PVC

Válvulas anti-retorno con muelle



SSEIC

d	Ref. EPDM	DN	PN	Pack	U/	€ EPDM	€ FKM
16	SSEIC016E	10	16	2	30	96,03	98,55
20	SSEIC020E	15	16	2	30	96,03	98,55
25	SSEIC025E	20	16	2	30	103,93	104,28
32	SSEIC032E	25	16	2	20	125,15	127,26
40	SSEIC040E	32	16	2	14	142,96	154,48
50	SSEIC050E	40	16	2	6	194,65	206,85
63	SSEIC063E	50	16	2	6	234,41	241,41
75	SSEIC075E	65	16	-	1	650,32	682,35
90	SSEIC090E	80	16	-	1	840,15	876,82
110	SSEIC110E	100	16	-	1	1.577,27	1.654,80

Válvula de retención
con muelle en INOX 316.

Código en FKM termina en "F"
en lugar de "E"

Juntas en EPDM o FKM. H-H encolar.



SSEAC

d	Ref. EPDM	DN	PN	Pack	U/	€ EPDM	€ FKM
1/2"	SSEAC012E	10	16	2	30	96,12	98,60
3/4"	SSEAC034E	15	16	2	30	104,01	106,44
1"	SSEAC100E	20	16	2	30	125,25	127,35
1 1/4"	SSEAC114E	25	16	2	20	143,09	154,58
1 1/2"	SSEAC112E	32	16	2	14	194,78	207,00
2"	SSEAC200E	40	16	2	6	234,57	241,58
2 1/2"	SSEAC212E	50	16	2	6	650,80	682,85
3"	SSEAC300E	65	16	-	1	840,77	877,46
4"	SSEAC400E	80	16	-	1	1.578,43	1.656,01

Válvula de retención
con muelle en INOX 316.
H-H encolar serie ASTM.

Código en FKM termina en "F"
en lugar de "E"

Juntas en EPDM o FKM. H-H encolar.



SSEIC

d	Ref. EPDM	DN	PN	Pack	U/	€ EPDM	€ FKM
16	SSEIC016EH	10	16	2	30	Consultar	Consultar
20	SSEIC020EH	15	16	2	30	Consultar	Consultar
25	SSEIC025EH	20	16	2	30	Consultar	Consultar
32	SSEIC032EH	25	16	2	20	Consultar	Consultar

Válvula de retención
con muelle en HASTELLOY

Código en FKM termina en "F"
en lugar de "E"

Juntas en EPDM o FKM. H-H encolar.



SSEAC

d	Ref. EPDM	DN	PN	Pack	U/	€ EPDM	€ FKM
1/2"	SSEAC012EH	15	16	2	30	Consultar	Consultar
3/4"	SSEAC034EH	20	16	2	30	Consultar	Consultar
1"	SSEAC100EH	25	16	2	30	Consultar	Consultar

Válvula de retención
con muelle en HASTELLOY
H-H encolar serie ASTM.

Código en FKM termina en "F"
en lugar de "E"

Juntas en EPDM o FKM. H-H encolar serie ASTM.



SSEIC

d	Ref. EPDM	DN	PN	Pack	U/	€ EPDM	€ FKM
40	SSEIC040EOP	32	16	2	2	Consultar	Consultar
50	SSEIC050EOP	40	16	2	2	Consultar	Consultar
63	SSEIC063EOP	50	16	2	2	Consultar	Consultar
75	SSEIC075EOP	65	16	-	1	Consultar	Consultar
90	SSEIC090EOP	80	16	-	1	Consultar	Consultar
110	SSEIC110EOP	100	16	-	1	Consultar	Consultar

Válvula de retención con muelle
en INOX recubierto PTFE.

Código en FKM termina en "F"
en lugar de "E"

Juntas en EPDM o FKM. H-H encolar.



SSEAC

d	Ref. EPDM	DN	PN	Pack	U/	€ EPDM	€ FKM
1 1/4"	SSEAC114EOP	32	16	2	2	Consultar	Consultar
1 1/2"	SSEAC112EOP	40	16	2	2	Consultar	Consultar
2"	SSEAC200EOP	50	16	2	2	Consultar	Consultar
2 1/2"	SSEAC212EOP	65	16	-	1	Consultar	Consultar
3"	SSEAC300EOP	80	16	-	1	Consultar	Consultar
4"	SSEAC400EOP	100	16	-	1	Consultar	Consultar

Válvula de retención con muelle
en INOX recubierto PTFE.

Código en FKM termina en "F"
en lugar de "E"

Juntas en EPDM o FKM. H-H encolar serie ASTM.



INDUSTRIA

Sistema C-PVC

Válvulas de bola actuadas



VKDIC/CE

Encolar



ACTUACIÓN ELÉCTRICA

ACTUACIÓN ELÉCTRICA CON BLOQUE DE SEGURIDAD

d	24-240 V AC/DC		24-240 V AC/DC		24-240 V AC/DC		24-240 V AC/DC	
	Ref.	€	Ref.	€	Ref.	€	Ref.	€
		EPDM		FKM		EPDM		FKM
16	VKCE016E2D	683,51	VKCE016F2D	713,22	VKCE016E2BD	1.238,19	VKCE016F2BD	1.267,91
20	VKCE020E2D	683,51	VKCE020F2D	713,22	VKCE020E2BD	1.238,19	VKCE020F2BD	1.267,91
25	VKCE025E2D	694,82	VKCE025F2D	726,44	VKCE025E2BD	1.249,47	VKCE025F2BD	1.281,09
32	VKCE032E2D	716,14	VKCE032F2D	744,02	VKCE032E2BD	1.270,79	VKCE032F2BD	1.298,71
40	VKCE040E2D	744,59	VKCE040F2D	771,57	VKCE040E2BD	1.299,27	VKCE040F2BD	1.326,26
50	VKCE050E2D	776,65	VKCE050F2D	818,03	VKCE050E2BD	1.331,28	VKCE050F2BD	1.372,71
63	VKCE063E2D	828,33	VKCE063F2D	887,48	VKCE063E2BD	1.383,01	VKCE063F2BD	1.442,13
75	VKCE075E2D	1.472,11	VKCE075F2D	1.670,33	VKCE075E2BD	2.026,78	VKCE075F2BD	2.224,99
90	VKCE090E2D	1.682,87	VKCE090F2D	1.917,29	VKCE090E2BD	2.237,52	VKCE090F2BD	2.471,98
110	VKCE110E2D	2.243,60	VKCE110F2D	2.478,06	VKCE110E2BD	2.798,28	VKCE110F2BD	3.032,73

Válvula de bola motorizada

en C-PVC 2 vías DUAL BLOCK®.

Actuación eléctrica

Disponemos de otras conexiones bajo pedido: bridas, encolar macho y roscar (GAS,NPT)

Bajo pedido podemos suministrar otros actuadores: VALPES, BELIMO... Bajo pedido también disponibles en 12V AC/DC

VKDIC/CP

Encolar



ACTUACIÓN NEUMÁTICA ALUMINIO

ACTUACIÓN NEUMÁTICA ALUMINIO CON ELECTROVÁLVULA, FINALES DE CARRERA (ELECTROMECÁNICOS) Y REGULADORES DE ESCAPE

d	DOBLE EFECTO		SIMPLE EFECTO		DOBLE EFECTO		SIMPLE EFECTO	
	Ref.	€	Ref.	€	Ref.	€	Ref.	€
		EPDM		FKM		EPDM		FKM
16	VKCP016EDED	346,13	VKCP016ESED	376,86	VKCP016EDEFD	546,78	VKCP016ESEFD	588,11
20	VKCP020EDED	346,13	VKCP020ESED	376,86	VKCP020EDEFD	546,78	VKCP020ESEFD	588,11
25	VKCP025EDED	357,41	VKCP025ESED	388,13	VKCP025EDEFD	558,05	VKCP025ESEFD	599,36
32	VKCP032EDED	378,76	VKCP032ESED	409,43	VKCP032EDEFD	579,38	VKCP032ESEFD	620,68
40	VKCP040EDED	407,19	VKCP040ESED	437,90	VKCP040EDEFD	607,83	VKCP040ESEFD	649,14
50	VKCP050EDED	439,22	VKCP050ESED	529,57	VKCP050EDEFD	639,87	VKCP050ESEFD	740,81
63	VKCP063EDED	490,98	VKCP063ESED	660,21	VKCP063EDEFD	691,59	VKCP063ESEFD	871,43
75	VKCP075EDED	973,40	VKCP075ESED	1.093,14	VKCP075EDEFD	1.174,02	VKCP075ESEFD	1.304,37
90	VKCP090EDED	1.184,17	VKCP090ESED	1.303,91	VKCP090EDEFD	1.384,78	VKCP090ESEFD	1.515,13
110	VKCP110EDED	1.394,24	VKCP110ESED	1.818,03	VKCP110EDEFD	1.594,88	VKCP110ESEFD	2.029,23

16	VKCP016FDED	375,88	VKCP016FSED	406,59	VKCP016FDEFD	576,49	VKCP016FSEFD	617,79
20	VKCP020FDED	375,88	VKCP020FSED	406,59	VKCP020FDEFD	576,49	VKCP020FSEFD	617,79
25	VKCP025FDED	389,06	VKCP025FSED	419,76	VKCP025FDEFD	589,65	VKCP025FSEFD	630,98
32	VKCP032FDED	406,62	VKCP032FSED	437,34	VKCP032FDEFD	607,27	VKCP032FSEFD	648,57
40	VKCP040FDED	434,20	VKCP040FSED	464,89	VKCP040FDEFD	634,84	VKCP040FSEFD	676,12
50	VKCP050FDED	480,65	VKCP050FSED	571,01	VKCP050FDEFD	681,27	VKCP050FSEFD	782,26
63	VKCP063FDED	550,10	VKCP063FSED	719,33	VKCP063FDEFD	750,72	VKCP063FSEFD	930,55
75	VKCP075FDED	1.171,60	VKCP075FSED	1.291,34	VKCP075FDEFD	1.372,25	VKCP075FSEFD	1.502,59
90	VKCP090FDED	1.418,60	VKCP090FSED	1.538,34	VKCP090FDEFD	1.619,24	VKCP090FSEFD	1.749,56
110	VKCP110FDED	1.628,69	VKCP110FSED	2.052,46	VKCP110FDEFD	1.829,31	VKCP110FSEFD	2.263,66

Válvula de bola motorizada

en C-PVC 2 vías DUAL BLOCK®. Actuación eléctrica.

Disponemos de otras conexiones bajo pedido: bridas, encolar macho y roscar (GAS,NPT)

Las válvulas neumáticas se configuran NC (normalmente cerrada) de serie.

La configuración NA (normalmente abierta) se debe especificar en el pedido

VKDIC/CP

Encolar



ACTUACIÓN NEUMÁTICA POLIAMIDA

ACTUACIÓN NEUMÁTICA POLIAMIDA CON ELECTROVÁLVULA, FINALES DE CARRERA (ELECTROMECAÑICOS) Y REGULADORES DE ESCAPE

d	DOBLE EFECTO		SIMPLE EFECTO		DOBLE EFECTO		SIMPLE EFECTO	
	Ref.	€ EPDM	Ref	€ FKM	Ref.	€ EPDM	Ref.	€ FKM
16	VKCP016EDEP	364,86	VKCP016ESEP	388,00	VKCP016EDEF	627,30	VKCP016ESEFP	650,45
20	VKCP020EDEP	364,86	VKCP020ESEP	388,00	VKCP020EDEF	627,30	VKCP020ESEFP	650,45
25	VKCP025EDEP	376,16	VKCP025ESEP	399,31	VKCP025EDEF	638,60	VKCP025ESEFP	661,75
32	VKCP032EDEP	397,46	VKCP032ESEP	524,73	VKCP032EDEF	659,90	VKCP032ESEFP	787,16
40	VKCP040EDEP	425,94	VKCP040ESEP	553,16	VKCP040EDEF	688,38	VKCP040ESEFP	815,61
50	VKCP050EDEP	457,97	VKCP050ESEP	706,66	VKCP050EDEF	720,43	VKCP050ESEFP	969,08
63	VKCP063EDEP	713,77	VKCP063ESEP	780,28	VKCP063EDEF	976,21	VKCP063ESEFP	1.042,72
75	VKCP075EDEP	1.102,44	VKCP075ESEP	1.351,57	VKCP075EDEF	1.364,85	VKCP075ESEFP	1.614,01
90	VKCP090EDEP	1.313,20	VKCP090ESEP	1.562,33	VKCP090EDEF	1.575,62	VKCP090ESEFP	1.824,80
110	VKCP110EDEP	1.489,84	VKCP110ESEP	1.760,25	VKCP110EDEF	1.752,29	VKCP110ESEFP	2.022,71
16	VKCP016FDEP	394,62	VKCP016FSEP	417,77	VKCP016FDEF	657,04	VKCP016FSEFD	617,79
20	VKCP020FDEP	394,62	VKCP020FSEP	417,77	VKCP020FDEF	657,04	VKCP020FSEFD	617,79
25	VKCP025FDEP	407,81	VKCP025FSEP	430,93	VKCP025FDEF	670,22	VKCP025FSEFD	630,98
32	VKCP032FDEP	425,37	VKCP032FSEP	552,63	VKCP032FDEF	687,81	VKCP032FSEFD	648,57
40	VKCP040FDEP	452,92	VKCP040FSEP	580,18	VKCP040FDEF	715,37	VKCP040FSEFD	676,12
50	VKCP050FDEP	499,37	VKCP050FSEP	748,09	VKCP050FDEF	761,82	VKCP050FSEFD	782,26
63	VKCP063FDEP	772,89	VKCP063FSEP	839,40	VKCP063FDEF	1.035,34	VKCP063FSEFD	930,55
75	VKCP075FDEP	1.300,63	VKCP075FSEP	1.549,77	VKCP075FDEF	1.563,08	VKCP075FSEFD	1.502,59
90	VKCP090FDEP	1.547,61	VKCP090FSEP	1.796,76	VKCP090FDEF	1.810,05	VKCP090FSEFD	1.749,56
110	VKCP110FDEP	1.724,27	VKCP110FSEP	1.994,68	VKCP110FDEF	1.986,72	VKCP110FSEFD	2.263,66

Válvula de bola motorizada en C-PVC 2 vías DUAL BLOCK®. Actuación eléctrica.

Disponemos de otras conexiones bajo pedido: bridas, encolar macho y roscar (GAS, NPT)
 Las válvulas neumáticas se configuran NC (normalmente cerrada) de serie.
 La configuración NA (normalmente abierta) se debe especificar en el pedido



INDUSTRIA

Sistema C-PVC

Válvulas de 3 vías actuadas



LKDIC/CE

Encolar



ACTUACIÓN ELÉCTRICA

ACTUACIÓN ELÉCTRICA CON BLOQUE DE SEGURIDAD

d	24-240 V AC/DC		24-240 V AC/DC		24-240 V AC/DC		24-240 V AC/DC	
	Ref.	€	Ref.	€	Ref.	€	Ref.	€
16	LKCE016E2D	801,24	LKCE016F2D	816,79	LKCE016E2BD	1.355,92	LKCE016F2BD	1.371,45
20	LKCE020E2D	801,24	LKCE020F2D	816,79	LKCE020E2BD	1.355,92	LKCE020F2BD	1.371,45
25	LKCE025E2D	822,51	LKCE025F2D	843,24	LKCE025E2BD	1.377,19	LKCE025F2BD	1.397,92
32	LKCE032E2D	868,91	LKCE032F2D	894,66	LKCE032E2BD	1.423,56	LKCE032F2BD	1.449,29
40	LKCE040E2D	943,15	LKCE040F2D	980,35	LKCE040E2BD	1.497,81	LKCE040F2BD	1.535,01
50	LKCE050E2D	982,21	LKCE050F2D	1.044,68	LKCE050E2BD	1.536,89	LKCE050F2BD	1.599,33
63	LKCE063E2D	1.091,39	LKCE063F2D	1.170,08	LKCE063E2BD	1.646,02	LKCE063F2BD	1.724,74

Válvula de bola motorizada en C-PVC 3 vías DUAL BLOCK®. Actuación eléctrica

Estándar paso en L, paso en T opcional, al mismo precio. Disponemos de otras conexiones bajo pedido: bridas, encolar macho y roscar (GAS, NPT) Bajo pedido podemos suministrar otros actuadores: VALPES, BELIMO...

Bajo pedido también disponibles en 12V AC/DC

LKDIC/CP

Encolar



ACTUACIÓN NEUMÁTICA ALUMINIO

ACTUACIÓN NEUMÁTICA ALUMINIO CON ELECTROVÁLVULA, FINALES DE CARRERA (ELECTROMECÁNICOS) Y REGULADORES DE ESCAPE

d	DOBLE EFECTO		SIMPLE EFECTO		DOBLE EFECTO		SIMPLE EFECTO	
	Ref.	€	Ref.	€	Ref.	€	Ref.	€
16	LKCP016EDED	463,86	LKCP016ESED	494,59	LKCP016EDEFD	664,50	LKCP016ESEFD	705,79
20	LKCP020EDED	463,86	LKCP020ESED	494,59	LKCP020EDEFD	664,50	LKCP020ESEFD	705,79
25	LKCP025EDED	485,13	LKCP025ESED	515,85	LKCP025EDEFD	685,77	LKCP025ESEFD	727,08
32	LKCP032EDED	531,51	LKCP032ESED	562,26	LKCP032EDEFD	732,15	LKCP032ESEFD	773,46
40	LKCP040EDED	605,79	LKCP040ESED	696,13	LKCP040EDEFD	806,42	LKCP040ESEFD	907,33
50	LKCP050EDED	680,62	LKCP050ESED	814,09	LKCP050EDEFD	881,22	LKCP050ESEFD	1.025,29
63	LKCP063EDED	789,73	LKCP063ESED	923,19	LKCP063EDEFD	990,35	LKCP063ESEFD	1.134,44
16	LKCP016FDED	479,39	LKCP016FSED	510,09	LKCP016FDEFD	680,01	LKCP016FSEFD	721,34
20	LKCP020FDED	479,39	LKCP020FSED	510,09	LKCP020FDEFD	680,01	LKCP020FSEFD	721,34
25	LKCP025FDED	505,86	LKCP025FSED	536,58	LKCP025FDEFD	706,51	LKCP025FSEFD	747,81
32	LKCP032FDED	557,26	LKCP032FSED	587,95	LKCP032FDEFD	757,87	LKCP032FSEFD	799,21
40	LKCP040FDED	642,96	LKCP040FSED	733,31	LKCP040FDEFD	843,57	LKCP040FSEFD	944,54
50	LKCP050FDED	743,04	LKCP050FSED	876,53	LKCP050FDEFD	943,69	LKCP050FSEFD	1.087,78
63	LKCP063FDED	868,42	LKCP063FSED	1.001,96	LKCP063FDEFD	1.069,07	LKCP063FSEFD	1.213,16

Válvula de bola motorizada en C-PVC 3 vías DUAL BLOCK®. Actuación neumática

Estándar paso en L, paso en T opcional, al mismo precio. Disponemos de otras conexiones bajo pedido: bridas, encolar macho y roscar (GAS, NPT) Las válvulas neumáticas se configuran NC (normalmente cerrada) de serie. La configuración NA (normalmente abierta) se debe especificar en el pedido

LKDIC/CP

Encolar



ACTUACIÓN NEUMÁTICA POLIAMIDA

ACTUACIÓN NEUMÁTICA POLIAMIDA CON ELECTROVÁLVULA, FINALES DE CARRERA (ELECTROMECAÑICOS) Y REGULADORES DE ESCAPE

d	DOBLE EFECTO		SIMPLE EFECTO		DOBLE EFECTO		SIMPLE EFECTO	
	Ref.	€ EPDM	Ref.	€ FKM	Ref.	€ EPDM	Ref.	€ FKM
16	LKCP016EDEP	522,03	LKCP016ESEP	545,16	LKCP016EDEFP	784,48	LKCP016ESEFP	807,60
20	LKCP020EDEP	522,03	LKCP020ESEP	545,16	LKCP020EDEFP	784,48	LKCP020ESEFP	807,60
25	LKCP025EDEP	588,47	LKCP025ESEP	611,61	LKCP025EDEFP	850,91	LKCP025ESEFP	874,06
32	LKCP032EDEP	634,89	LKCP032ESEP	762,13	LKCP032EDEFP	897,32	LKCP032ESEFP	1.024,57
40	LKCP040EDEP	724,04	LKCP040ESEP	972,71	LKCP040EDEFP	986,46	LKCP040ESEFP	1.235,16
50	LKCP050EDEP	856,08	LKCP050ESEP	1.009,33	LKCP050EDEFP	1.118,51	LKCP050ESEFP	1.271,77
63	LKCP063EDEP	1.041,36	LKCP063ESEP	1.107,87	LKCP063EDEFP	1.303,77	LKCP063ESEFP	1.370,31

d	DOBLE EFECTO		SIMPLE EFECTO		DOBLE EFECTO		SIMPLE EFECTO	
	Ref.	€ EPDM	Ref.	€ FKM	Ref.	€ EPDM	Ref.	€ FKM
16	LKCP016FDEP	537,54	LKCP016FSEP	560,68	LKCP016FDEFP	799,98	LKCP016FSEFP	823,10
20	LKCP020FDEP	537,54	LKCP020FSEP	560,68	LKCP020FDEFP	799,98	LKCP020FSEFP	823,10
25	LKCP025FDEP	609,19	LKCP025FSEP	632,37	LKCP025FDEFP	871,67	LKCP025FSEFP	894,81
32	LKCP032FDEP	660,59	LKCP032FSEP	787,85	LKCP032FDEFP	923,03	LKCP032FSEFP	1.050,29
40	LKCP040FDEP	761,22	LKCP040FSEP	1.009,92	LKCP040FDEFP	1.023,64	LKCP040FSEFP	1.272,36
50	LKCP050FDEP	918,50	LKCP050FSEP	1.071,77	LKCP050FDEFP	1.180,98	LKCP050FSEFP	1.334,21
63	LKCP063FDEP	1.120,07	LKCP063FSEP	1.186,59	LKCP063FDEFP	1.382,52	LKCP063FSEFP	1.449,00

Válvula de bola motorizada en C-PVC 3 vías DUAL BLOCK®. Actuación neumática.

Estándar paso en L, paso en T opcional, al mismo precio. Disponemos de otras conexiones bajo pedido: bridas, encolar macho y roscar (GAS, NPT). Las válvulas neumáticas se configuran NC (normalmente cerrada) de serie. La configuración NA (normalmente abierta) se debe especificar en el pedido.

FKOC/CE

ACTUACIÓN ELÉCTRICA

ACTUACIÓN ELÉCTRICA CON BLOQUE DE SEGURIDAD

d	24-240 V AC/DC		24-240 V AC/DC		24-240 V AC/DC		24-240 V AC/DC	
	Ref.	€ EPDM	Ref.	€ FKM	Ref.	€ EPDM	Ref.	€ FKM
50	FKCE050E2D	889,41	FKCE050F2D	1.053,62	FKCE050E2BD	1.444,11	FKCE050F2BD	1.608,29
63	FKCE063E2D	909,47	FKCE063F2D	1.083,23	FKCE063E2BD	1.464,15	FKCE063F2BD	1.637,91
75	FKCE075E2D	1.209,15	FKCE075F2D	1.402,32	FKCE075E2BD	1.763,82	FKCE075F2BD	1.957,03
90	FKCE090E2D	1.244,06	FKCE090F2D	1.445,81	FKCE090E2BD	1.798,72	FKCE090F2BD	2.000,47
110	FKCE110E2D	1.281,73	FKCE110F2D	1.490,82	FKCE110E2BD	1.836,39	FKCE110F2BD	2.045,51
125	FKCE140E2D	1.803,02	FKCE140F2D	2.087,58	FKCE140E2BD	2.357,67	FKCE140F2BD	2.642,24
140	FKCE140E2D	1.803,02	FKCE140F2D	2.087,58	FKCE140E2BD	2.357,67	FKCE140F2BD	2.642,24
160	FKCE160E2D	2.110,24	FKCE160F2D	2.393,44	FKCE160E2BD	2.759,35	FKCE160F2BD	3.042,50
200 - 225	FKCE225E2D	2.458,87	FKCE225F2D	2.827,61	FKCE225E2BD	3.107,95	FKCE225F2BD	3.476,71
250	FKCE280E2D	4.498,22	FKCE280F2D	6.191,48	FKCE280E2BD	5.147,32	FKCE280F2BD	6.840,57
280	FKCE280E2D	4.498,22	FKCE280F2D	6.191,48	FKCE280E2BD	5.147,32	FKCE280F2BD	6.840,57
315	FKCE315E2D	4.756,78	FKCE315F2D	6.603,95	FKCE315E2BD	5.405,85	FKCE315F2BD	7.253,05

Válvula de mariposa industrial motorizada cuerpo en PPGR y disco en C-PVC. Actuación eléctrica.

Bajo pedido podemos suministrar otros actuadores: VALPES, BELIMO...
 Bajo pedido también disponibles en 12V AC/DC



FKOC/CP

ACTUACIÓN NEUMÁTICA ALUMINIO

ACTUACIÓN NEUMÁTICA ALUMINIO CON ELECTROVÁLVULA, FINALES DE CARRERA (ELECTROMECAÑICOS) Y REGULADORES DE ESCAPE

d	DOBLE EFECTO			SIMPLE EFECTO		DOBLE EFECTO		DOBLE EFECTO	
	Ref.	€		Ref.	€	Ref.	€	Ref.	€
50	FKCP050EDED	551,70		FKCP050ESED	642,05	FKCP050EDEFD	752,34	FKCP050ESEFD	853,25
63	FKCP063EDED	571,75		FKCP063ESED	662,11	FKCP063EDEFD	772,38	FKCP063ESEFD	873,32
75	FKCP075EDED	647,56		FKCP075ESED	781,03	FKCP075EDEFD	848,15	FKCP075ESEFD	992,25
90	FKCP090EDED	744,98		FKCP090ESED	864,74	FKCP090EDEFD	945,62	FKCP090ESEFD	1.075,97
110	FKCP110EDED	782,70		FKCP110ESED	1.233,46	FKCP110EDEFD	983,32	FKCP110ESEFD	1.444,68
125	FKCP140EDED	970,81		FKCP140ESED	1.648,24	FKCP140EDEFD	1.171,45	FKCP140ESEFD	1.859,44
140	FKCP140EDED	970,81		FKCP140ESED	1.648,24	FKCP140EDEFD	1.171,45	FKCP140ESEFD	1.859,44
160	FKCP160EDED	1.036,13		FKCP160ESED	1.713,51	FKCP160EDEFD	1.236,75	FKCP160ESEFD	1.924,74
200 - 225	FKCP225EDED	1.523,68		FKCP225ESED	2.453,39	FKCP225EDEFD	1.724,27	FKCP225ESEFD	2.664,56
250	FKCP280EDED	3.743,95		FKCP280ESED	5.714,93	FKCP280EDEFD	3.944,59	FKCP280ESEFD	5.926,16
280	FKCP280EDED	3.743,95		FKCP280ESED	5.714,93	FKCP280EDEFD	3.944,59	FKCP280ESEFD	5.926,16
315	FKCP315EDED	4.270,57		FKCP315ESED	6.991,69	FKCP315EDEFD	4.471,18	FKCP315ESEFD	7.202,89
50	FKCP050FDED	715,88		FKCP050FSED	806,23	FKCP050FDEFD	916,52	FKCP050FSEFD	1.017,46
63	FKCP063FDED	745,49		FKCP063FSED	835,85	FKCP063FDEFD	946,14	FKCP063FSEFD	1.047,08
75	FKCP075FDED	840,72		FKCP075FSED	974,20	FKCP075FDEFD	1.041,36	FKCP075FSEFD	1.185,43
90	FKCP090FDED	946,76		FKCP090FSED	1.066,49	FKCP090FDEFD	1.147,37	FKCP090FSEFD	1.277,72
110	FKCP110FDED	991,79		FKCP110FSED	1.442,57	FKCP110FDEFD	1.192,41	FKCP110FSEFD	1.653,77
125	FKCP140FDED	1.255,39		FKCP140FSED	1.932,77	FKCP140FDEFD	1.456,01	FKCP140FSEFD	2.144,00
140	FKCP140FDED	1.255,39		FKCP140FSED	1.932,77	FKCP140FDEFD	1.456,01	FKCP140FSEFD	2.144,00
160*	FKCP160FDED	1.319,31		FKCP160FSED	1.996,71	FKCP160FDEFD	1.519,95	FKCP160FSEFD	2.207,94
200 - 225	FKCP225FDED	1.892,45		FKCP225FSED	2.822,13	FKCP225FDEFD	2.093,06	FKCP225FSEFD	3.033,33
250	FKCP280FDED	5.437,19		FKCP280FSED	7.408,15	FKCP280FDEFD	5.637,81	FKCP280FSEFD	7.619,40
280	FKCP280FDED	5.437,19		FKCP280FSED	7.408,15	FKCP280FDEFD	5.637,81	FKCP280FSEFD	7.619,40
315	FKCP315FDED	6.117,72		FKCP315FSED	8.838,87	FKCP315FDEFD	6.318,36	FKCP315FSEFD	9.050,10

Válvula de mariposa industrial motorizada
cuerpo en PPGR y disco en C-PVC
Actuación neumática.

Las válvulas neumáticas se configuran NC (normalmente cerrada) de serie.
La configuración NA (normalmente abierta) se debe especificar en el pedido



FKOC/CP

ACTUACIÓN NEUMÁTICA POLIAMIDA

ACTUACIÓN NEUMÁTICA POLIAMIDA CON ELECTROVÁLVULA, FINALES DE CARRERA (ELECTROMECAÑICOS) Y REGULADORES DE ESCAPE

d	DOBLE EFECTO		SIMPLE EFECTO		DOBLE EFECTO		DOBLE EFECTO	
	Ref.	€	Ref.	€	Ref.	€	Ref.	€
50	FKCP050EDEP	658,66	FKCP050ESEP	821,82	FKCP050EDEFPP	921,08	FKCP050ESEFP	1.084,26
63	FKCP063EDEP	678,70	FKCP063ESEP	841,87	FKCP063EDEFPP	941,14	FKCP063ESEFP	1.104,31
75	FKCP075EDEP	718,76	FKCP075ESEP	881,92	FKCP075EDEFPP	981,21	FKCP075ESEFP	1.144,36
90	FKCP090EDEP	849,94	FKCP090ESEP	916,47	FKCP090EDEFPP	1.112,40	FKCP090ESEFP	1.178,89
110	FKCP110EDEP	887,65	FKCP110ESEP	1.149,38	FKCP110EDEFPP	1.150,08	FKCP110ESEFP	1.411,82
125	FKCP140EDEP	1.034,48	FKCP140ESEP	1.596,38	FKCP140EDEFPP	1.296,92	FKCP140ESEFP	1.858,79
140	FKCP140EDEP	1.034,48	FKCP140ESEP	1.596,38	FKCP140EDEFPP	1.296,92	FKCP140ESEFP	1.858,79
160	FKCP160EDEP	1.283,38	FKCP160ESEP	1.661,68	FKCP160EDEFPP	1.545,82	FKCP160ESEFP	1.924,12
200	FKCP225EDEP	1.505,07	FKCP225ESEP	2.285,72	FKCP225EDEFPP	1.767,51	FKCP225ESEFP	2.548,15
225	FKCP225EDEP	1.505,07	FKCP225ESEP	2.285,72	FKCP225EDEFPP	1.767,51	FKCP225ESEFP	2.548,15
250*	FKCP280EDEP	3.922,65	FKCP280ESEP	5.596,18	FKCP280EDEFPP	4.185,08	FKCP280ESEFP	5.858,62
280*	FKCP280EDEP	3.922,65	FKCP280ESEP	5.596,18	FKCP280EDEFPP	4.185,08	FKCP280ESEFP	5.858,62
315*	FKCP315EDEP	4.181,21	FKCP315ESEP	5.854,76	FKCP315EDEFPP	4.443,66	FKCP315ESEFP	6.117,15
<hr/>								
50	FKCP050FDEP	822,85	FKCP050FSEP	986,00	FKCP050FDEFPP	1.085,29	FKCP050FSEFP	1.248,44
63	FKCP063FDEP	852,46	FKCP063FSEP	1.015,63	FKCP063FDEFPP	1.114,90	FKCP063FSEFP	1.278,05
75	FKCP075FDEP	911,94	FKCP075FSEP	1.075,09	FKCP075FDEFPP	1.174,35	FKCP075FSEFP	1.337,56
90	FKCP090FDEP	1.051,73	FKCP090FSEP	1.118,25	FKCP090FDEFPP	1.314,16	FKCP090FSEFP	1.380,66
110	FKCP110FDEP	1.096,74	FKCP110FSEP	1.358,50	FKCP110FDEFPP	1.359,19	FKCP110FSEFP	1.620,96
125	FKCP140FDEP	1.319,02	FKCP140FSEP	1.880,91	FKCP140FDEFPP	1.581,49	FKCP140FSEFP	2.143,36
140	FKCP140FDEP	1.319,02	FKCP140FSEP	1.880,91	FKCP140FDEFPP	1.581,49	FKCP140FSEFP	2.143,36
160*	FKCP160FDEP	1.566,56	FKCP160FSEP	1.944,85	FKCP160FDEFPP	1.829,00	FKCP160FSEFP	2.207,27
200	FKCP225FDEP	1.873,83	FKCP225FSEP	2.654,50	FKCP225FDEFPP	2.136,25	FKCP225FSEFP	2.916,94
225	FKCP225FDEP	1.873,83	FKCP225FSEP	2.654,50	FKCP225FDEFPP	2.136,25	FKCP225FSEFP	2.916,94
250*	FKCP280FDEP	5.615,87	FKCP280FSEP	7.289,41	FKCP280FDEFPP	5.878,29	FKCP280FSEFP	7.551,86
280*	FKCP280FDEP	5.615,87	FKCP280FSEP	7.289,41	FKCP280FDEFPP	5.878,29	FKCP280FSEFP	7.551,86
315*	FKCP315FDEP	6.028,36	FKCP315FSEP	7.701,91	FKCP315FDEFPP	6.290,81	FKCP315FSEFP	7.964,35

Válvula de mariposa industrial motorizada
 cuerpo en PPGR y disco en C-PVC
 Actuación neumática.

Las válvulas neumáticas se configuran NC (normalmente cerrada) de serie.
 La configuración NA (normalmente abierta) se debe especificar en el pedido
 * Actuadores de aluminio



Sistema C-PVC

Válvulas de membrana actuadas

**DK/CP NC****VM/CP NC**

d	Modelo.	DN	Ref. EPDM	€ EPDM	Ref. FKM	€ FKM	Ref. PTFE	€ PTFE
20	DKDC/CP NC	15	DKDCNC020E	396,55	DKDCNC020F	499,76	DKDCNC020P	514,67
25	DKDC/CP NC	20	DKDCNC025E	414,99	DKDCNC025F	519,31	DKDCNC025P	534,81
32	DKDC/CP NC	25	DKDCNC032E	508,44	DKDCNC032F	634,15	DKDCNC032P	669,55
40	DKDC/CP NC	32	DKDCNC040E	667,32	DKDCNC040F	850,76	DKDCNC040P	888,77
50	DKDC/CP NC	40	DKDCNC050E	756,31	DKDCNC050F	959,37	DKDCNC050P	959,37
63	DKDC/CP NC	50	DKDCNC063E	1.043,78	DKDCNC063F	1.370,39	DKDCNC063P	1.341,37
75	DKDC/CP NC	65	DKDCNC075E	1.252,48	DKDCNC075F	1.644,45	DKDCNC075P	1.609,68
90	VMDC/CP NC	80	VMDCNC090E	1.893,53	VMDCNC090F	2.521,83	VMDCNC090P	2.189,63
110	VMDC/CP NC	100	VMDCNC110E	2.298,50	VMDCNC110F	2.915,91	VMDCNC110P	2.589,30

Válvula neumática **NORMALMENTE CERRADA.**

M-M encolar

DK/CP NO**VM/CP NO**

d	Modelo.	DN	Ref. EPDM	€ EPDM	Ref. FKM	€ FKM	Ref. PTFE	€ PTFE
20	DKDC/CP NO	15	DKDCNO020E	357,41	DKDCNO020F	467,57	DKDCNO020P	501,10
25	DKDC/CP NO	20	DKDCNO025E	377,08	DKDCNO025F	488,48	DKDCNO025P	523,24
32	DKDC/CP NO	25	DKDCNO032E	446,02	DKDCNO032F	512,22	DKDCNO032P	560,04
40	DKDC/CP NO	32	DKDCNO040E	480,63	DKDCNO040F	705,99	DKDCNO040P	758,96
50	DKDC/CP NO	40	DKDCNO050E	560,22	DKDCNO050F	803,97	DKDCNO050P	803,97
63	DKDC/CP NO	50	DKDCNO063E	713,33	DKDCNO063F	1.106,25	DKDCNO063P	1.106,25
75	DKDC/CP NO	65	DKDCNO075E	855,98	DKDCNO075F	1.327,49	DKDCNO075P	1.327,49
90	VMDC/CP NO	80	VMDCNO090E	1.336,01	VMDCNO090F	2.113,20	VMDCNO090P	1.911,73
110	VMDC/CP NO	100	VMDCNO110E	2.029,18	VMDCNO110F	2.443,42	VMDCNO110P	2.133,01

Válvula neumática **NORMALMENTE ABIERTA.**

M-M encolar

DK/CP DE**VM/CP DE**

d	Modelo.	DN	Ref. EPDM	€ EPDM	Ref. FKM	€ FKM	Ref. PTFE	€ PTFE
20	DKDC/CP DE	15	DKDCDA020E	272,72	DKDCDA020F	375,90	DKDCDA020P	396,91
25	DKDC/CP DE	20	DKDCDA025E	291,11	DKDCDA025F	395,45	DKDCDA025P	416,94
32	DKDC/CP DE	25	DKDCDA032E	393,23	DKDCDA032F	465,69	DKDCDA032P	509,16
40	DKDC/CP DE	32	DKDCDA040E	436,98	DKDCDA040F	641,79	DKDCDA040P	689,92
50	DKDC/CP DE	40	DKDCDA050E	530,06	DKDCDA050F	760,68	DKDCDA050P	760,68
63	DKDC/CP DE	50	DKDCDA063E	674,92	DKDCDA063F	1.046,69	DKDCDA063P	1.046,69
75	DKDC/CP DE	65	DKDCDA075E	809,90	DKDCDA075F	1.256,02	DKDCDA075P	1.256,02
90	VMDC/CP DE	80	VMDCDA090E	1.621,07	VMDCDA090F	2.398,28	VMDCDA090P	2.196,78
110	VMDC/CP DE	100	VMDCDA110E	2.159,03	VMDCDA110F	2.773,05	VMDCDA110P	2.451,09

Válvula neumática **DOBLE EFECTO.**

M-M encolar



DK/CP NC

d	Modelo.	DN	Ref. EPDM	€ EPDM	Ref. FKM	€ FKM	Ref. PTFE	€ PTFE
20	DKUIC/CP NC	15	DKUICNC020E	411,28	DKUICNC020F	514,43	DKUICNC020P	535,91
25	DKUIC/CP NC	20	DKUICNC025E	430,95	DKUICNC025F	535,32	DKUICNC025P	569,69
32	DKUIC/CP NC	25	DKUICNC032E	530,12	DKUICNC032F	654,31	DKUICNC032P	697,34
40	DKUIC/CP NC	32	DKUICNC040E	700,53	DKUICNC040F	883,98	DKUICNC040P	928,03
50	DKUIC/CP NC	40	DKUICNC050E	793,77	DKUICNC050F	996,92	DKUICNC050P	996,92
63	DKUIC/CP NC	50	DKUICNC063E	1.103,21	DKUICNC063F	1.429,74	DKUICNC063P	1.429,74

Válvula neumática **NORMALMENTE CERRADA.**

Con enlaces H-H encolar



DK/CP NO

d	Modelo.	DN	Ref. EPDM	€ EPDM	Ref. FKM	€ FKM	Ref. PTFE	€ PTFE
20	DKUIC/CP NO	15	DKUICNO020E	373,15	DKUICNO020F	483,31	DKUICNO020P	524,68
25	DKUIC/CP NO	20	DKUICNO025E	394,13	DKUICNO025F	505,58	DKUICNO025P	562,26
32	DKUIC/CP NO	25	DKUICNO032E	475,40	DKUICNO032F	538,31	DKUICNO032P	597,38
40	DKUIC/CP NO	32	DKUICNO040E	523,39	DKUICNO040F	748,81	DKUICNO040P	808,86
50	DKUIC/CP NO	40	DKUICNO050E	610,58	DKUICNO050F	852,38	DKUICNO050P	852,38
63	DKUIC/CP NO	50	DKUICNO063E	787,90	DKUICNO063F	1.182,78	DKUICNO063P	1.182,78

Válvula neumática **NORMALMENTE ABIERTA.**

Con enlaces H-H encolar



DK/CP DE

d	Modelo.	DN	Ref. EPDM	€ EPDM	Ref. FKM	€ FKM	Ref. PTFE	€ PTFE
20	DKUIC/CP DE	15	DKUICDA020E	287,42	DKUICDA020F	390,61	DKUICDA020P	418,44
25	DKUIC/CP DE	20	DKUICDA025E	307,09	DKUICDA025F	411,46	DKUICDA025P	453,15
32	DKUIC/CP DE	25	DKUICDA032E	420,65	DKUICDA032F	575,29	DKUICDA032P	543,10
40	DKUIC/CP DE	32	DKUICDA040E	475,84	DKUICDA040F	680,76	DKUICDA040P	735,40
50	DKUIC/CP DE	40	DKUICDA050E	577,71	DKUICDA050F	806,49	DKUICDA050P	806,49
63	DKUIC/CP DE	50	DKUICDA063E	745,47	DKUICDA063F	1.119,11	DKUICDA063P	1.119,11

Válvula neumática **DOBLE EFECTO.**

Con enlaces H-H encolar



DK/CP NC

Rh	Modelo.	DN	Ref. EPDM	€ EPDM	Ref. FKM	€ FKM	Ref. PTFE	€ PTFE
1/2"	DKUFC/CP NC	15	DKUFCNC012E	452,43	DKUFCNC012F	509,28	DKUFCNC012P	565,88
3/4"	DKUFC/CP NC	20	DKUFCNC034E	474,04	DKUFCNC034F	529,97	DKUFCNC034P	588,80
1"	DKUFC/CP NC	25	DKUFCNC100E	583,11	DKUFCNC100F	719,76	DKUFCNC100P	767,09
1 1/4"	DKUFC/CP NC	32	DKUFCNC114E	770,57	DKUFCNC114F	972,37	DKUFCNC114P	1.020,83
1 1/2"	DKUFC/CP NC	40	DKUFCNC112E	873,13	DKUFCNC112F	1.096,59	DKUFCNC112P	1.096,59
2"	DKUFC/CP NC	50	DKUFCNC200E	1.213,49	DKUFCNC200F	1.771,09	DKUFCNC200P	1.572,71

Válvula neumática **NORMALMENTE CERRADA.**

Con enlaces H-H roscar.



DK/CP NO

Rh	Modelo.	DN	Ref. EPDM	€ EPDM	Ref. FKM	€ FKM	Ref. PTFE	€ PTFE
1/2"	DKUFC/CP NO	15	DKUFCNO012E	417,08	DKUFCNO012F	477,82	DKUFCNO012P	538,23
3/4"	DKUFC/CP NO	20	DKUFCNO034E	440,12	DKUFCNO034F	499,86	DKUFCNO034P	562,74
1"	DKUFC/CP NO	25	DKUFCNO100E	523,09	DKUFCNO100F	592,15	DKUFCNO100P	657,14
1 1/4"	DKUFC/CP NO	32	DKUFCNO114E	575,72	DKUFCNO114F	823,72	DKUFCNO114P	889,80
1 1/2"	DKUFC/CP NO	40	DKUFCNO112E	671,66	DKUFCNO112F	937,64	DKUFCNO112P	937,64
2"	DKUFC/CP NO	50	DKUFCNO200E	866,69	DKUFCNO200F	1.301,08	DKUFCNO200P	1.301,08

Válvula neumática **NORMALMENTE ABIERTA.**

Con enlaces H-H roscar.



DK/CP DE

Rh	Modelo.	DN	Ref. EPDM	€ EPDM	Ref. FKM	€ FKM	Ref. PTFE	€ PTFE
1/2"	DKUFC/CP DE	15	DKUFCDA012E	328,60	DKUFCDA012F	385,43	DKUFCDA012P	442,02
3/4"	DKUFC/CP DE	20	DKUFCDA034E	350,20	DKUFCDA034F	406,11	DKUFCDA034P	464,99
1"	DKUFC/CP DE	25	DKUFCDA100E	465,97	DKUFCDA100F	538,31	DKUFCDA100P	636,13
1 1/4"	DKUFC/CP DE	32	DKUFCDA114E	523,39	DKUFCDA114F	748,81	DKUFCDA114P	808,91
1 1/2"	DKUFC/CP DE	40	DKUFCDA112E	635,50	DKUFCDA112F	887,11	DKUFCDA112P	887,11
2"	DKUFC/CP DE	50	DKUFCDA200E	820,00	DKUFCDA200F	1.231,00	DKUFCDA200P	1.231,00

Válvula neumática **DOBLE EFECTO.**

Con enlaces H-H roscar.



DK/CP NC



VM/CP NC

d	Modelo.	DN	Ref. EPDM	€ EPDM	Ref. FKM	€ FKM	Ref. PTFE	€ PTFE
20	DKOC/CP NC	15	DKOCNC020E	494,89	DKOCNC020F	578,99	DKOCNC020P	592,40
25	DKOC/CP NC	20	DKOCNC025E	497,98	DKOCNC025F	602,32	DKOCNC025P	616,35
32	DKOC/CP NC	25	DKOCNC032E	610,10	DKOCNC032F	735,81	DKOCNC032P	772,17
40	DKOC/CP NC	32	DKOCNC040E	800,72	DKOCNC040F	984,20	DKOCNC040P	1.023,34
50	DKOC/CP NC	40	DKOCNC050E	907,58	DKOCNC050F	1.110,65	DKOCNC050P	1.110,65
63	DKOC/CP NC	50	DKOCNC063E	1.252,56	DKOCNC063F	1.579,18	DKOCNC063P	1.550,08
75	DKOC/CP NC	65	DKOCNC075E	1.503,08	DKOCNC075F	1.894,99	DKOCNC075P	1.860,08
90	VMOC/CP NC	80	VMOCNC090E	2.177,57	VMOCNC090F	2.805,87	VMOCNC090P	2.473,70
110	VMOC/CP NC	100	VMOCNC110E	2.643,32	VMOCNC110F	3.260,00	VMOCNC110P	2.933,93

Válvula neumática **NORMALMENTE CERRADA.**

Con bridas DIN.

Disponibles con bridas ANSI 150 libras al mismo precio



DK/CP NO



VM/CP NO

d	Modelo.	DN	Ref. EPDM	€ EPDM	Ref. FKM	€ FKM	Ref. PTFE	€ PTFE
20	DKOC/CP NO	15	DKOCNO020E	442,11	DKOCNO020F	552,23	DKOCNO020P	586,64
25	DKOC/CP NO	20	DKOCNO025E	465,75	DKOCNO025F	577,14	DKOCNO025P	612,90
32	DKOC/CP NO	25	DKOCNO032E	479,70	DKOCNO032F	624,11	DKOCNO032P	672,90
40	DKOC/CP NO	32	DKOCNO040E	560,94	DKOCNO040F	852,72	DKOCNO040P	907,05
50	DKOC/CP NO	40	DKOCNO050E	726,59	DKOCNO050F	970,39	DKOCNO050P	970,39
63	DKOC/CP NO	50	DKOCNO063E	942,94	DKOCNO063F	1.335,89	DKOCNO063P	1.335,89
75	DKOC/CP NO	65	DKOCNO075E	1.131,51	DKOCNO075F	1.603,04	DKOCNO075P	1.603,04
90	VMOC/CP NO	80	VMOCNO090E	1.620,04	VMOCNO090F	2.397,22	VMOCNO090P	2.195,75
110	VMOC/CP NO	100	VMOCNO110E	2.295,56	VMOCNO110F	2.785,25	VMOCNO110P	2.390,45

Válvula neumática **NORMALMENTE ABIERTA.**

Con bridas DIN.

Disponibles con bridas ANSI 150 libras al mismo precio



DK/CP DE



VM/CP DE

d	Modelo.	DN	Ref. EPDM	€ EPDM	Ref. FKM	€ FKM	Ref. PTFE	€ PTFE
20	DKOC/CP DE	15	DKOCDA020E	352,00	DKOCDA020F	455,14	DKOCDA020P	474,62
25	DKOC/CP DE	20	DKOCDA025E	374,13	DKOCDA025F	478,47	DKOCDA025P	498,40
32	DKOC/CP DE	25	DKOCDA032E	501,43	DKOCDA032F	567,38	DKOCDA032P	611,72
40	DKOC/CP DE	32	DKOCDA040E	570,34	DKOCDA040F	775,21	DKOCDA040P	824,57
50	DKOC/CP DE	40	DKOCDA050E	887,11	DKOCDA050F	918,15	DKOCDA050P	918,15
63	DKOC/CP DE	50	DKOCDA063E	1.231,00	DKOCDA063F	1.263,96	DKOCDA063P	1.263,96
75	DKOC/CP DE	65	DKOCDA075E	687,49	DKOCDA075F	1.516,75	DKOCDA075P	1.516,75
90	VMOC/CP DE	80	VMOCDA090E	1.905,09	VMOCDA090F	2.682,36	VMOCDA090P	2.480,84
110	VMOC/CP DE	100	VMOCDA110E	2.408,74	VMOCDA110F	3.116,50	VMOCDA110P	2.700,81

Válvula neumática **DOBLE EFECTO.**

Con bridas DIN.

Disponibles con bridas ANSI 150 libras al mismo precio

CMDC/CP NC*M-M encolar***CMUIC/CP NC***H-H enlaces encolar*

d	Ref. EPDM	DN	€ EPDM	€ FKM	€ PTFE
20	CMDCNC020E	15	249,88	271,51	271,51
20	CMUICNC020E	15	299,01	326,44	326,44 (A)

Válvula de membrana.
compacta neumática
NORMALMENTE CERRADA.

Código en FKM termina en "F"
en lugar de "E"
Código en PTFE termina en "F"
en lugar de "E"
(A) Juntas en FKM

CMDC/CP NO*M-M encolar***CMUIC/CP NO***H-H enlaces encolar*

d	Ref. EPDM	DN	€ EPDM	€ FKM	€ PTFE
20	CMDCNO020E	15	245,53	268,62	268,62
20	CMUICNO020E	15	294,66	323,52	323,52 (A)

Válvula de membrana.
compacta neumática
NORMALMENTE ABIERTA.

Código en FKM termina en "F"
en lugar de "E"
Código en PTFE termina en "F"
en lugar de "E"
(A) Juntas en FKM

CMDC/CP DA*M-M encolar***CMUIC/CP DA***H-H enlaces encolar*

d	Ref. EPDM	DN	€ EPDM	€ FKM	€ PTFE
20	CMDCDA020E	15	245,53	268,62	268,62
20	CMUICDA020E	15	294,66	323,52	323,52 (A)

Válvula de membrana.
compacta neumática
DOBLE EFECTO.

Código en FKM termina en "F"
en lugar de "E"
Código en PTFE termina en "F"
en lugar de "E"
(A) Juntas en FKM



DKBDC/CP NC

d	Ref. EPDM	DN	PN	€ EPDM
20	DKBDCNC020E	15	6	384,14
25	DKBDCNC025E	20	6	403,30
32	DKBDCNC032E	25	6	501,70
40	DKBDCNC040E	32	6	625,77
50	DKBDCNC050E	40	6	650,62
63	DKBDCNC063E	50	6	911,41
75	DKBDCNC075E	65	6	1.074,37

Válvula de membrana neumática
NORMALMENTE CERRADA.

Actuador a pistón

M-M encolar



DKBUIC/CP NC

d	Ref. EPDM	DN	PN	€ EPDM
20	DKBUICNC020E	15	6	937,21
25	DKBUICNC025E	20	6	636,50
32	DKBUICNC032E	25	6	674,82
40	DKBUICNC040E	32	6	385,57
50	DKBUICNC050E	40	6	407,40
63	DKBUICNC063E	50	6	511,52

Válvula de membrana neumática
NORMALMENTE CERRADA.

Actuador a pistón

Con enlaces H-H encolar



DKBUFC/CP NC

d	Ref. EPDM	DN	PN	€ EPDM
½"	DKBUFCNC012E	15	6	385,57
¾"	DKBUFCNC034E	20	6	407,40
1"	DKBUFCNC100E	25	6	511,52
1 ¼"	DKBUFCNC114E	32	6	636,50
1 ½"	DKBUFCNC112E	40	6	674,82
2"	DKBUFCNC200E	50	6	937,21

Válvula de membrana neumática
NORMALMENTE CERRADA.

Actuador a pistón

Con enlaces H-H para roscar



DKBOC/CP NC

d	Ref. EPDM	DN	PN	€ EPDM
20	DKBOCNC020E	15	6	441,73
25	DKBOCNC025E	20	6	463,75
32	DKBOCNC032E	25	6	587,80
40	DKBOCNC040E	32	6	739,51
50	DKBOCNC050E	40	6	768,87
63	DKBOCNC063E	50	6	1.077,12
75	DKBOCNC075E	65	6	1.375,48

Válvula de membrana neumática
NORMALMENTE CERRADA.

Actuador a pistón

Con bridas DIN



DKBOAC/CP NC

d	Ref. EPDM	DN	PN	€ EPDM
½"	DKBOACNC012E	15	6	441,73
¾"	DKBOACNC034E	20	6	463,75
1"	DKBOACNC100E	25	6	587,80
1 ¼"	DKBOACNC114E	32	6	739,51
1 ½"	DKBOACNC112E	40	6	768,87
2"	DKBOACNC200E	50	6	1.077,12
2 ½"	DKBOACNC212E	65	6	1.375,48

Válvula de membrana neumática
NORMALMENTE CERRADA.

Actuador a pistón

Con bridas ANSI 150 lbs



MANGUITO

d	Ref.	Para válvulas	€
16	ENDIC016	VKD-TKD-VXE-SXE-RV	27,45
20	ENDIC020	VKD-TKD-VXE-SXE-RV	27,45
25	ENDIC025	VKD-TKD-VXE-SXE-RV	46,59
32	ENDIC032	VKD-TKD-VXE-SXE-RV	49,34
40	ENDIC040	VKD-TKD-VXE-SXE-RV	54,85
50	ENDIC050	VKD-TKD-VXE-SXE-RV	60,31
63	ENDIC063	VKD-TKD-VXE-SXE-RV	68,58
75	ENDIC075	VKD-VXE-SSE	82,25
90	ENDIC090	VKD	120,66
90	ENDIC090VXE	VXE-SXE	120,66
110	ENDIC110	VKD	150,79
110	ENDIC110VXE	VXE-SXE	150,79

Conector final en C-PVC.
H encolar.



MANGUITO

Rh	Ref.	Para válvulas	€
3/8"	ENDFC038	VKD-TKD-VXE-SXE-RV	27,45
1/2"	ENDFC012	VKD-TKD-VXE-SXE-RV	27,45
3/4"	ENDFC034	VKD-TKD-VXE-SXE-RV	46,59
1"	ENDFC100	VKD-TKD-VXE-SXE-RV	49,34
1 1/4"	ENDFC114	VKD-TKD-VXE-SXE-RV	54,85
1 1/2"	ENDFC112	VKD-TKD-VXE-SXE-RV	60,31
2"	ENDFC200	VKD	68,58
2 1/2"	ENDFC212	VKD	82,25
3"	ENDFC300	VKD	120,66
3"	ENDFC300VXE	VXE-SXE	120,66
4"	ENDFC400	VKD	150,79
4"	ENDFC400VXE	VXE-SXE	150,79

Conector final en C-PVC.
H rosca GAS.



MANGUITO

d	Ref.	Para válvulas	€
1/2"	ENDAC012	VKD-TKD-VXE-SXE-RV	27,45
3/4"	ENDAC034	VKD-TKD-VXE-SXE-RV	46,59
1"	ENDAC100	VKD-TKD-VXE-SXE-RV	49,34
1 1/4"	ENDAC114	VKD-TKD-VXE-SXE-RV	54,85
1 1/2"	ENDAC112	VKD-TKD-VXE-SXE-RV	60,31
2"	ENDAC200	VKD-TKD-VXE-SXE-RV	68,58
2 1/2"	ENDAC212	VKD	82,25
3"	ENDAC300	VKD	120,66
3"	ENDAC300VXE	VXE-SXE	120,66
4"	ENDAC400	VKD	150,79
4"	ENDAC400VXE	VXE-SXE	150,79

Conector final en C-PVC.
H encolar serie ASTM.



MANGUITO

d	Ref.	Para válvulas	€
16	ENDDC016	VKD-TKD-VXE-SXE-RV	27,45
20	ENDDC020	VKD-TKD-VXE-SXE-RV	27,45
25	ENDDC025	VKD-TKD-VXE-SXE-RV	46,59
32	ENDDC032	VKD-TKD-VXE-SXE-RV	49,34
40	ENDDC040	VKD-TKD-VXE-SXE-RV	54,85
50	ENDDC050	VKD-TKD-VXE-SXE-RV	60,31
63	ENDDC063	VKD-TKD-VXE-SXE-RV	68,58
75	ENDDC075	VKD	82,25
90	ENDDC090	VKD	120,66
90	ENDDC090VXE	VXE-SSE	120,66
110	ENDDC110	VKD	150,79
110	ENDDC110VXE	VXE-SSE	150,79

Conector final en C-PVC.
M encolar.



MANGUITO

Rh	Ref.	Para válvulas	€
1/2"	ENDNC012	VKD-TKD-VXE-SXE-RV	27,45
3/4"	ENDNC034	VKD-TKD-VXE-SXE-RV	46,59
1"	ENDNC100	VKD-TKD-VXE-SXE-RV	49,34
1 1/4"	ENDNC114	VKD-TKD-VXE-SXE-RV	54,85
1 1/2"	ENDNC112	VKD-TKD-VXE-SXE-RV	60,31
2"	ENDNC200	VKD	68,58
2 1/2"	ENDNC212	VKD	82,25
3"	ENDNC300	VKD	120,66
3"	ENDNC300VXE	VXE-SXE	120,66
4"	ENDNC400	VKD	150,79
4"	ENDNC400VXE	VXE-SXE	150,79

Conector final en C-PVC.
H rosca NPT



0810

Accesorios mecánicos para la unión de tuberías

INDUSTRIA



Más información





Accesorios mecánicos





METAL GRIP

diámetro exterior	PN (bar)	PN (bar)	CARCASA EN ACERO GALVANIZADO				CARCASA EN ACERO INOXIDABLE			
			Ref. EPDM	€ EPDM	Ref. NBR	€ NBR	Ref. EPDM	€ EPDM	Ref. NBR	€ NBR
30,0	67,0	16,0	50	183,66	51	183,66	58	218,75	57	218,75
33,7	62,0	16,0	86	184,95	123	184,95	126	220,91	127	220,91
38,0	58,0	16,0	110	185,85	122	185,85	40100	220,91	40101	220,91
42,4	53,0	16,0	11045	187,34	11047	187,34	40150	223,08	40151	223,08
44,5	48,0	16,0	129	188,42	130	188,42	40200	223,08	40201	223,08
48,3	44,0	16,0	11048	191,27	11050	191,27	40250	225,27	40251	225,27
54,0	39,0	16,0	8669	192,33	8671	192,33	8668	227,43	8670	227,43
57,0	37,0	16,0	11052	193,85	11051	193,85	11043	229,60	11053	229,60
60,3	37,0	16,0	11054	197,52	11056	197,52	11044	231,75	11055	231,75
63,5	37,0	16,0	209	204,89	210	204,89	211	240,43	212	240,43
73,0	56,0	16,0	186	229,60	187	229,60	104105	272,93	192	272,93
76,1	56,0	16,0	215	233,92	155	233,92	40450	277,26	40451	277,26
84,0	45,0	16,0	216	249,10	156	249,10	104060	290,24	102278	290,24
88,9	41,0	16,0	135	251,23	157	251,23	40550	294,55	40551	294,55
104,0	37,0	16,0	136	279,39	158	279,39	173	318,40	197	318,40
108,0	35,0	16,0	137	283,72	159	283,72	40650	322,73	40651	322,73
114,3	34,0	16,0	138	296,76	160	296,76	40700	337,90	40701	337,90
129,0	33,0	16,0	139	400,70	161	400,70	40600	470,01	40601	470,01
133,0	33,0	16,0	140	411,54	162	411,54	40602	478,68	40603	478,68
139,7	32,0	16,0	141	457,01	163	457,01	40614	526,33	40611	526,33
154,0	32,0	16,0	142	502,50			40622	571,81		
159,0	31,0	16,0	143	508,99	165	508,99	40634	578,29	40631	578,29
168,3	29,0	16,0	144	541,47	166	541,47	40655	608,63	40652	608,63
180,0	29,0	16,0	1650	968,15	1651	968,15				
193,7	29,0	16,0	1537	991,96	1542	991,96				
200,0	28,0	15,0	1652	1.005,01	1653	1.005,01				
206,0	28,0	15,0	1641	1.015,82	1654	1.015,82				
219,1	26,0	16,0	145	1.080,78	167	1.080,78	41050	1.208,56	41051	1.208,56
244,5	27,0	14,0	1572	1.089,46	1573	1.089,46				
267,0	24,0	12,0	1574	1.130,58	1575	1.130,58				
273,0	21,0	12,0	1567	1.178,25	1568	1.178,25				
323,9	18,0	10,0	1576	1.241,06	1577	1.241,06				
355,6	17,0	8,0	1579	1.295,22	1578	1.295,22				
406,4	14,0	8,0	1607	1.405,69	1608	1.405,69				
457,2	8,0	6,0	1609	1.518,31	1610	1.518,31				
508,0	6,0	5,0	1611	1.637,44	1612	1.637,44				
558,8	6,0	4,5	1613	1.756,54	1614	1.756,54				
609,6	5,0	4,0	1615	1.875,68	1616	1.875,68				

Acoplamiento para tubos metálicos con anclaje axial.

Acoplamiento para muy alta presión de alta calidad.

Máximo rendimiento.



Junta: EPDM: -30°C hasta +100°C NBR: -20°C hasta +80°C

Fluido: EPDM: Todas las calidades de agua, aguas residuales, aire, sólidos y diversos productos químicos.

NBR: Agua, gas, aceite, combustible y otros hidrocarburos.



METAL GRIP FIRE FENCE

diámetro exterior	 PN (bar)	 PN (bar)	CARCASA EN ACERO GALVANIZADO			CARCASA EN ACERO INOXIDABLE				
			Ref. EPDM	€ EPDM	Ref. NBR	€ NBR	Ref. EPDM	€ EPDM	Ref. NBR	€ NBR
30,0	67,0	16,0	19299	294,56	19349	294,56	105039	327,05	105026	327,05
33,7	62,0	16,0	19300	296,76	19350	296,76	105040	329,21	105027	329,21
38,0	58,0	16,0	19301	298,89	19351	298,89	105041	331,39	105028	331,39
42,4	53,0	16,0	19302	301,07	19352	301,07	105042	335,71	105029	335,71
44,5	48,0	16,0	19303	301,07	19353	301,07	40206	335,71	105030	335,71
48,3	44,0	16,0	19304	303,22	19354	303,22	105043	337,90	105031	337,90
54,0	39,0	16,0	19305	307,56	19355	307,56	19405	346,56	19455	346,56
57,0	37,0	16,0	19306	307,56	19356	307,56	19406	346,56	19456	346,56
60,3	37,0	16,0	19307	311,89	19357	311,89	19407	350,90	19457	350,90
63,5	37,0	16,0	19433	314,08	19432	314,08	19430	353,03	19431	353,03
76,1	56,0	16,0	19308	355,22	19358	355,22	105044	394,19	105032	394,19
84,0	45,0	16,0	19309	370,40	19359	370,40	19551	411,55	19552	411,55
88,9	41,0	16,0	19310	372,53	19360	372,53	105045	413,69	105033	413,69
104,0	37,0	16,0	19311	400,70	19361	400,70	19571	444,04	19572	444,04
108,0	35,0	16,0	19312	402,85	19362	402,85	105046	446,18	105034	446,18
114,3	34,0	16,0	19314	428,85	19364	428,85	105047	467,84	105035	467,84
129,0	33,0	16,0	19315	589,15	19365	589,15	19585	658,44	19568	658,44
133,0	33,0	16,0	19316	597,80	19366	597,80	19594	667,10	19593	667,10
139,7	32,0	16,0	19317	690,94	19367	690,94	105048	760,24	105036	760,24
154,0	32,0	16,0	19318	764,59			19601	833,89		
159,0	31,0	16,0	19319	773,23	19369	773,23	19603	842,56	19604	842,56
168,3	29,0	16,0	19321	827,38	19371	827,38	105049	896,68	19635	896,68
219,1	26,0	16,0	19323	1.641,76	19373	1.641,76	105050	1.773,90	105038	1.773,90
244,5	27,0	14,0	19324	1.923,33	19378	1.923,33				
267,0	24,0	12,0	19325	1.986,15	19380	1.986,15				
273,0	21,0	12,0	19326	2.033,78	19379	2.033,78				
323,9	18,0	10,0	19327	2.139,93	19381	2.139,93				
355,6	17,0	8,0	19328	2.239,57	19383	2.239,57				
406,4	14,0	8,0	19329	2.414,99	19384	2.414,99				
457,2	8,0	6,0	19330	2.601,27	19385	2.601,27				

Acoplamiento para tubos metálicos con anclaje axial y con protección al fuego.

Acoplamientos para muy alta presión de alta calidad.

Máximo rendimiento.

Junta: EPDM: -30°C hasta +100°C NBR: -20°C hasta +80°C

Fluido: EPDM: Todas las calidades de agua, aguas residuales, aire, sólidos y diversos productos químicos.

NBR: Agua, gas, aceite, combustible y otros hidrocarburos.



GRIP

CARCASA EN ACERO INOXIDABLE

diámetro exterior	PN (bar)	PN (bar)	Ref. EPDM	€ EPDM	Ref. NBR	€ NBR	Ref. FKM	€ FKM
25,0	64,0	16,0	G20041	80,16	G20040	80,16	G20043	174,99
26,9	58,0	16,0	G20000	81,43	G20001	81,43	G20011	176,29
28,0	50,0	16,0	G20025	82,30	G20026	82,30	G20027	177,18
30,0	42,0	16,0	G20050	83,62	G20051	83,62	G20054	178,49
33,7	39,0	16,0	G20100	86,18	G20101	86,18	G20110	178,49
35,0	37,0	16,0	G20124	90,31	G20125	90,31	G20126	178,49
38,0	36,0	16,0	G20150	99,63	G20151	99,63	G20164	178,49
40,0	35,0	16,0	G20175	100,92	G20176	100,92	G20177	179,58
42,4	33,0	16,0	G20200	102,46	G20201	102,46	G20206	180,63
44,5	30,0	16,0	G20250	104,84	G20251	104,84	G20253	180,63
48,3	28,0	16,0	G20300	107,45	G20301	107,45	G20306	183,02
54,0	24,0	16,0	G20350	120,42	G20351	120,42	G20360	183,02
57,0	23,0	16,0	G20400	123,45	G20401	123,45	G20406	187,34
60,3	23,0	16,0	G20450	125,89	G20451	125,85	G20456	191,91
63,0	23,0	16,0	G20425	137,98	G20426	137,98	G20427	211,82
66,6	22,0	16,0	G20470	154,20	G20471	154,20	G20476	238,24
70,0	22,0	16,0	G20485	156,58	G20486	156,58	G20494	240,43
73,0	21,0	16,0	G20500	160,50	G20501	160,50	G20506	240,43
76,1	35,0	16,0	G20550	164,00	G20551	163,96	G20558	244,74
79,5	32,0	16,0	G20570	166,98	G20583	166,98	G20584	247,56
84,0	29,0	16,0	G20600	171,75	G20601	171,75	G20606	249,10
88,9	26,0	16,0	G20650	176,77	G20651	176,74	G20656	255,58
95,0	24,0	16,0	G20667	180,21	G20677	180,21	G20678	259,92
98,0	24,0	16,0	G20690	181,90	G20691	181,90	G20692	259,92
100,6	23,0	16,0	G20700	183,44	G20701	183,44	G20706	262,06
101,6	23,0	16,0	G20750	184,12	G20751	184,12		
104,0	23,0	16,0	G20800	184,12	G20801	184,12		
104,8	23,0	16,0	G20825	186,07	G20826	186,07		
108,0	22,0	16,0	G20850	189,96	G20851	189,96	G20865	264,28
114,3	22,0	16,0	G20900	195,63	G20901	195,59	G20906	268,59
118,0	22,0	16,0	G20930	198,83	G20931	198,83	G20932	270,73
125,0	21,0	16,0	G20940	277,25	G20941	277,25	G20942	290,24

Acoplamiento para tubos metálicos con anclaje axial.

Acoplamiento para alta presión de alta calidad.

Continúa en la página siguiente...

diámetro exterior	PN (bar)	PN (bar)	CARCASA EN ACERO INOXIDABLE					
			Ref. EPDM	€ EPDM	Ref. NBR	€ NBR	Ref. FKM	€ FKM
127,0	21,0	16,0	G20950	279,39	G20951	279,39	G20957	298,89
129,0	21,0	16,0	G21000	281,57	G21001	281,57	G21006	311,89
130,2	21,0	16,0	G21050	281,57	G21051	281,57	G21052	318,40
133,0	21,0	16,0	G21100	283,72	G21101	283,72	G21112	337,90
139,7	20,0	16,0	G21150	290,30	G21151	290,30	G21165	379,05
141,3	20,0	16,0	G21200	292,39	G21201	292,39	G21208	387,70
144,0	20,0	16,0	G21225	294,56	G21226	294,56	G21227	405,04
154,0	18,0	16,0	G21250	301,07	G21251	301,07	G21262	467,84
159,0	18,0	16,0	G21300	305,40	G21301	305,40	G21309	500,32
165,0	16,0	16,0	G21328	311,89	G21326	311,89	G21331	537,12
168,3	16,0	16,0	G21350	314,13	G21351	314,08	G21369	558,81
219,1	16,0	10,0	21400	550,13	21401	550,13	21408	725,57
180,0	16,0	10,0	24950	771,04	24952	771,04	24955	818,71
193,7	16,0	10,0	25000	790,54	25002	790,54	25007	836,02
200,0	15,0	10,0	25010	799,20	25012	799,20	25015	844,67
204,0	14,0	10,0	25050	801,41	25052	801,41	25049	851,22
206,0	14,0	5,5	25058	801,41	25068	801,41	25072	851,22
244,5	9,0	5,5	25100	818,71	25102	818,71	25106	875,04
250,0	9,0	5,5	25110	823,05	25112	823,05	25115	888,03
254,0	9,0	5,5	25125	827,38	25127	827,38	25131	896,68
256,0	9,0	5,5	25140	827,38	25143	827,38	25145	896,68
267,0	8,0	5,0	25150	836,02	25152	836,02	25157	924,86
273,0	7,0	4,0	25200	838,21	25202	838,21	25207	937,84
306,0	6,0	3,0	25260	862,05	25263	862,05	25265	1.005,01
323,9	5,0	3,0	25300	881,50	25302	881,50	25309	1.048,29
355,6	10,0	2,5	25353	924,86	25352	924,86	25351	1.464,16
406,4	7,0	2,0	25413	989,83	25403	989,83	25402	1.565,96
457,2	5,0		25434	1.059,14	25435	1.059,14	25436	1.678,59
508,0	4,0		25453	1.124,11	25452	1.124,11	25462	1.778,25
558,8	3,0		25483	1.191,26	25484	1.191,26	25485	1.886,51
609,6	2,0		25517	1.256,24	25518	1.256,24	25519	1.994,83
711,2	1,0		26001	1.392,67	26002	1.392,67	26003	2.211,41

Junta: EPDM: -20°C hasta +100°C NBR: -20°C hasta +80°C FKM: -20°C hasta +180°C

Fluido: EPDM: Todas las calidades de agua, aguas residuales, aire, sólidos y diversos productos químicos.



NBR: Agua, gas, aceite, combustible y otros hidrocarburos.

FKM: Ozono, oxígeno, ácidos, gas, aceite y carburantes.



GRIP

CARCASA EN ACERO GALVANIZADO

diámetro exterior	 PN (bar)	 PN (bar)	Ref. EPDM	€ EPDM	Ref. NBR	€ NBR	Ref. FKM	€ FKM
180,0	16,0	10,0	24951	703,94	24953	703,94	24954	751,59
193,7	16,0	10,0	25001	723,41	25003	723,41	25006	768,91
200,0	15,0	10,0	25011	732,06	25013	732,06	25014	777,59
204,0	14,0	10,0	25051	734,22	25053	734,22	25048	786,22
206,0	14,0	5,5	25066	734,22	25067	734,22	25069	786,22
244,5	9,0	5,5	25101	751,59	25103	751,59	25105	807,88
250,0	9,0	5,5	25111	758,05	25113	758,05	25114	820,87
254,0	9,0	5,5	25126	760,24	25128	760,24	25132	829,56
256,0	9,0	5,5	25141	760,24	25142	760,24	25144	829,56
267,0	8,0	5,0	25151	768,91	25153	768,91	25156	859,86
273,0	7,0	4,0	25201	771,04	25203	771,04	25198	870,69
306,0	6,0	3,0	25261	794,88	25262	794,88	25264	937,84
323,9	5,0	3,0	25301	814,38	25303	814,38	25315	981,16
355,6	10,0	2,5	101099	859,86	101100	859,86	101101	1.373,20
406,4	7,0	2,0	101102	922,69	101103	922,69	101104	1.477,16
457,2	5,0		101105	991,96	101106	991,96	101107	1.587,64
508,0	4,0		101108	1.054,80	101109	1.054,80	101110	1.689,41
558,8	3,0		101111	1.124,11	101112	1.124,11	101113	1.797,69
609,6	2,0		101114	1.191,26	101115	1.191,26	101116	1.906,01
711,2	1,0		26000	1.327,72	101117	1.327,72	101118	2.122,61

Acoplamiento para tubos metálicos con anclaje axial.

Acoplamientos para alta presión de alta calidad.

Junta: EPDM: -20°C hasta +100°C NBR: -20°C hasta +80°C FKM: -20°C hasta +180°C

Fluido: EPDM: Todas las calidades de agua, aguas residuales, aire, sólidos y diversos productos químicos.

NBR: Agua, gas, aceite, combustible y otros hidrocarburos.

FKM: Ozono, oxígeno, ácidos, gas, aceite y carburantes.



GRIP FIRE FENCE

CARCASA EN ACERO INOXIDABLE

diámetro exterior	PN (bar)	PN (bar)	Ref. EPDM	€ EPDM	Ref. NBR	€ NBR	Ref. FKM	€ FKM
25,0	64,0	16,0	G20044	187,41	G20042	187,41	G20045	253,14
26,9	58,0	16,0	G20007	188,73	G20008	188,73	G20013	253,14
28,0	50,0	16,0	G20028	188,73	G20029	188,73	G20030	255,03
30,0	42,0	16,0	G20056	188,73	G20057	188,73	G20058	255,03
33,7	39,0	16,0	G20108	188,73	G20109	188,73	G20114	255,03
35,0	37,0	16,0	G20127	190,78	G20128	190,78	G20129	256,92
38,0	36,0	16,0	G20157	190,78	G20158	190,78	G20165	258,83
40,0	35,0	16,0	G20178	190,78	G20179	190,78	G20180	260,71
42,4	33,0	16,0	G20209	190,78	G20210	190,78	G20214	262,61
44,5	30,0	16,0	G20258	190,78	G20259	190,78	G20263	262,61
48,3	28,0	16,0	G20310	192,67	G20311	192,67	G20318	264,47
54,0	24,0	16,0	G20358	196,48	G20359	196,48	G20362	266,37
57,0	23,0	16,0	G20408	196,48	G20409	196,48	G20412	270,15
60,3	23,0	16,0	G20464	200,24	G20465	200,24	G20448	270,15
63,0	23,0	16,0	G20428	205,92	G20429	205,92	G20430	277,69
66,6	22,0	16,0	G20474	213,47	G20475	213,47	G20477	287,15
70,0	22,0	16,0	G20492	221,02	G20493	221,02	G20495	300,37
73,0	21,0	16,0	G20508	228,58	G20509	228,58	G20510	304,14
76,1	35,0	16,0	G20567	236,13	G20568	236,13	G20581	307,92
79,5	32,0	16,0	G20574	241,82	G20575	241,82	G20582	313,59
84,0	29,0	16,0	G20607	247,47	G20608	247,47	G20613	319,25
88,9	26,0	16,0	G20664	249,36	G20665	249,36	G20676	319,25
95,0	24,0	16,0	G20679	256,92	G20680	256,92	G20681	324,93
98,0	24,0	16,0	G20693	260,71	G20694	260,71	G20695	328,71
100,6	23,0	16,0	G20704	262,61	G20705	262,61	G20707	330,61
101,6	23,0	16,0	G20757	264,47	G20758	264,47	G20759	332,47
104,0	23,0	16,0	G20806	270,15	G20807	270,15	G20812	338,15
104,8	23,0	16,0	G20829	270,15	G20830	270,15	G20831	338,15
108,0	22,0	16,0	G20863	272,03	G20864	272,03	G20866	340,04
114,3	22,0	16,0	G20913	283,37	G20914	283,37	G20925	345,71

Acoplamiento para tubos metálicos
con anclaje axial y con protección al fuego.
Acoplamiento para alta presión de alta calidad.



Junta: EPDM: -20°C hasta +100°C NBR: -20°C hasta +80°C FKM: -20°C hasta +180°C
Fluido: EPDM: Todas las calidades de agua, aguas residuales, aire, sólidos y diversos productos químicos.
NBR: Agua, gas, aceite, combustible y otros hidrocarburos.
FKM: Ozono, oxígeno, ácidos, gas, aceite y carburantes.

Continúa en la página siguiente...



GRIP FIRE FENCE

CARCASA EN ACERO INOXIDABLE

diámetro exterior	 PN (bar)	 PN (bar)	Ref. EPDM	€ EPDM	Ref. NBR	€ NBR	Ref. FKM	€ FKM
118,0	22,0	16,0	G20933	290,96	G20934	290,96	G20935	349,49
125,0	21,0	16,0	G20943	353,28	G20944	353,28	G20945	364,62
127,0	21,0	16,0	G20954	368,36	G20955	368,36	G20958	387,29
129,0	21,0	16,0	G21004	383,48	G21005	383,48	G21007	409,97
130,2	21,0	16,0	G21054	391,06	G21055	391,06	G21056	426,96
133,0	21,0	16,0	G21106	409,97	G21107	409,97	G21113	459,08
139,7	20,0	16,0	G21156	457,16	G21157	457,16	G21169	534,62
141,3	20,0	16,0	G21206	468,49	G21207	468,49	G21209	555,43
144,0	20,0	16,0	G21228	474,19	G21229	474,19	G21230	572,40
154,0	18,0	16,0	G21256	493,04	G21257	493,04	G21264	638,53
159,0	18,0	16,0	G21306	498,75	G21307	498,75	G21312	666,86
165,0	16,0	16,0	G21329	515,73	G21330	515,73	G21332	712,22
168,3	16,0	16,0	G21358	525,18	G21359	525,18	G21377	736,74
219,1	16,0	10,0	21409	971,00	21410	971,00	21418	1.122,12
180,0	16,0	10,0	24957	1.348,85	24958	1.348,85	24960	1.388,50
193,7	16,0	10,0	24997	1.367,73	25008	1.367,73	24999	1.409,29
200,0	15,0	10,0	25018	1.377,19	25019	1.377,19	25021	1.418,73
204,0	14,0	10,0	25044	1.384,74	25045	1.384,74	25047	1.430,08
206,0	14,0	5,5	25076	1.384,74	25077	1.384,74	25079	1.430,08
244,5	9,0	5,5	25096	1.441,40	25097	1.441,40	25099	1.490,55
250,0	9,0	5,5	25116	1.450,87	25117	1.450,87	25119	1.507,50
254,0	9,0	5,5	25133	1.456,52	25134	1.456,52	25136	1.516,98
256,0	9,0	5,5	25146	1.456,52	25147	1.456,52	25149	1.516,98
267,0	8,0	5,0	25159	1.475,40	25158	1.475,40	25163	1.552,87
273,0	7,0	4,0	25212	1.479,19	25211	1.479,19	25196	1.564,18
306,0	6,0	3,0	25268	1.509,42	25269	1.509,42	25271	1.634,12
323,9	5,0	3,0	25312	1.552,87	25314	1.552,87	25297	1.698,32
355,6	10,0	2,5	25359	1.630,32	25511	1.630,32	25349	2.098,84
406,4	7,0	2,0	25415	1.745,56	25412	1.745,56	25397	2.248,06

Acoplamiento para tubos metálicos con anclaje axial.

Acoplamiento para alta presión de alta calidad.

Junta: EPDM: -20°C hasta +100°C NBR: -20°C hasta +80°C FKM: -20°C hasta +180°C

Fluido: EPDM: Todas las calidades de agua, aguas residuales, aire, sólidos y diversos productos químicos.

NBR: Agua, gas, aceite, combustible y otros hidrocarburos.

FKM: Ozono, oxígeno, ácidos, gas, aceite y carburantes.



GRIP FIRE FENCE

CARCASA EN ACERO GALVANIZADO

diámetro exterior	PN (bar)	PN (bar)	Ref. EPDM	€ EPDM	Ref. NBR	€ NBR	Ref. FKM	€ FKM
180,0	16,0	10,0	24956	1.290,29	24961	1.290,29	24959	1.331,82
193,7	16,0	10,0	24995	1.309,15	24996	1.309,15	24998	1.350,76
200,0	15,0	10,0	25016	1.318,64	25017	1.318,64	25020	1.360,16
204,0	14,0	10,0	25042	1.326,20	25043	1.326,20	25046	1.371,50
206,0	14,0	5,5	25073	1.326,20	25074	1.326,20	25078	1.371,50
244,5	9,0	5,5	25094	1.382,85	25095	1.382,85	25098	1.431,96
250,0	9,0	5,5	25108	1.392,29	25109	1.392,29	25118	1.448,97
254,0	9,0	5,5	25123	1.399,86	25124	1.399,86	25135	1.460,31
256,0	9,0	5,5	25138	1.399,86	25139	1.399,86	25148	1.460,31
267,0	8,0	5,0	25160	1.416,85	25161	1.416,85	25162	1.494,33
273,0	7,0	4,0	25193	1.420,65	25194	1.420,65	25195	1.505,65
306,0	6,0	3,0	25266	1.450,87	25267	1.450,87	25270	1.575,56
323,9	5,0	3,0	25294	1.494,33	25295	1.494,33	25296	1.639,77
355,6	10,0	2,5	25346	1.571,73	25347	1.571,73	25348	2.021,36
406,4	7,0	2,0	25394	1.687,02	25395	1.687,02	25396	2.168,72

Acoplamiento para tubos metálicos con anclaje axial y **con protección al fuego**.
 Acoplamientos para alta presión de alta calidad.

Junta: EPDM: -20°C hasta +100°C NBR: -20°C hasta +80°C FKM: -20°C hasta +180°C
Fluido: EPDM: Todas las calidades de agua, aguas residuales, aire, sólidos y diversos productos químicos.
 NBR: Agua, gas, aceite, combustible y otros hidrocarburos.
 FKM: Ozono, oxígeno, ácidos, gas, aceite y carburantes.



COMBI-GRIP

diámetro exterior	PN (bar)	CARCASA EN ACERO GALVANIZADO				CARCASA EN ACERO INOXIDABLE			
		Ref. EPDM	€ EPDM	Ref. NBR	€ NBR	Ref. EPDM	€ EPDM	Ref. NBR	€ NBR
40,0 / 38,0	16,0	9130	206,19	9132	206,19	14800	238,25	14801	238,25
40,0 / 42,4	16,0	9120	206,19	9123	206,19	104274	238,25	14802	238,25
50,0 / 48,3	16,0	6768	211,62	6769	211,62	100602	244,75	104782	244,75
63,0 / 60,3	16,0	9114	218,73	9113	218,73	9399	251,23	9400	251,23
75,0 / 76,1	16,0	94	257,74	98	257,74	100605	298,89	101302	298,89
90,0 / 88,9	16,0	91	279,39	422	279,39	40458	318,40	420	318,40
110,0 / 108,0	16,0	424	311,89	426	311,89	101504	353,03	104793	353,03
110,0 / 114,3	16,0	14954	394,18	14956	394,18	100606	444,04	101041	444,04
114,3 / 114,3	16,0	428	327,06	430	327,06	442	368,21	443	368,21
140,0 / 139,7	16,0	432	506,81	434	506,81	40500	571,81	40501	571,81
160,0 / 159,0	16,0	436	563,13	438	563,13	40502	628,13	40503	628,13
160,0 / 168,3	16,0					102727	628,14	102726	628,14
200,0 / 206,0	16,0	102704	732,06	102705	732,06	101839	801,41	102196	801,41
225,0 / 219,1	10,0	102707	773,23	102708	773,23	102706	844,67	102709	844,67
225,0 / 229,0	10,0	102881	773,23	102880	773,23	102035	844,67	102879	844,67
250,0 / 256,0	10,0	102715	818,71	102713	818,71	102225	888,03	102712	888,03
315,0 / 323,9	10,0	102714	935,69	102716	935,69	102569	1.005,01	102717	1.005,01
355,0 / 355,6	6,0	102721	1.009,32	102720		102719	1.078,65	102718	1.078,65

Acoplamiento para transiciones

de tubos plásticos a metálicos con anclaje axial.

En tubos plásticos es necesario incorporar el anillo de refuerzo "stiffening ring".

Junta: EPDM: -20°C hasta +100°C NBR: -20°C hasta +80°C

Fluido: EPDM: Todas las calidades de agua, aguas residuales, aire, sólidos y diversos productos químicos.

NBR: Agua, gas, aceite, combustible y otros hidrocarburos.



FLEX 1

CARCASA EN ACERO GALVANIZADO

diámetro exterior	PN (bar)	PN (bar)	Ref. EPDM	€ EPDM	Ref. NBR	€ NBR	Ref. FKM (1)	€ FKM
48,3	25,0	16,0	30001	88,81	30003	88,81		
54,0	25,0	16,0	30051	90,96	30053	90,96		
57,0	25,0	16,0	30101	91,86	30103	91,86		
60,3	25,0	16,0	30151	94,01	30153	94,01	30162	178,49
70,0	25,0	16,0	30194	106,56	30191	106,56	30196	207,30
73,0	25,0	16,0	30201	107,45	30203	107,45	30208	209,69
76,1	25,0	16,0	30251	108,27	30253	108,27	30258	212,06
80,0	25,0	16,0					102951	214,65
84,0	25,0	16,0	30301	110,67	30303	110,67	30314	216,39
88,9	25,0	16,0	30351	112,19	30353	112,19	30364	218,73
100,6	25,0	16,0	30401	115,44	30403	115,44	30411	223,09
101,6	25,0	16,0	30451	115,66	30453	115,66	30460	223,09
104,0	20,0	16,0	30501	116,10	30503	116,10	30511	225,26
104,8	20,0	16,0	30551	116,54	30553	116,54	30559	225,26
108,0	20,0	16,0	30601	117,38	30603	117,38	30613	227,43
114,3	20,0	16,0	30651	118,48	30653	118,48	30658	227,43
127,0	20,0	16,0	30676	154,66	30678	154,66	30679	272,93
129,0	20,0	16,0	30701	155,95	30703	155,95	30715	275,07
130,2	20,0	16,0	30751	156,58	30753	156,58	30754	277,25
133,0	16,0	16,0	30801	158,54	30803	158,54	30812	279,39
139,7	16,0	16,0	30851	160,91	30853	160,91	30867	290,24
141,3	16,0	16,0	30901	161,99	30903	161,99	30909	292,39
154,0	16,0	16,0	30951	166,36	30953	166,36	30963	311,89
159,0	16,0	16,0	31001	168,92	31003	168,92	31016	318,40
168,3	16,0	16,0	31051	173,07	31053	173,07	31075	331,39

Acoplamiento para tubos de cualquier material sin anclaje axial.

Acoplamiento de unión y compensador todo en uno.

(1) acoplamiento con anillo interior en acero inoxidable incorporado.

Junta: EPDM: -20°C hasta +100°C NBR: -20°C hasta +80°C FKM: -20°C hasta +180°C

Fluido: EPDM: Todas las calidades de agua, aguas residuales, aire, sólidos y diversos productos químicos.



NBR: Agua, gas, aceite, combustible y otros hidrocarburos.

FKM: Ozono, oxígeno, ácidos, gas, aceite y carburantes.



FLEX 1

CARCARSA EN ACERO INOXIDABLE

diámetro exterior	 PN (bar)	 PN (bar)	Ref. EPDM	€ EPDM	Ref. NBR	€ NBR	Ref. FKM(1)	€ FKM
48,3	25,0	16,0	30000	122,80	30002	122,80		
54,0	25,0	16,0	30050	125,64	30052	125,64		
57,0	25,0	16,0	30100	126,69	30102	126,69		
60,3	25,0	16,0	30150	128,01	30152	128,01	30166	212,06
70,0	25,0	16,0	30193	141,43	30195	141,43	30197	242,57
73,0	25,0	16,0	30200	142,10	30202	142,10	30216	244,74
76,1	25,0	16,0	30250	142,74	30252	142,74	30266	246,89
80,0	25,0	16,0	30318	144,47				
84,0	24,0	16,0	30300	145,55	30302	145,55	30315	251,23
88,9	24,0	16,0	30350	146,86	30352	146,86	30366	253,42
100,6	23,0	16,0	30400	150,12	30402	150,12	30412	257,74
101,6	23,0	16,0	30450	150,30	30452	150,30	30461	257,74
104,0	22,0	16,0	30500	150,76	30502	150,76	30512	262,06
104,8	22,0	16,0	30550	150,95	30552	150,95	30560	262,06
108,0	22,0	16,0	30600	152,70	30602	152,70	30614	264,28
114,3	21,0	16,0	30650	153,78	30652	153,78	30666	264,28
127,0	19,0	16,0	30675	199,03	30677	199,03	30680	316,21
129,0	18,0	16,0	30700	200,32	30702	200,32	30716	318,40
130,2	18,0	16,0	30750	201,22	30752	201,22	30755	320,55
133,0	16,0	16,0	30800	202,50	30802	202,50	30813	322,73
139,7	16,0	16,0	30850	205,75	30852	205,75	30866	335,70
141,3	16,0	16,0	30900	206,19	30902	206,19	30908	337,90
154,0	16,0	16,0	30950	211,38	30952	211,38	30964	357,37
159,0	16,0	16,0	31000	213,76	31002	213,76	31017	363,88
168,3	16,0	16,0	31050	218,73	31052	218,73	31074	376,87

Acoplamiento para tubos de cualquier material sin anclaje axial.

Acoplamiento de unión y compensador todo en uno.

(1) acoplamiento con anillo interior en acero inoxidable incorporado.

Junta: EPDM: -20°C hasta +100°C NBR: -20°C hasta +80°C FKM: -20°C hasta +180°C

Fluido: EPDM: Todas las calidades de agua, aguas residuales, aire, sólidos y diversos productos químicos.

NBR: Agua, gas, aceite, combustible y otros hidrocarburos.

FKM: Ozono, oxígeno, ácidos, gas, aceite y carburantes.



FLEX 2 PN 2,5 PN Consultar

desde Ø exterior	hasta Ø exterior	Ref. EPDM	W1 CARCARSA GALVANIZADA. CIERRES GALVANIZADOS			W2 CARCARSA EN ACERO INOX. CIERRES GALVANIZADOS			W5 CARCARSA EN ACERO INOX. CIERRES EN ACERO INOX.		
			€ EPDM	€ NBR	€ FKM (1)	€ EPDM	€ NBR	€ FKM (1)	€ EPDM	€ NBR	€ FKM (1)
172,0	199,0					442,85	442,85	651,11	527,19	527,19	735,46
200,0	224,0					456,04	456,04	698,53	540,40	540,40	782,89
225,0	249,0					466,58	466,58	751,26	550,95	550,95	835,62
250,0	274,0					482,39	482,39	806,63	566,75	566,75	890,98

Continúa en la página siguiente...

desde Ø exterior	hasta Ø exterior	Ref. EPDM	W1 CARCASA GALVANIZADA. CIERRES GALVANIZADOS			W2 CARCASA EN ACERO INOX. CIERRES GALVANIZADOS			W5 CARCASA EN ACERO INOX. CIERRES EN ACERO INOX.		
			€ EPDM	€ NBR	€ FKM (1)	€ EPDM	€ NBR	€ FKM (1)	€ EPDM	€ NBR	€ FKM (1)
275,0	299,0	F2020275W1E	801,35	801,35	1.133,48	490,29	490,29	861,96	574,63	574,63	946,32
300,0	324,0	F2020300W1E	814,53	814,53	1.191,46	508,75	508,75	912,05	593,08	593,08	996,39
325,0	349,0	F2020325W1E	827,69	827,69	1.254,72	519,29	519,29	967,40	603,64	603,64	1.051,77
350,0	374,0	F2020350W1E	840,89	840,89	1.307,46	532,47	532,47	1.020,14	616,84	616,84	1.104,50
375,0	399,0	F2020375W1E	854,09	854,09	1.370,71	543,02	543,02	1.072,82	627,39	627,39	1.157,19
400,0	424,0	F2020400W1E	872,51	872,51	1.433,96	553,54	553,54	1.125,57	637,90	637,90	1.209,92
425,0	449,0	F2020425W1E	885,69	885,69	1.484,08	569,37	569,37	1.180,93	653,71	653,71	1.265,27
450,0	474,0	F2020450W1E	898,89	898,89	1.539,42	585,21	585,21	1.236,28	669,54	669,54	1.320,64
475,0	499,0	F2020475W1E	914,71	914,71	1.594,75	603,64	603,64	1.286,38	688,00	688,00	1.370,71
500,0	524,0	F2020500W1E	925,24	925,24	1.647,51	619,44	619,44	1.341,70	703,79	703,79	1.426,06
525,0	549,0	F2020525W1E	946,32	946,32	1.708,13	635,29	635,29	1.394,44	719,65	719,65	1.478,79
550,0	574,0	F2020550W1E	972,67	972,67	1.776,67	648,45	648,45	1.449,80	732,80	732,80	1.534,15
575,0	599,0	F2020575W1E	993,78	993,78	1.834,65	666,91	666,91	1.502,54	751,26	751,26	1.586,89
600,0	624,0	F2020600W1E	1.051,77	1.051,77	1.892,66	785,53	785,53	1.631,69	869,89	869,89	1.716,04
625,0	649,0	F2020625W1E	1.072,82	1.072,82	1.963,81	793,42	793,42	1.689,66	877,78	877,78	1.774,02
650,0	674,0	F2020650W1E	1.093,97	1.093,97	2.021,82	811,89	811,89	1.742,40	896,27	896,27	1.826,76
675,0	699,0	F2020675W1E	1.115,03	1.115,03	2.079,81	832,95	832,95	1.797,76	917,32	917,32	1.882,10
700,0	724,0	F2020700W1E	1.141,39	1.141,39	2.143,07	851,45	851,45	1.850,50	935,79	935,79	1.934,86
725,0	749,0	F2020725W1E	1.162,46	1.162,46	2.198,43	877,78	877,78	1.905,83	962,14	962,14	1.990,20
750,0	799,0	F2020750W1E	1.180,93	1.180,93	2.230,05	1.038,58	1.038,58	1.990,20	1.122,96	1.122,96	2.074,55
800,0	849,0	F2020800W1E	1.228,40	1.228,40	2.288,07	1.075,50	1.075,50	2.098,23	1.159,85	1.159,85	2.182,59
850,0	899,0	F2020850W1E	1.267,93	1.267,93	2.346,03	1.112,36	1.112,36	2.206,33	1.196,75	1.196,75	2.290,68
900,0	949,0	F2020900W1E	1.315,37	1.315,37	2.464,66	1.154,57	1.154,57	2.319,68	1.238,94	1.238,94	2.404,04
950,0	999,0	F2020950W1E	1.357,55	1.357,55	2.588,55	1.191,46	1.191,46	2.427,78	1.275,81	1.275,81	2.512,13
1.000,0	1.049,0	F2021000W1E	1.397,10	1.397,10	2.701,91	1.233,66	1.233,66	2.535,82	1.318,01	1.318,01	2.620,17
1.050,0	1.099,0	F2021050W1E	1.447,17	1.447,17	2.809,96	1.283,72	1.283,72	2.643,92	1.368,10	1.368,10	2.728,27
1.100,0	1.149,0	F2021100W1E	1.486,70	1.486,70	2.904,86	1.339,10	1.339,10	2.754,61	1.423,45	1.423,45	2.838,96
1.150,0	1.199,0	F2021150W1E	1.531,53	1.531,53	3.007,68	1.391,82	1.391,82	2.865,32	1.476,14	1.476,14	2.949,65
1.200,0	1.249,0	F2021200W1E	1.576,35	1.576,35	3.113,11	1.444,52	1.444,52	2.973,39	1.528,89	1.528,89	3.057,74
1.250,0	1.299,0	F2021250W1E	1.623,78	1.623,78	3.221,19	1.497,28	1.497,28	3.084,10	1.581,62	1.581,62	3.168,48
1.300,0	1.349,0	F2021300W1E	1.668,59	1.668,59	3.326,62	1.547,35	1.547,35	3.192,20	1.631,69	1.631,69	3.276,55
1.350,0	1.399,0	F2021350W1E	1.716,04	1.716,04	3.432,07	1.600,04	1.600,04	3.300,31	1.684,39	1.684,39	3.384,65
1.400,0	1.449,0	F2021400W1E	1.760,85	1.760,85	3.540,15	1.650,11	1.650,11	3.410,97	1.734,46	1.734,46	3.495,33
1.450,0	1.499,0	F2021450W1E	1.808,30	1.808,30	3.645,58	1.702,84	1.702,84	3.521,67	1.787,20	1.787,20	3.606,06
1.500,0	1.549,0	F2021500W1E	1.853,09	1.853,09	3.751,01	2.237,95	2.237,95	4.135,89	2.327,57	2.327,57	4.225,52
1.550,0	1.600,0	F2021550W1E	1.900,57	1.900,57	3.859,11	2.301,22	2.301,22	4.259,81	2.390,84	2.390,84	4.349,44
1.600,0	1.649,0	F2021600W1E	1.947,98	1.947,98	3.964,56	2.367,10	2.367,10	4.383,67	2.456,73	2.456,73	4.473,29
1.650,0	1.699,0	F2021650W1E	1.992,81	1.992,81	4.069,97	2.433,04	2.433,04	4.510,21	2.522,68	2.522,68	4.599,83
1.700,0	1.749,0	F2021700W1E	2.040,27	2.040,27	4.175,44	2.498,93	2.498,93	4.634,09	2.588,55	2.588,55	4.723,71
1.750,0	1.799,0	F2021750W1E	2.085,09	2.085,09	4.280,87	2.562,22	2.562,22	4.760,62	2.651,86	2.651,86	4.850,25
1.800,0	1.849,0	F2021800W1E	2.132,50	2.132,50	4.386,30	2.628,10	2.628,10	4.884,51	2.717,73	2.717,73	4.974,14
1.850,0	1.899,0	F2021850W1E	2.177,32	2.177,32	4.494,38	2.693,98	2.693,98	5.008,41	2.783,62	2.783,62	5.098,03
1.900,0	1.949,0	F2021900W1E	2.224,79	2.224,79	4.599,83	2.757,28	2.757,28	5.134,93	2.846,90	2.846,90	5.224,56
1.950,0	1.999,0	F2021950W1E	2.269,60	2.269,60	4.705,27	2.823,16	2.823,16	5.258,82	2.912,79	2.912,79	5.348,46
2.000,0	2.032,0	F2022000W1E	2.317,04	2.317,04	4.810,71	2.889,05	2.889,05	5.382,69	2.978,65	2.978,65	5.472,32

Acoplamiento para tubos de cualquier material sin anclaje axial.

Acoplamiento de unión y compensador todo en uno.

Código W1 en NBR termina W1N
Código W1 en FKM termina W1F

Código W2 en EPDM termina W2E
Código W2 en NBR termina W2N
Código W2 en FKM termina W2F

Código W5 en EPDM termina W5E
Código W5 en NBR termina W5N
Código W5 en FKM termina W5F

(1) Los acoplamientos con la junta en FKM llevan incluido un anillo interior en acero inoxidable.

En caso de pedido indicar el diámetro exterior exacto.

Junta: EPDM: -20°C hasta +100°C NBR: -20°C hasta +80°C FKM: -20°C hasta +180°C

Fluido: EPDM: Todas las calidades de agua, aguas residuales, aire, sólidos y diversos productos químicos.

NBR: Agua, gas, aceite, combustible y otros hidrocarburos.

FKM: Ozono, oxígeno, ácidos, gas, aceite y carburantes.

Especificar 1 o 2 cierres

FLEX 2 PN 6

 Consultar

desde Ø exterior	hasta Ø exterior	Ref. EPDM	W1 CARCASA GALVANIZADA. CIERRES GALVANIZADOS			W2 CARCASA EN ACERO INOX. CIERRES GALVANIZADOS			W5 CARCASA EN ACERO INOX. CIERRES EN ACERO INOX.		
			€ EPDM	€ NBR	€ FKM (1)	€ EPDM	€ NBR	€ FKM (1)	€ EPDM	€ NBR	€ FKM (1)
172,0	199,0					442,85	442,85	651,11	527,19	527,19	735,46
200,0	224,0					456,04	456,04	698,53	540,40	540,40	782,89
225,0	249,0					466,58	466,58	751,26	550,95	550,95	835,62
250,0	274,0					482,39	482,39	806,63	566,75	566,75	890,98
275,0	299,0	F2060275W1E	801,35	801,35	1.133,48	490,29	490,29	861,96	574,63	574,63	946,32
300,0	324,0	F2060300W1E	814,53	814,53	1.191,46	508,75	508,75	912,05	593,08	593,08	996,39
325,0	349,0	F2060325W1E	827,69	827,69	1.254,72	519,29	519,29	967,40	603,64	603,64	1.051,77
350,0	374,0	F2060350W1E	840,89	840,89	1.307,46	532,47	532,47	1.020,14	616,84	616,84	1.104,50
375,0	399,0	F2060375W1E	854,09	854,09	1.370,71	543,02	543,02	1.072,82	627,39	627,39	1.157,19
400,0	424,0	F2060400W1E	872,51	872,51	1.433,96	553,54	553,54	1.125,57	637,90	637,90	1.209,92
425,0	449,0	F2060425W1E	885,69	885,69	1.484,08	569,37	569,37	1.180,93	653,71	653,71	1.265,27
450,0	474,0	F2060450W1E	898,89	898,89	1.539,42	585,21	585,21	1.236,28	669,54	669,54	1.320,64
475,0	499,0	F2060475W1E	914,71	914,71	1.594,75	603,64	603,64	1.286,38	688,00	688,00	1.370,71
500,0	524,0	F2060500W1E	925,24	925,24	1.647,51	619,44	619,44	1.341,70	703,79	703,79	1.426,06
525,0	549,0	F2060525W1E	946,32	946,32	1.708,13	698,53	698,53	1.468,26	782,89	782,89	1.552,60
550,0	574,0	F2060550W1E	972,67	972,67	1.776,67	714,32	714,32	1.523,59	798,70	798,70	1.607,95
575,0	599,0	F2060575W1E	993,78	993,78	1.834,65	732,80	732,80	1.576,35	817,15	817,15	1.660,69
600,0	624,0	F2060600W1E	1.051,77	1.051,77	1.892,66	1.001,68	1.001,68	1.842,57	1.091,30	1.091,30	1.932,20
625,0	649,0	F2060625W1E	1.072,82	1.072,82	1.963,81	1.014,87	1.014,87	1.905,83	1.104,50	1.104,50	1.995,46
650,0	674,0	F2060650W1E	1.093,97	1.093,97	2.021,82	1.038,58	1.038,58	1.969,09	1.128,22	1.128,22	2.058,70
675,0	699,0	F2060675W1E	1.115,03	1.115,03	2.079,81	1.067,56	1.067,56	2.029,74	1.157,19	1.157,19	2.119,37
700,0	724,0	F2060700W1E	1.141,39	1.141,39	2.143,07	1.091,30	1.091,30	2.092,96	1.180,93	1.180,93	2.182,59
725,0	749,0	F2060725W1E	1.162,46	1.162,46	2.198,43	1.120,30	1.120,30	2.158,90	1.209,92	1.209,92	2.248,54
750,0	799,0	F2060750W1E	1.180,93	1.180,93	2.230,05	1.331,16	1.331,16	2.253,80	1.420,78	1.420,78	2.343,42
800,0	849,0	F2060800W1E	1.228,40	1.228,40	2.288,07	1.375,99	1.375,99	2.377,69	1.465,59	1.465,59	2.467,31

Acoplamiento para tubos de cualquier material sin anclaje axial.

Acoplamiento de unión y compensador todo en uno.

Código W1 en NBR termina W1N
Código W1 en FKM termina W1F

Código W2 en EPDM termina W2E
Código W2 en NBR termina W2N
Código W2 en FKM termina W2F

Código W5 en EPDM termina W5E
Código W5 en NBR termina W5N
Código W5 en FKM termina W5F

Continúa en la página siguiente...

desde Ø exterior	hasta Ø exterior	Ref. EPDM	W1 CARCASA GALVANIZADA. CIERRES GALVANIZADOS			W2 CARCASA EN ACERO INOX. CIERRES GALVANIZADOS			W5 CARCASA EN ACERO INOX. CIERRES EN ACERO INOX.		
			€ EPDM	€ NBR	€ FKM (1)	€ EPDM	€ NBR	€ FKM (1)	€ EPDM	€ NBR	€ FKM (1)
850,0	899,0	F2060850W1E	1.267,93	1.267,93	2.346,03	1.426,06	1.426,06	2.504,21	1.515,69	1.515,69	2.593,84
900,0	949,0	F2060900W1E	1.315,37	1.315,37	2.464,66	1.476,14	1.476,14	2.628,10	1.565,77	1.565,77	2.717,73
950,0	999,0	F2060950W1E	1.357,55	1.357,55	2.588,55	1.526,27	1.526,27	2.754,61	1.615,89	1.615,89	2.844,24
1.000,0	1.049,0	F2061000W1E	1.397,10	1.397,10	2.701,91	1.576,35	1.576,35	2.881,17	1.665,98	1.665,98	2.970,79
1.050,0	1.099,0	F2061050W1E	1.447,17	1.447,17	2.809,96	1.642,24	1.642,24	3.005,07	1.731,87	1.731,87	3.094,69
1.100,0	1.149,0	F2061100W1E	1.486,70	1.486,70	2.904,86	1.713,39	1.713,39	3.131,57	1.803,03	1.803,03	3.221,19
1.150,0	1.199,0	F2061150W1E	1.531,53	1.531,53	3.007,68	1.781,94	1.781,94	3.258,09	1.871,56	1.871,56	3.347,71
1.200,0	1.249,0	F2061200W1E	1.576,35	1.576,35	3.113,11				3.112,93	3.112,93	6.028,72
1.250,0	1.299,0	F2061250W1E	1.623,78	1.623,78	3.221,19				3.193,58	3.193,58	6.210,94
1.300,0	1.349,0	F2061300W1E	1.668,59	1.668,59	3.326,62				3.277,26	3.277,26	6.393,17
1.350,0	1.399,0	F2061350W1E	1.716,04	1.716,04	3.432,07				3.363,88	3.363,88	6.578,40
1.400,0	1.449,0	F2061400W1E	1.760,85	1.760,85	3.540,15				3.450,52	3.450,52	6.766,60
1.450,0	1.499,0	F2061450W1E	1.808,30	1.808,30	3.645,58				3.543,13	3.543,13	6.957,79
1.500,0	1.549,0	F2061500W1E	1.853,09	1.853,09	3.751,01				3.632,76	3.632,76	7.152,00
1.550,0	1.600,0	F2061550W1E	1.900,57	1.900,57	3.859,11				3.728,37	3.728,37	7.346,20
1.600,0	1.649,0	F2061600W1E	1.947,98	1.947,98	3.964,56				3.823,96	3.823,96	7.546,34
1.650,0	1.699,0	F2061650W1E	1.992,81	1.992,81	4.069,97				3.925,54	3.925,54	7.746,50
1.700,0	1.749,0	F2061700W1E	2.040,27	2.040,27	4.175,44				4.027,08	4.027,08	7.946,67
1.750,0	1.799,0	F2061750W1E	2.085,09	2.085,09	4.280,87				4.134,66	4.134,66	8.155,78
1.800,0	1.849,0	F2061800W1E	2.132,50	2.132,50	4.386,30				4.505,11	4.505,11	8.624,80
1.850,0	1.899,0	F2061850W1E	2.177,32	2.177,32	4.494,38				4.624,59	4.624,59	8.842,93
1.900,0	1.949,0	F2061900W1E	3.197,47	3.197,47	5.575,17				4.747,09	4.747,09	9.066,98
1.950,0	1.999,0	F2061950W1E	3.263,36	3.263,36	5.699,04				4.875,56	4.875,56	9.297,01
2.000,0	2.032,0	F2062000W1E	3.329,30	3.329,30	5.822,91				5.004,00	5.004,00	9.524,07

Código W1 en NBR termina W1N
Código W1 en FKM termina W1F

Código W2 en EPDM termina W2E
Código W2 en NBR termina W2N
Código W2 en FKM termina W2F

Código W5 en EPDM termina W5E
Código W5 en NBR termina W5N
Código W5 en FKM termina W5F

(1) Los acoplamientos con la junta en FKM llevan incluido un anillo interior en acero inoxidable.
En caso de pedido indicar el diámetro exterior exacto.

Junta: EPDM: -20°C hasta +100°C NBR: -20°C hasta +80°C FKM: -20°C hasta +180°C
Fluido: EPDM: Todas las calidades de agua, aguas residuales, aire, sólidos y diversos productos químicos.
NBR: Agua, gas, aceite, combustible y otros hidrocarburos.
FKM: Ozono, oxígeno, ácidos, gas, aceite y carburantes.

Especificar 1 o 2 cierres

FLEX 2 PN 10
 PN
  Consultar

desde Ø exterior	hasta Ø exterior	Ref. EPDM	W1 CARCASA GALVANIZADA. CIERRES GALVANIZADOS			W2 CARCASA EN ACERO INOX. CIERRES GALVANIZADOS			W5 CARCASA EN ACERO INOX. CIERRES EN ACERO INOX.		
			€ EPDM	€ NBR	€ FKM (1)	€ EPDM	€ NBR	€ FKM (1)	€ EPDM	€ NBR	€ FKM (1)
172,0	199,0					442,85	442,85	651,11	527,19	527,19	735,46
200,0	224,0					456,04	456,04	698,53	540,40	540,40	782,89
225,0	249,0					466,58	466,58	751,26	550,95	550,95	835,62
250,0	274,0					482,39	482,39	806,63	566,75	566,75	890,98
275,0	299,0	F2100275W1E	801,35	801,35	1.133,48	543,02	543,02	922,60	627,39	627,39	1.006,94
300,0	324,0	F2100300W1E	814,53	814,53	1.191,46	556,21	556,21	977,94	640,55	640,55	1.062,30
325,0	349,0	F2100325W1E	827,69	827,69	1.254,72	569,37	569,37	1.030,67	653,71	653,71	1.115,03
350,0	374,0	F2100350W1E	840,89	840,89	1.307,46	748,62	748,62	1.215,20	838,25	838,25	1.304,81
375,0	399,0	F2100375W1E	854,09	854,09	1.370,71	761,80	761,80	1.278,46	851,45	851,45	1.368,10
400,0	424,0	F2100400W1E	872,51	872,51	1.433,96	780,25	780,25	1.341,70	869,89	869,89	1.431,34
425,0	449,0	F2100425W1E	885,69	885,69	1.484,08	803,95	803,95	1.405,00	893,58	893,58	1.494,60
450,0	474,0	F2100450W1E	898,89	898,89	1.539,42	825,09	825,09	1.465,59	914,71	914,71	1.555,22
475,0	499,0	F2100475W1E	914,71	914,71	1.594,75	848,77	848,77	1.528,89	938,40	938,40	1.618,51
500,0	524,0	F2100500W1E	925,24	925,24	1.647,51	869,89	869,89	1.592,16	959,52	959,52	1.681,78
525,0	549,0	F2100525W1E	946,32	946,32	1.708,13	896,27	896,27	1.655,39	985,87	985,87	1.745,00
550,0	574,0	F2100550W1E	972,67	972,67	1.776,67	914,71	914,71	1.718,67	1.004,32	1.004,32	1.808,30
575,0	599,0	F2100575W1E	993,78	993,78	1.834,65	938,40	938,40	1.781,94	1.028,02	1.028,02	1.871,56
600,0	624,0	F2100600W1E	1.051,77	1.051,77	1.892,66	1.001,68	1.001,68	1.842,57	1.091,30	1.091,30	1.932,20
625,0	649,0	F2100625W1E	1.072,82	1.072,82	1.963,81	1.014,87	1.014,87	1.905,83	1.104,50	1.104,50	1.995,46
650,0	674,0	F2100650W1E	1.093,97	1.093,97	2.021,82	1.038,58	1.038,58	1.969,09	1.128,22	1.128,22	2.058,70
675,0	699,0	F2100675W1E	1.115,03	1.115,03	2.079,81	1.067,56	1.067,56	2.029,74	1.157,19	1.157,19	2.119,37
700,0	724,0	F2100700W1E	1.141,39	1.141,39	2.143,07	1.091,30	1.091,30	2.092,96	1.180,93	1.180,93	2.182,59
725,0	749,0	F2100725W1E	1.162,46	1.162,46	2.198,43				2.407,93	2.407,93	4.319,87
750,0	799,0	F2100750W1E	1.180,93	1.180,93	2.230,05				2.443,76	2.443,76	4.457,30
800,0	849,0	F2100800W1E	1.228,40	1.228,40	2.288,07				2.485,55	2.485,55	4.600,69

Acoplamiento para tubos de cualquier material sin anclaje axial.

Acoplamiento de unión y compensador todo en uno.

Código W1 en NBR termina W1N
Código W1 en FKM termina W1F

Código W2 en EPDM termina W2E
Código W2 en NBR termina W2N
Código W2 en FKM termina W2F

Código W5 en EPDM termina W5E
Código W5 en NBR termina W5N
Código W5 en FKM termina W5F

Continúa en la página siguiente...

desde Ø exterior	hasta Ø exterior	Ref. EPDM	W1 CARCASA GALVANIZADA. CIERRES GALVANIZADOS			W2 CARCASA EN ACERO INOX. CIERRES GALVANIZADOS			W5 CARCASA EN ACERO INOX. CIERRES EN ACERO INOX.		
			€ EPDM	€ NBR	€ FKM (1)	€ EPDM	€ NBR	€ FKM (1)	€ EPDM	€ NBR	€ FKM (1)
850,0	899,0	F2100850W1E	1.267,93	1.267,93	2.346,03				2.527,39	2.527,39	4.738,13
900,0	949,0	F2100900W1E	1.315,37	1.315,37	2.464,66				2.736,50	2.736,50	5.048,81
950,0	999,0	F2100950W1E	1.357,55	1.357,55	2.588,55				2.775,37	2.775,37	5.189,23
1.000,0	1.049,0	F2101000W1E	2.027,08	2.027,08	3.331,92				2.811,23	2.811,23	5.326,64
1.050,0	1.099,0	F2101050W1E	2.098,23	2.098,23	3.461,08				2.859,02	2.859,02	5.470,04
1.100,0	1.149,0	F2101100W1E	2.158,90	2.158,90	3.577,04				2.984,48	2.984,48	5.703,06
1.150,0	1.199,0	F2101150W1E	2.222,13	2.222,13	3.698,31				3.041,25	3.041,25	5.855,41
1.200,0	1.249,0	F2101200W1E	2.285,41	2.285,41	3.822,21						
1.250,0	1.299,0	F2101250W1E	2.351,30	2.351,30	3.948,73						
1.300,0	1.349,0	F2101300W1E	2.417,21	2.417,21	4.072,63						
1.350,0	1.399,0	F2101350W1E	2.480,47	2.480,47	4.196,51						
1.400,0	1.449,0	F2101400W1E	2.546,37	2.546,37	4.325,69						
1.450,0	1.499,0	F2101450W1E	2.612,29	2.612,29	4.449,58						
1.500,0	1.549,0	F2101500W1E	2.678,18	2.678,18	4.576,11						
1.550,0	1.600,0	F2101550W1E	2.741,47	2.741,47	4.700,00						
1.600,0	1.649,0	F2101600W1E	2.807,35	2.807,35	4.823,89						
1.650,0	1.699,0	F2101650W1E	2.873,24	2.873,24	4.950,40						
1.700,0	1.749,0	F2101700W1E	2.936,50	2.936,50	5.074,30						
1.750,0	1.799,0	F2101750W1E	3.002,39	3.002,39	5.198,21						
1.800,0	1.849,0	F2101800W1E	3.068,30	3.068,30	5.324,70						
1.850,0	1.899,0	F2101850W1E	3.134,19	3.134,19	5.448,58						
1.900,0	1.949,0	F2101900W1E	3.197,47	3.197,47	5.575,17						
1.950,0	1.999,0	F2101950W1E	3.263,36	3.263,36	5.699,04						
2.000,0	2.032,0	F2102000W1E	3.329,30	3.329,30	5.822,91						

Código W1 en NBR termina W1N

Código W1 en FKM termina W1F

Código W5 en EPDM termina W5E

Código W5 en NBR termina W5N

Código W5 en FKM termina W5F

(1) Los acoplamientos con la junta en FKM llevan incluido un anillo interior en acero inoxidable.

En caso de pedido indicar el diámetro exterior exacto.

Junta: EPDM: -20°C hasta +100°C NBR: -20°C hasta +80°C FKM: -20°C hasta +180°C

Fluido: EPDM: Todas las calidades de agua, aguas residuales, aire, sólidos y diversos productos químicos.

NBR: Agua, gas, aceite, combustible y otros hidrocarburos.

FKM: Ozono, oxígeno, ácidos, gas, aceite y carburantes.

Especificar 1 o 2 cierres

FLEX 2 PN 16

 PN
 
 Consultar

desde Ø exterior	hasta Ø exterior	Ref. EPDM	W1 CARCASA GALVANIZADA. CIERRES GALVANIZADOS			W2 CARCASA EN ACERO INOX. CIERRES GALVANIZADOS			W5 CARCASA EN ACERO INOX. CIERRES EN ACERO INOX.		
			€ EPDM	€ NBR	€ FKM (1)	€ EPDM	€ NBR	€ FKM (1)	€ EPDM	€ NBR	€ FKM (1)
172,0	199,0					723,33	723,33	709,07	569,37	569,37	793,42
200,0	224,0					771,75	771,75	756,53	587,84	587,84	840,88
225,0	249,0					919,62	919,62	901,50	748,62	748,62	991,13
250,0	274,0					984,18	984,18	964,78	769,75	769,75	1.054,41
275,0	299,0	F2160275W1E	801,35	801,35	1.133,48	695,90	695,90	1.025,40	785,53	785,53	1.115,03
300,0	324,0	F2160300W1E	814,53	814,53	1.191,46	714,32	714,32	1.091,30	803,95	803,95	1.180,93
325,0	349,0	F2160325W1E	827,69	827,69	1.254,72	727,51	727,51	1.154,57	817,15	817,15	1.244,20
350,0	374,0	F2160350W1E	840,89	840,89	1.307,46	748,62	748,62	1.215,20	838,25	838,25	1.304,81
375,0	399,0	F2160375W1E	854,09	854,09	1.370,71	761,80	761,80	1.278,46	851,45	851,45	1.368,10
400,0	424,0	F2160400W1E	872,51	872,51	1.433,96	780,25	780,25	1.341,70	869,89	869,89	1.431,34
425,0	449,0	F2160425W1E	885,69	885,69	1.484,08				2.082,26	2.082,26	3.393,77
450,0	474,0	F2160450W1E	898,89	898,89	1.539,42				2.106,17	2.106,17	3.465,46
475,0	499,0	F2160475W1E	914,71	914,71	1.594,75				2.124,10	2.124,10	3.531,17
500,0	524,0	F2160500W1E	925,24	925,24	1.647,51				2.142,02	2.142,02	3.602,89
525,0	549,0	F2160525W1E	946,32	946,32	1.708,13				2.159,95	2.159,95	3.671,61
550,0	574,0	F2160550W1E	972,67	972,67	1.776,67				2.177,85	2.177,85	3.737,31
575,0	599,0	F2160575W1E	993,78	993,78	1.834,65				2.195,80	2.195,80	3.809,02
600,0	624,0	F2160600W1E	1.051,77	1.051,77	1.892,66				2.261,51	2.261,51	3.922,56
625,0	649,0	F2160625W1E	1.555,22	1.555,22	2.446,20				2.279,42	2.279,42	3.994,28
650,0	674,0	F2160650W1E	1.589,51	1.589,51	2.517,40				2.300,35	2.300,35	4.065,94
675,0	699,0	F2160675W1E	1.618,51	1.618,51	2.583,28				2.324,24	2.324,24	4.134,66
700,0	724,0	F2160700W1E	1.650,11	1.650,11	2.651,86				2.386,99	2.386,99	4.248,18
725,0	749,0	F2160725W1E	1.684,39	1.684,39	2.720,35				2.407,93	2.407,93	4.319,87
750,0	799,0	F2160750W1E	1.710,79	1.710,79	2.786,28				2.443,76	2.443,76	4.457,30
800,0	849,0	F2160800W1E	1.781,94	1.781,94	2.852,16				2.485,55	2.485,55	4.600,69
850,0	899,0	F2160850W1E	1.839,95	1.839,95	2.918,05						
900,0	949,0	F2160900W1E	1.905,83	1.905,83	3.057,74						
950,0	999,0	F2160950W1E	1.969,09	1.969,09	3.197,47						
1.000,0	1.049,0	F2161000W1E	2.027,08	2.027,08	3.331,92						
1.050,0	1.099,0	F2161050W1E	2.098,23	2.098,23	3.461,08						
1.100,0	1.149,0	F2161100W1E	2.158,90	2.158,90	3.577,04						
1.150,0	1.199,0	F2161150W1E	2.222,13	2.222,13	3.698,31						
1.200,0	1.249,0	F2161200W1E	2.285,41	2.285,41	3.822,21						
1.250,0	1.299,0	F2161250W1E	2.351,30	2.351,30	3.948,73						
1.300,0	1.349,0	F2161300W1E	2.417,21	2.417,21	4.072,63						
1.350,0	1.399,0	F2161350W1E	2.480,47	2.480,47	4.196,51						
1.400,0	1.449,0	F2161400W1E	2.546,37	2.546,37	4.325,69						
1.450,0	1.499,0	F2161450W1E	2.612,29	2.612,29	4.449,58						

Acoplamiento para tubos de cualquier material sin anclaje axial.

Acoplamiento de unión y compensador todo en uno.

Código W1 en NBR termina W1N
Código W1 en FKM termina W1F

Código W2 en EPDM termina W2E
Código W2 en NBR termina W2N
Código W2 en FKM termina W2F

Código W5 en EPDM termina W5E
Código W5 en NBR termina W5N
Código W5 en FKM termina W5F

(1) Los acoplamientos con la junta en FKM llevan incluido un anillo interior en acero inoxidable.

En caso de pedido indicar el diámetro exterior exacto.

Junta: EPDM: -20°C hasta +100°C NBR: -20°C hasta +80°C FKM: -20°C hasta +180°C

Fluido: EPDM: Todas las calidades de agua, aguas residuales, aire, sólidos y diversos productos químicos.

NBR: Agua, gas, aceite, combustible y otros hidrocarburos.

FKM: Ozono, oxígeno, ácidos, gas, aceite y carburantes.

Especificar 1 o 2 cierres

FLEX 2 PN 20  PN  Consultar

desde Ø exterior	hasta Ø exterior	Ref. EPDM	W1 CARCASA GALVANIZADA. CIERRES GALVANIZADOS			W2 CARCASA EN ACERO INOX. CIERRES GALVANIZADOS			W5 CARCASA EN ACERO INOX. CIERRES EN ACERO INOX.		
			€ EPDM	€ NBR	€ FKM (1)	€ EPDM	€ NBR	€ FKM (1)	€ EPDM	€ NBR	€ FKM (1)
180,0	199,0					624,71	624,71	785,53	714,33	714,33	875,16
200,0	224,0					643,18	643,18	838,25	732,79	732,79	927,87
225,0	249,0					658,97	658,97	901,50	748,62	748,62	991,13
250,0	274,0					680,12	680,12	964,78	769,75	769,75	1.054,41
275,0	299,0	F2200275W1E	801,35	801,35	1.133,48	695,90	695,90	1.025,40	785,53	785,53	1.115,03
300,0	324,0	F2200300W1E	814,53	814,53	1.191,46	714,32	714,32	1.091,30	803,95	803,95	1.180,93
325,0	349,0	F2200325W1E	827,69	827,69	1.254,72				2.010,55	2.010,55	3.115,94
350,0	374,0	F2200350W1E	840,89	840,89	1.307,46				2.025,50	2.025,50	3.184,64
375,0	399,0	F2200375W1E	854,09	854,09	1.370,71				2.049,41	2.049,41	3.259,33
400,0	424,0	F2200400W1E	872,51	872,51	1.433,96				2.064,33	2.064,33	3.325,06
425,0	449,0	F2200425W1E	885,69	885,69	1.484,08				2.082,26	2.082,26	3.393,77
450,0	474,0	F2200450W1E	898,89	898,89	1.539,42				2.106,17	2.106,17	3.465,46
475,0	499,0	F2200475W1E	1.325,90	1.325,90	2.003,34				2.124,10	2.124,10	3.531,17
500,0	524,0	F2200500W1E	1.341,70	1.341,70	2.064,02				2.142,02	2.142,02	3.602,89
525,0	549,0	F2200525W1E	1.370,71	1.370,71	2.132,50				2.159,95	2.159,95	3.671,61
550,0	574,0	F2200550W1E	1.410,26	1.410,26	2.211,59				2.177,85	2.177,85	3.737,31
575,0	599,0	F2200575W1E	1.439,25	1.439,25	2.280,16				2.195,80	2.195,80	3.809,02
600,0	624,0	F2200600W1E	1.523,59	1.523,59	2.364,51				2.261,51	2.261,51	3.922,56
625,0	649,0	F2200625W1E	1.555,22	1.555,22	2.446,20				2.279,42	2.279,42	3.994,28
650,0	674,0	F2200650W1E	1.589,51	1.589,51	2.517,40						
675,0	699,0	F2200675W1E	1.618,51	1.618,51	2.583,28						
700,0	724,0	F2200700W1E	1.650,11	1.650,11	2.651,86						
725,0	749,0	F2200725W1E	1.684,39	1.684,39	2.720,35						
750,0	799,0	F2200750W1E	1.710,79	1.710,79	2.786,28						
800,0	849,0	F2200800W1E	1.781,94	1.781,94	2.852,16						
850,0	899,0	F2200850W1E	1.839,95	1.839,95	2.918,05						
900,0	949,0	F2200900W1E	1.905,83	1.905,83	3.057,74						
950,0	999,0	F2200950W1E	1.969,09	1.969,09	3.197,47						

Acoplamiento para tubos de cualquier material sin anclaje axial.

Acoplamiento de unión y compensador todo en uno.

Código W1 en NBR termina W1N
Código W1 en FKM termina W1F

Código W2 en EPDM termina W2E
Código W2 en NBR termina W2N
Código W2 en FKM termina W2F

Código W5 en EPDM termina W5E
Código W5 en NBR termina W5N
Código W5 en FKM termina W5F

(1) Los acoplamientos con la junta en FKM llevan incluido un anillo interior en acero inoxidable.

En caso de pedido indicar el diámetro exterior exacto.

Junta: EPDM: -20°C hasta +100°C NBR: -20°C hasta +80°C FKM: -20°C hasta +180°C

Fluido: EPDM: Todas las calidades de agua, aguas residuales, aire, sólidos y diversos productos químicos.

NBR: Agua, gas, aceite, combustible y otros hidrocarburos.

FKM: Ozono, oxígeno, ácidos, gas, aceite y carburantes.

Especificar 1 o 2 cierres

FLEX 2 PN 25

 PN
 
 Consultar

desde Ø exterior	hasta Ø exterior	Ref. EPDM	W1 CARCASA GALVANIZADA. CIERRES GALVANIZADOS			W2 CARCASA EN ACERO INOX. CIERRES GALVANIZADOS			W5 CARCASA EN ACERO INOX. CIERRES EN ACERO INOX.		
			€ EPDM	€ NBR	€ FKM (1)	€ EPDM	€ NBR	€ FKM (1)	€ EPDM	€ NBR	€ FKM (1)
180,0	199,0					832,96	832,96	993,78	922,60	922,60	1.083,40
200,0	224,0					851,43	851,43	1.049,14	941,05	941,05	1.138,76
225,0	249,0					872,52	872,52	1.112,38	962,14	962,14	1.202,01
250,0	274,0					896,25	896,25	1.180,92	985,87	985,87	1.270,54
275,0	299,0	F2250275W1E	801,35	801,35	1.133,48				1.974,70	1.974,70	2.984,48
300,0	324,0	F2250300W1E	814,53	814,53	1.191,46				1.989,67	1.989,67	3.053,21
325,0	349,0	F2250325W1E	827,69	827,69	1.254,72				2.010,55	2.010,55	3.115,94
350,0	374,0	F2250350W1E	1.217,83	1.217,83	1.687,06				2.025,50	2.025,50	3.184,64
375,0	399,0	F2250375W1E	1.241,55	1.241,55	1.755,58				2.049,41	2.049,41	3.259,33
400,0	424,0	F2250400W1E	1.262,66	1.262,66	1.824,08				2.064,33	2.064,33	3.325,06
425,0	449,0	F2250425W1E	1.283,72	1.283,72	1.884,76				2.082,26	2.082,26	3.393,77
450,0	474,0	F2250450W1E	1.302,21	1.302,21	1.942,72				2.106,17	2.106,17	3.465,46
475,0	499,0	F2250475W1E	1.325,90	1.325,90	2.003,34				2.124,10	2.124,10	3.531,17
500,0	524,0	F2250500W1E	1.341,70	1.341,70	2.064,02				2.142,02	2.142,02	3.602,89
525,0	549,0	F2250525W1E	1.370,71	1.370,71	2.132,50						
550,0	574,0	F2250550W1E	1.410,26	1.410,26	2.211,59						
575,0	599,0	F2250575W1E	1.439,25	1.439,25	2.280,16						
600,0	624,0	F2250600W1E	1.523,59	1.523,59	2.364,51						
625,0	649,0	F2250625W1E	1.555,22	1.555,22	2.446,20						
650,0	674,0	F2250650W1E	1.589,51	1.589,51	2.517,40						
675,0	699,0	F2250675W1E	1.618,51	1.618,51	2.583,28						
700,0	724,0	F2250700W1E	1.650,11	1.650,11	2.651,86						
725,0	749,0	F2250725W1E	1.684,39	1.684,39	2.720,35						

Acoplamiento para tubos de cualquier material sin anclaje axial.

Acoplamiento de unión y compensador todo en uno.

Código W1 en NBR termina W1N
Código W1 en FKM termina W1F

Código W2 en EPDM termina W2E
Código W2 en NBR termina W2N
Código W2 en FKM termina W2F

Código W5 en EPDM termina W5E
Código W5 en NBR termina W5N
Código W5 en FKM termina W5F

(1) Los acoplamientos con la junta en FKM llevan incluido un anillo interior en acero inoxidable.

En caso de pedido indicar el diámetro exterior exacto.

Junta: EPDM: -20°C hasta +100°C NBR: -20°C hasta +80°C FKM: -20°C hasta +180°C

Fluido: EPDM: Todas las calidades de agua, aguas residuales, aire, sólidos y diversos productos químicos.

NBR: Agua, gas, aceite, combustible y otros hidrocarburos.

FKM: Ozono, oxígeno, ácidos, gas, aceite y carburantes.

Especificar 1 o 2 cierres

FLEX 3 PN 2,5

 Consultar

desde Ø exterior	hasta Ø exterior	W1 CARCASA GALVANIZADA. CIERRES GALVANIZADOS			W2 CARCASA EN ACERO INOX. CIERRES GALVANIZADOS		W5 CARCASA EN ACERO INOX. CIERRES EN ACERO INOX.	
		Ref. EPDM	€ EPDM	€ NBR	€ EPDM	€ NBR	€ EPDM	€ NBR
219,1	249,0					2.129,90	1.876,82	2.330,22
250,0	299,0					2.211,58	1.942,73	2.411,94
300,0	349,0	F3020300W1E	1.476,14	1.992,81	1.386,50	1.913,72	1.586,89	2.114,09
350,0	399,0	F3020350W1E	1.531,53	2.066,63	1.468,26	2.027,08	1.668,59	2.227,41
400,0	449,0	F3020400W1E	1.586,89	2.140,43	1.549,98	2.140,43	1.750,32	2.340,78
450,0	499,0	F3020450W1E	1.639,58	2.211,59	1.631,69	2.251,15	1.832,02	2.451,47
500,0	549,0	F3020500W1E	1.694,93	2.285,41	1.713,39	2.364,51	1.913,72	2.564,82
550,0	599,0	F3020550W1E	1.747,66	2.359,23	1.795,14	2.475,20	1.995,46	2.675,54
600,0	649,0	F3020600W1E	1.803,03	2.433,04	1.876,82	2.591,18	2.077,17	2.791,54
650,0	699,0	F3020650W1E	1.861,04	2.512,13	1.961,17	2.704,52	2.161,54	2.904,86
700,0	749,0	F3020700W1E	1.908,46	2.575,36	2.042,90	2.817,88	2.243,25	3.018,23
750,0	799,0	F3020750W1E	1.966,46	2.651,86	2.121,96	2.928,59	2.322,32	3.128,90
800,0	849,0	F3020800W1E	2.021,82	2.730,90	2.203,73	3.044,54	2.404,04	3.244,94
850,0	899,0	F3020850W1E	2.085,09	2.815,25	2.285,41	3.155,31	2.485,73	3.355,62
900,0	949,0	F3020900W1E	2.150,97	2.902,24	2.364,51	3.263,36	2.564,82	3.463,71
950,0	999,0	F3020950W1E	2.214,28	2.991,86	2.448,85	3.379,36	2.649,17	3.579,66
1.000,0	1.049,0	F3021000W1E	2.280,16	3.078,84	2.525,28	3.482,14	2.725,61	3.682,51
1.050,0	1.099,0	F3021050W1E	2.348,67	3.171,12	2.609,65	3.600,77	2.809,96	3.801,09
1.100,0	1.149,0	F3021100W1E	2.411,93	3.255,47	2.691,38	3.714,12	2.891,72	3.914,45
1.150,0	1.199,0	F3021150W1E	2.464,66	3.329,30	2.773,09	3.824,85	2.973,39	4.025,16
1.200,0	1.249,0	F3021200W1E	2.541,09	3.432,07	2.823,16	3.895,99	3.023,49	4.096,37
1.250,0	1.299,0	F3021250W1E	2.620,17	3.537,49	2.878,51	3.972,45	3.078,84	4.172,79
1.300,0	1.349,0	F3021300W1E	2.696,66	3.640,32	2.928,59	4.043,62	3.128,90	4.243,96
1.350,0	1.399,0	F3021350W1E	2.775,69	3.745,74	2.983,96	4.120,07	3.184,30	4.320,41
1.400,0	1.449,0	F3021400W1E	2.852,16	3.851,19	3.041,97	4.196,51	3.242,27	4.396,85
1.450,0	1.499,0	F3021450W1E	2.925,97	3.951,40	3.110,48	4.291,43	3.310,83	4.491,74
1.500,0	1.549,0	F3021500W1E	3.005,07	4.056,81	3.181,67	4.391,58	3.381,98	4.591,90
1.550,0	1.599,0	F3021550W1E	3.078,84	4.156,99	3.442,60	4.752,73	3.642,98	4.953,07
1.600,0	1.649,0	F3021600W1E	3.147,38	4.249,23	3.519,07	4.855,51	3.719,40	5.055,82
1.650,0	1.699,0	F3021650W1E	3.218,53	4.344,11	3.592,88	4.958,33	3.793,21	5.158,65
1.700,0	1.749,0	F3021700W1E	3.281,82	4.431,13	3.666,66	5.058,49	3.867,02	5.258,82
1.750,0	1.799,0	F3021750W1E	3.363,56	4.541,83	3.851,19	5.314,18	4.051,56	5.514,52
1.800,0	1.849,0	F3021800W1E	3.450,52	4.657,79	3.938,19	5.432,81	4.138,51	5.633,13
1.850,0	1.899,0	F3021850W1E	3.534,87	4.773,82	4.014,62	5.540,89	4.214,99	5.741,20
1.900,0	1.949,0	F3021900W1E	3.621,86	4.889,77	4.096,37	5.651,57	4.296,70	5.851,91
1.950,0	1.999,0	F3021950W1E	3.711,47	5.008,41	4.178,07	5.767,57	4.378,39	5.967,92
2.000,0	2.032,0	F3022000W1E	3.801,09	5.132,33	4.280,87	5.907,28	4.481,19	6.107,63

Acoplamiento para tubos de cualquier material sin anclaje axial.

Acoplamiento de unión y compensador todo en uno.

Código W1 en NBR termina W1N

Código W2 en EPDM termina W2E
Código W2 en NBR termina W2N

Código W5 en EPDM termina W5E
Código W5 en NBR termina W5N

En caso de pedido indicar el diámetro exterior exacto.

Junta: EPDM: -20°C hasta +100°C NBR: -20°C hasta +80°C
Fluido: EPDM: Todas las calidades de agua, aguas residuales, aire, sólidos y diversos productos químicos.
 NBR: Agua, gas, aceite, combustible y otros hidrocarburos.

Especificar 1 o 2 cierres



FLEX 3 PN 6

 Consultar

desde Ø exterior	hasta Ø exterior	W1 CARCASA GALVANIZADA. CIERRES GALVANIZADOS			W2 CARCASA EN ACERO INOX. CIERRES GALVANIZADOS		W5 CARCASA EN ACERO INOX. CIERRES EN ACERO INOX.	
		Ref. EPDM	€ EPDM	€ NBR	€ EPDM	€ NBR	€ EPDM	€ NBR
219,1	249,0					2.129,90	1.876,82	2.330,22
250,0	299,0					2.211,58	1.942,73	2.411,94
300,0	349,0	F3060300W1E	1.476,14	1.992,81	1.386,50	1.913,72	1.586,89	2.114,09
350,0	399,0	F3060350W1E	1.531,53	2.066,63	1.468,26	2.027,08	1.668,59	2.227,41
400,0	449,0	F3060400W1E	1.586,89	2.140,43	1.549,98	2.140,43	1.750,32	2.340,78
450,0	499,0	F3060450W1E	1.639,58	2.211,59	1.631,69	2.251,15	1.832,02	2.451,47
500,0	549,0	F3060500W1E	1.694,93	2.285,41	1.713,39	2.364,51	1.913,72	2.564,82
550,0	599,0	F3060550W1E	1.747,66	2.359,23	1.795,14	2.475,20	1.995,46	2.675,54
600,0	649,0	F3060600W1E	1.803,03	2.433,04	1.876,82	2.591,18	2.077,17	2.791,54
650,0	699,0	F3060650W1E	1.861,04	2.512,13	1.961,17	2.704,52	2.161,54	2.904,86
700,0	749,0	F3060700W1E	1.908,46	2.575,36	2.042,90	2.817,88	2.243,25	3.018,23
750,0	799,0	F3060750W1E	1.966,46	2.651,86	2.121,96	2.928,59	2.322,32	3.128,90
800,0	849,0	F3060800W1E	2.021,82	2.730,90	2.203,73	3.044,54	2.404,04	3.244,94
850,0	899,0	F3060850W1E	2.085,09	2.815,25	2.285,41	3.155,31	2.485,73	3.355,62
900,0	949,0	F3060900W1E	2.150,97	2.902,24	2.364,51	3.263,36	2.564,82	3.463,71
950,0	999,0	F3060950W1E	2.214,28	2.991,86	2.448,85	3.379,36	2.649,17	3.579,66
1.000,0	1.049,0	F3061000W1E	2.280,16	3.078,84			3.907,61	4.149,59
1.050,0	1.099,0	F3061050W1E	2.348,67	3.171,12			3.982,26	4.233,23
1.100,0	1.149,0	F3061100W1E	2.411,93	3.255,47			4.053,97	4.313,92
1.150,0	1.199,0	F3061150W1E	2.464,66	3.329,30			4.134,66	4.412,48
1.200,0	1.249,0	F3061200W1E	2.541,09	3.432,07			4.221,30	4.508,09
1.250,0	1.299,0	F3061250W1E	2.620,17	3.537,49			4.307,93	4.603,71
1.300,0	1.349,0	F3061300W1E	2.696,66	3.640,32			4.391,58	4.699,30
1.350,0	1.399,0	F3061350W1E	2.775,69	3.745,74			4.478,22	4.794,87
1.400,0	1.449,0	F3061400W1E	2.852,16	3.851,19			4.552,90	4.884,51
1.450,0	1.499,0	F3061450W1E	2.925,97	3.951,40			4.660,46	5.004,00
1.500,0	1.549,0	F3061500W1E	3.005,07	4.056,81			4.762,00	5.114,55
1.550,0	1.599,0	F3061550W1E	3.078,84	4.156,99			4.842,69	5.207,15
1.600,0	1.649,0	F3061600W1E	3.147,38	4.249,23			4.932,31	5.305,73
1.650,0	1.699,0	F3061650W1E	3.218,53	4.344,11			5.033,89	5.419,28
1.700,0	1.749,0	F3061700W1E	3.281,82	4.431,13			5.135,47	5.532,77
1.750,0	1.799,0	F3061750W1E	3.363,56	4.541,83			5.237,01	5.643,35
1.800,0	1.849,0	F3061800W1E	3.450,52	4.657,79			5.616,45	6.034,66
1.850,0	1.899,0	F3061850W1E	3.534,87	4.773,82			5.694,11	6.124,29
1.900,0	1.949,0	F3061900W1E	3.621,86	4.889,77			5.765,79	6.207,97
1.950,0	1.999,0	F3061950W1E	3.711,47	5.008,41			5.861,40	6.312,50
2.000,0	2.032,0	F3062000W1E	3.801,09	5.132,33			5.962,99	6.426,04

Acoplamiento para tubos de cualquier material sin anclaje axial.

Acoplamiento de unión y compensador todo en uno.

Código W1 en NBR termina W1N

Código W2 en EPDM termina W2E
Código W2 en NBR termina W2N

Código W5 en EPDM termina W5E
Código W5 en NBR termina W5N

En caso de pedido indicar el diámetro exterior exacto.

Junta: EPDM: -20°C hasta +100°C NBR: -20°C hasta +80°C

Fluido: EPDM: Todas las calidades de agua, aguas residuales, aire, sólidos y diversos productos químicos.

NBR: Agua, gas, aceite, combustible y otros hidrocarburos.

Especificar 1 o 2 cierres



FLEX 3 PN 10

 PN
  Consultar

desde Ø exterior	hasta Ø exterior	W1 CARCASA GALVANIZADA. CIERRES GALVANIZADOS			W2 CARCASA EN ACERO INOX. CIERRES GALVANIZADOS		W5 CARCASA EN ACERO INOX. CIERRES EN ACERO INOX.	
		Ref. EPDM	€ EPDM	€ NBR	€ EPDM	€ NBR	€ EPDM	€ NBR
219,1	249,0				1.676,51	2.129,90	1.876,82	2.330,22
250,0	299,0				1.742,40	2.211,58	1.942,73	2.411,94
300,0	349,0	F3100300W1E	1.476,14	1.992,81	1.386,50	1.913,72	1.586,89	2.114,09
350,0	399,0	F3100350W1E	1.531,53	2.066,63	1.468,26	2.027,08	1.668,59	2.227,41
400,0	449,0	F3100400W1E	1.586,89	2.140,43	1.549,98	2.140,43	1.750,32	2.340,78
450,0	499,0	F3100450W1E	1.639,58	2.211,59	1.631,69	2.251,15	1.832,02	2.451,47
500,0	549,0	F3100500W1E	1.694,93	2.285,41			2.876,92	3.002,39
525,0	549,0							
550,0	599,0	F3100550W1E	1.747,66	2.359,23			3.008,38	3.145,80
575,0	599,0							
600,0	649,0	F3100600W1E	1.803,03	2.433,04			3.160,76	3.313,13
650,0	699,0	F3100650W1E	1.861,04	2.512,13			3.232,44	3.396,75
700,0	749,0	F3100700W1E	1.908,46	2.575,36			3.304,14	3.480,38
750,0	799,0	F3100750W1E	1.966,46	2.651,86			3.381,80	3.570,02
800,0	849,0	F3100800W1E	2.021,82	2.730,90			3.465,46	3.662,64
850,0	899,0	F3100850W1E	2.085,09	2.815,25			3.632,76	3.841,90
900,0	949,0	F3100900W1E	2.150,97	2.902,24			3.737,31	3.958,42
950,0	999,0	F3100950W1E	2.214,28	2.991,86			3.823,96	4.053,97
1.000,0	1.049,0	F3101000W1E	2.280,16	3.078,84			3.907,61	4.149,59
1.050,0	1.099,0	F3101050W1E	2.348,67	3.171,12			3.982,26	4.233,23
1.100,0	1.149,0	F3101100W1E	2.411,93	3.255,47			4.053,97	4.313,92
1.150,0	1.199,0	F3101150W1E	2.464,66	3.329,30			4.134,66	4.412,48
1.200,0	1.249,0	F3101200W1E	2.541,09	3.432,07			4.221,30	4.508,09
1.250,0	1.299,0	F3101250W1E	5.912,22	6.620,24			4.307,93	4.603,71
1.300,0	1.349,0	F3101300W1E	6.016,76	6.739,73			4.391,58	4.699,30
1.350,0	1.399,0	F3101350W1E	6.130,29	6.865,19			4.478,22	4.794,87
1.400,0	1.449,0	F3101400W1E	6.243,82	6.990,68			4.552,90	4.884,51
1.450,0	1.499,0	F3101450W1E	6.354,34	7.116,15			Consultar	Consultar
1.500,0	1.549,0	F3101500W1E	6.467,90	7.244,61				
1.550,0	1.599,0	F3101550W1E	6.575,43	7.364,12				
1.600,0	1.649,0	F3101600W1E	6.688,93	7.489,60				
1.650,0	1.699,0	F3101650W1E	6.799,48	7.618,05				
1.700,0	1.749,0	F3101700W1E	6.912,97	7.746,50				
1.750,0	1.799,0	F3101750W1E	7.020,55	7.863,01				
1.800,0	1.849,0	F3101800W1E	7.134,07	7.991,49				
1.850,0	1.899,0	F3101850W1E	7.247,61	8.116,97				
1.900,0	1.949,0	F3101900W1E	7.361,10	8.242,45				
1.950,0	1.999,0	F3101950W1E	7.468,68	8.364,89				
2.000,0	2.032,0	F3102000W1E	7.573,23	8.481,42				

Acoplamiento para tubos de cualquier material sin anclaje axial.

Acoplamiento de unión y compensador todo en uno.

Código W1 en NBR termina W1N

Código W2 en EPDM termina W2E
Código W2 en NBR termina W2N

Código W5 en EPDM termina W5E
Código W5 en NBR termina W5N

En caso de pedido indicar el diámetro exterior exacto.

Junta: EPDM: -20°C hasta +100°C NBR: -20°C hasta +80°C

Fluido: EPDM: Todas las calidades de agua, aguas residuales, aire, sólidos y diversos productos químicos.

NBR: Agua, gas, aceite, combustible y otros hidrocarburos.

Especificar 1 o 2 cierres

FLEX 3 PN 16

 Consultar

desde Ø exterior	hasta Ø exterior	W1 CARCASA GALVANIZADA. CIERRES GALVANIZADOS			W2 CARCASA EN ACERO INOX. CIERRES GALVANIZADOS		W5 CARCASA EN ACERO INOX. CIERRES EN ACERO INOX.	
		Ref. EPDM	€ EPDM	€ NBR	€ EPDM	€ NBR	€ EPDM	€ NBR
219,1	249,0				1.676,51	2.129,90	1.876,82	2.330,22
250,0	299,0				1.742,40	2.211,58	1.942,73	2.411,94
300,0	349,0	F3160300W1E	1.476,14	1.992,81	1.386,50	1.913,72	1.586,89	2.114,09
350,0	399,0	F3160350W1E	1.531,53	2.066,63			2.515,46	2.605,09
375,0	399,0							
400,0	449,0	F3160400W1E	1.586,89	2.140,43			2.631,98	2.736,50
425,0	449,0							
450,0	499,0	F3160450W1E	1.639,58	2.211,59			2.751,45	2.868,00
475,0	499,0							
500,0	549,0	F3160500W1E	1.694,93	2.285,41			2.876,92	3.002,39
525,0	549,0							
550,0	599,0	F3160550W1E	1.747,66	2.359,23			3.008,38	3.145,80
575,0	599,0							
600,0	649,0	F3160600W1E	1.803,03	2.433,04			3.160,76	3.313,13
650,0	699,0	F3160650W1E	1.861,04	2.512,13			3.232,44	3.396,75
700,0	749,0	F3160700W1E	1.908,46	2.575,36			3.304,14	3.480,38
750,0	799,0	F3160750W1E	4.797,85	5.374,48			3.381,80	3.570,02
800,0	849,0	F3160800W1E	4.905,43	5.493,98			3.465,46	3.662,64
850,0	899,0	F3160850W1E	5.018,94	5.619,43			Consultar	Consultar
900,0	949,0	F3160900W1E	5.123,51	5.738,92				
950,0	999,0	F3160950W1E	5.237,01	5.864,38				
1.000,0	1.049,0	F3161000W1E	5.350,55	5.989,87				
1.050,0	1.099,0	F3161050W1E	5.464,10	6.121,31				
1.100,0	1.149,0	F3161100W1E	5.568,62	6.237,84				
1.150,0	1.199,0	F3161150W1E	5.682,17	6.366,29				
1.200,0	1.249,0	F3161200W1E	5.798,68	6.491,76				
1.250,0	1.299,0	F3161250W1E	5.912,22	6.620,24				
1.300,0	1.349,0	F3161300W1E	6.016,76	6.739,73				
1.350,0	1.399,0	F3161350W1E	6.130,29	6.865,19				
1.400,0	1.449,0	F3161400W1E	6.243,82	6.990,68				
1.450,0	1.499,0	F3161450W1E	6.354,34	7.116,15				
1.500,0	1.549,0	F3161500W1E	6.467,90	7.244,61				
1.550,0	1.599,0	F3161550W1E	Consultar	Consultar				

Acoplamiento para tubos de cualquier material sin anclaje axial.

Acoplamiento de unión y compensador todo en uno.

Código W1 en NBR termina W1N

Código W2 en EPDM termina W2E
Código W2 en NBR termina W2N

Código W5 en EPDM termina W5E
Código W5 en NBR termina W5N

En caso de pedido indicar el diámetro exterior exacto.

Junta: EPDM: -20°C hasta +100°C NBR: -20°C hasta +80°C

Fluido: EPDM: Todas las calidades de agua, aguas residuales, aire, sólidos y diversos productos químicos.

NBR: Agua, gas, aceite, combustible y otros hidrocarburos.

Especificar 1 o 2 cierres

FLEX 3 PN 20  PN  Consultar

W1 CARCASA GALVANIZADA. CIERRES GALVANIZADOS
W5 CARCASA EN ACERO INOX. CIERRES EN ACERO INOX.

desde Ø exterior	hasta Ø exterior	Ref. EPDM	€ EPDM	Ref. NBR	€ NBR	Ref. NBR	€ NBR	Ref. NBR	€ NBR
300,0	324,0		0,00		0,00	F3200300W5E	2.096,98	F3200300W5N	2.485,55
323,9	349,0	F3200323W1E	1.476,14	F3200323W1N	1.992,81				
325,0	349,0					F3200325W5E	2.455,71	F3200325W5N	2.545,33
350,0	399,0	F3200350W1E	1.531,53	F3200350W1N	2.066,63	F3200350W5E	2.515,48	F3200350W5N	2.605,09
375,0	399,0					F3200375W5E	2.572,21	F3200375W5N	2.670,81
400,0	449,0	F3200400W1E	1.586,89	F3200400W1N	2.140,43	F3200400W5E	2.631,98	F3200400W5N	2.736,50
425,0	449,0					F3200425W5E	2.688,71	F3200425W5N	2.799,24
450,0	499,0	F3200450W1E	1.639,58	F3200450W1N	2.211,60	F3200450W5E	2.751,41	F3200450W5N	2.868,00
475,0	499,0					F3200475W5E	2.814,21	F3200475W5N	2.936,68
500,0	549,0	F3200500W1E	1.694,93	F3200500W1N	2.285,41	F3200500W5E	2.876,91	F3200500W5N	3.002,39
525,0	549,0					F3200525W5E	2.942,61	F3200525W5N	3.074,10
550,0	599,0	F3200550W1E	4.382,63	F3200550W1N	4.908,43	F3200550W5E	3.008,38	F3200550W5N	3.145,80
575,0	599,0					F3200575W5E	3.077,08	F3200575W5N	3.217,51
600,0	649,0	F3200600W1E	4.466,25	F3200600W1N	5.001,02	F3200600W5E	3.160,78	F3200600W5N	3.313,13
650,0	699,0	F3200650W1E	4.579,77	F3200650W1N	5.129,47	F3200650W5E	Consulta	F3200650W5N	Consultar
700,0	749,0	F3200700W1E	4.687,35	F3200700W1N	5.245,97				
750,0	799,0	F3200750W1E	4.797,85	F3200750W1N	5.374,48				
800,0	849,0	F3200800W1E	4.905,43	F3200800W1N	5.493,94				
850,0	899,0	F3200850W1E	5.018,94	F3200850W1N	5.619,43				
900,0	949,0	F3200900W1E	5.123,51	F3200900W1N	5.738,92				
950,0	999,0	F3200950W1E	5.237,01	F3200950W1N	5.864,38				
1.000,0	1.049,0	F3201000W1E	5.350,55	F3201000W1N	5.989,87				
1.050,0	1.099,0	F3201050W1E	5.464,10	F3201050W1N	6.121,32				
1.100,0	1.149,0	F3201100W1E	5.568,62	F3201100W1N	6.237,84				
1.150,0	1.149,0	F3201150W1E	Consultar	F3201150W1N	Consultar				

Acoplamiento para tubos

de cualquier material sin anclaje axial.

Acoplamiento de unión y compensador todo en uno.

En caso de pedido indicar el diámetro exterior exacto.

Junta: EPDM: -20°C hasta +100°C NBR: -20°C hasta +80°C

Fluido: EPDM: Todas las calidades de agua, aguas residuales, aire, sólidos y diversos productos químicos.

NBR: Agua, gas, aceite, combustible y otros hidrocarburos.

Especificar 1 o 2 cierres

FLEX 3 PN 25   Consultar

W1 CARCASA GALVANIZADA. CIERRES GALVANIZADOS
W5 CARCASA EN ACERO INOX. CIERRES EN ACERO INOX.

desde Ø exterior	hasta Ø exterior	Ref. EPDM	€ EPDM	Ref. NBR	€ NBR	Ref. NBR	€ NBR	Ref. NBR	€ NBR
300,0	324,0					F3250300W5E	2.395,97	F3250300W5N	2.485,55
323,9	349,0	F3250323W1E	1.476,14	F3250323W1N	1.992,81	F3250323W5E	2.455,71	F3250323W5N	2.545,33
350,0	399,0	F3250350W1E	1.531,53	F3250350W1N	2.066,63	F3250350W5E	2.515,46	F3250350W5N	2.605,09
375,0	399,0					F3250375W5E	2.572,21	F3250375W5N	2.670,81
400,0	449,0	F3250400W1E	1.586,89	F3250400W1N	2.140,43	F3250400W5E	2.631,98	F3250400W5N	2.736,50
425,0	449,0					F3250425W5E	2.688,72	F3250425W5N	2.799,24
450,0	499,0	F3250450W1E	1.639,58	F3250450W1N	2.211,59	F3250450W5E	2.751,45	F3250450W5N	2.868,00
475,0	499,0					F3250475W5E	2.814,21	F3250475W5N	2.936,68
500,0	549,0					F3250500W5E	Consultar	F3250500W5N	Consultar
550,0	599,0	F3250550W1E	4.466,25	F3250550W1N	4.908,43				
600,0	649,0	F3250600W1E	4.579,77	F3250600W1N	5.001,02				
650,0	699,0	F3250650W1E	4.687,35	F3250650W1N	5.129,47				
700,0	749,0	F3250700W1E	4.797,85	F3250700W1N	5.245,97				
750,0	799,0	F3250750W1E	4.905,43	F3250750W1N	5.374,48				
800,0	849,0	F3250800W1E	5.018,94	F3250800W1N	5.493,98				
850,0	899,0	F3250850W1E	5.123,52	F3250850W1N	5.619,43				
900,0	949,0	F3250900W1E	5.123,51	F3250900W1N	5.738,92				
950,0	999,0	F3250950W1E	Consultar	F3250950W1N	Consultar				

Acoplamiento para tubos de cualquier material sin anclaje axial.
 Acoplamiento de unión y compensador todo en uno.

En caso de pedido indicar el diámetro exterior exacto.
Junta: EPDM: -20°C hasta +100°C NBR: -20°C hasta +80°C
Fluido: EPDM: Todas las calidades de agua, aguas residuales, aire, sólidos y diversos productos químicos.
 NBR: Agua, gas, aceite, combustible y otros hidrocarburos.
 Especificar 1 o 2 cierres



OPEN FLEX 1

CARCASA EN ACERO GALVANIZADO

diámetro exterior	PN (bar)	PN (bar)	Ref. EPDM	€ EPDM	Ref. NBR	€ NBR	Ref. FKM(1)	€ FKM
48,3	25,0	16,0	35001	129,97	35003	129,97	35009	212,06
54,0	25,0	16,0	35051	133,86	35053	133,86	35057	216,39
57,0	25,0	16,0	35101	136,04	35103	136,04	35106	220,91
60,3	25,0	16,0	35151	138,17	35153	138,17	35166	223,09
73,0	25,0	16,0	35201	150,30	35203	150,30	35213	251,23
76,1	25,0	16,0	35251	151,62	35253	151,62	35267	255,58
84,0	25,0	16,0	35301	155,08	35303	155,08	35309	262,06
88,9	25,0	16,0	35351	157,48	35353	157,48	35368	264,28
100,6	25,0	16,0	35401	161,82	35403	161,82	35411	270,73
101,6	25,0	16,0	35451	162,22	35453	162,22	35459	270,73
104,0	20,0	16,0	35501	162,65	35503	162,65	35514	272,93
104,8	20,0	16,0	35551	163,11	35553	163,11	35559	272,93
108,0	20,0	16,0	35601	164,84	35603	164,84	35614	275,07
114,3	20,0	16,0	35651	166,36	35653	166,36	35645	277,25
118,0	20,0	16,0	35671	167,43	35673	167,43	35636	294,56
127,0	20,0	16,0	35676	201,00	35678	201,00	35685	318,40
129,0	20,0	16,0	35701	202,07	35703	202,07	35709	320,55
130,2	20,0	16,0	35751	203,37	35753	203,37	35759	322,73
133,0	16,0	16,0	35801	205,99	35803	205,99	35814	324,87
139,7	16,0	16,0	35851	209,43	35853	209,43	35858	340,05
141,3	16,0	16,0	35901	209,88	35903	209,88	35912	342,22
154,0	16,0	16,0	35951	215,94	35953	215,94	35958	361,70
159,0	16,0	16,0	36001	218,73	36003	218,73	36016	370,40
168,3	16,0	16,0	36051	225,26	36053	225,26	36067	383,37



Acoplamiento abierto para tubos de cualquier material sin anclaje axial. Abierto con bisagra.

(1) acoplamiento con anillo interior en acero inoxidable incorporado.
Junta: EPDM: -20°C hasta +100°C NBR: -20°C hasta +80°C FKM: -20°C hasta +180°C
Fluido: EPDM: Todas las calidades de agua, aguas residuales, aire, sólidos y diversos productos químicos.
 NBR: Agua, gas, aceite, combustible y otros hidrocarburos.
 FKM: Ozono, oxígeno, ácidos, gas, aceite y carburantes.



OPEN FLEX 1

CARCARA EN ACERO INOXIDABLE

diámetro exterior	 PN (bar)	 PN (bar)	Ref. EPDM	€ EPDM	Ref. NBR	€ NBR	Ref. FKM ⁽¹⁾	€ FKM
48,3	25,0	16,0	35000	164,40	35002	164,40	35007	244,74
54,0	25,0	16,0	35050	168,29	35052	168,29	35056	251,23
57,0	25,0	16,0	35100	169,59	35102	169,59	35108	253,42
60,3	25,0	16,0	35150	171,96	35152	171,96	35168	255,58
73,0	25,0	16,0	35200	184,95	35202	184,95	35209	288,06
76,1	25,0	16,0	35250	186,28	35252	186,28	35268	290,24
84,0	25,0	16,0	35300	189,72	35302	189,72	35308	294,56
88,9	25,0	16,0	35350	192,11	35352	192,11	35369	298,89
100,6	25,0	16,0	35400	196,24	35402	196,24	35410	303,22
101,6	25,0	16,0	35450	196,66	35452	196,66	35458	305,40
104,0	20,0	16,0	35500	197,34	35502	197,34	35515	305,40
104,8	20,0	16,0	35550	197,74	35552	197,74	35558	307,56
108,0	20,0	16,0	35600	199,03	35602	199,03	35609	309,73
114,3	20,0	16,0	35650	201,00	35652	201,00	35644	327,06
118,0	20,0	16,0	35670	202,07	35672	202,07	35635	311,89
127,0	20,0	16,0	35675	244,74	35677	244,74	35684	363,88
129,0	20,0	16,0	35700	246,89	35702	246,89	35708	366,03
130,2	20,0	16,0	35750	246,89	35752	246,89	35758	368,20
133,0	16,0	16,0	35800	249,10	35802	249,10	35813	370,40
139,7	16,0	16,0	35850	253,42	35852	253,42	35854	383,37
141,3	16,0	16,0	35900	253,42	35902	253,42	35911	383,37
154,0	16,0	16,0	35950	262,06	35952	262,06	35954	405,04
159,0	16,0	16,0	36000	266,42	36002	266,42	36015	415,87
168,3	16,0	16,0	36050	270,73	36052	270,73	36066	428,85

(1) acoplamiento con anillo interior en acero inoxidable incorporado.

Junta: EPDM: -20°C hasta +100°C NBR: -20°C hasta +80°C FKM: -20°C hasta +180°C

Fluido: EPDM: Todas las calidades de agua, aguas residuales, aire, sólidos y diversos productos químicos.

NBR: Agua, gas, aceite, combustible y otros hidrocarburos.

FKM: Ozono, oxígeno, ácidos, gas, aceite y carburantes.



OPEN FLEX 2 PN 2,5

desde Ø exterior	hasta Ø exterior	Ref. EPDM	W1 CARCASA GALVANIZADA. CIERRES GALVANIZADOS			W2 CARCASA EN ACERO INOX. CIERRES GALVANIZADOS			W5 CARCASA EN ACERO INOX. CIERRES EN ACERO INOX.		
			€ EPDM	€ NBR	€ FKM (1)	€ EPDM	€ NBR	€ FKM (1)	€ EPDM	€ NBR	€ FKM (1)
172,0	199,0					611,56	611,56	819,80	695,91	695,91	904,15
200,0	224,0					632,65	632,65	875,16	717,00	717,00	959,51
225,0	249,0					645,82	645,82	930,51	730,17	730,17	1.014,87
250,0	274,0					664,26	664,26	988,53	748,62	748,62	1.072,82
275,0	299,0	OF2020275W1E	1.275,81	1.275,81	1.607,95	680,12	680,12	1.049,13	764,47	764,47	1.133,48
300,0	324,0	OF2020300W1E	1.296,89	1.296,89	1.676,52	701,20	701,20	1.104,50	785,53	785,53	1.188,83
325,0	349,0	OF2020325W1E	1.320,64	1.320,64	1.745,00	714,32	714,32	1.162,46	798,70	798,70	1.246,81
350,0	374,0	OF2020350W1E	1.341,70	1.341,70	1.808,30	735,44	735,44	1.225,75	819,83	819,83	1.310,08
375,0	399,0	OF2020375W1E	1.365,45	1.365,45	1.882,10	748,62	748,62	1.278,46	832,95	832,95	1.362,81
400,0	424,0	OF2020400W1E	1.386,50	1.386,50	1.950,66	761,80	761,80	1.336,43	846,15	846,15	1.420,78
425,0	449,0	OF2020425W1E	1.412,91	1.412,91	2.011,28	790,81	790,81	1.399,73	875,15	875,15	1.484,08
450,0	474,0	OF2020450W1E	1.433,96	1.433,96	2.074,55	806,64	806,64	1.455,07	890,98	890,98	1.539,42
475,0	499,0	OF2020475W1E	1.455,07	1.455,07	2.135,16	830,36	830,36	1.515,69	914,71	914,71	1.600,04
500,0	524,0	OF2020500W1E	1.476,14	1.476,14	2.198,43	851,45	851,45	1.573,69	935,79	935,79	1.658,05
525,0	549,0	OF2020525W1E	1.507,81	1.507,81	2.266,95	880,43	880,43	1.639,58	964,78	964,78	1.723,95
550,0	574,0	OF2020550W1E	1.549,98	1.549,98	2.353,96	896,27	896,27	1.697,58	980,61	980,61	1.781,94
575,0	599,0	OF2020575W1E	1.581,62	1.581,62	2.425,11	919,97	919,97	1.752,97	1.004,32	1.004,32	1.837,30
600,0	624,0	OF2020600W1E	1.676,52	1.676,52	2.517,40	1.064,97	1.064,97	1.911,09	1.149,31	1.149,31	1.995,46
625,0	649,0	OF2020625W1E	1.708,13	1.708,13	2.599,11	1.093,97	1.093,97	1.990,20	1.178,30	1.178,30	2.074,55
650,0	674,0	OF2020650W1E	1.745,00	1.745,00	2.675,54	1.120,30	1.120,30	2.053,44	1.204,66	1.204,66	2.137,79
675,0	699,0	OF2020675W1E	1.779,28	1.779,28	2.741,47	1.154,57	1.154,57	2.116,71	1.238,94	1.238,94	2.201,06
700,0	724,0	OF2020700W1E	1.816,23	1.816,23	2.817,88	1.175,64	1.175,64	2.174,70	1.260,01	1.260,01	2.259,07
725,0	749,0	OF2020725W1E	1.850,50	1.850,50	2.889,05	1.207,26	1.207,26	2.237,95	1.291,64	1.291,64	2.322,32
750,0	799,0	OF2020750W1E	1.879,46	1.879,46	2.931,24	1.433,96	1.433,96	2.382,98	1.518,33	1.518,33	2.467,31
800,0	849,0	OF2020800W1E	1.955,91	1.955,91	3.018,23	1.484,08	1.484,08	2.509,48	1.568,42	1.568,42	2.593,84

Acoplamiento abierto para tubos de cualquier material sin anclaje axial.

Abierto con bisagra.

Código W1 en NBR termina W1N
Código W1 en FKM termina W1F

Código W2 en EPDM termina W2E
Código W2 en NBR termina W2N
Código W2 en FKM termina W2F

Código W5 en EPDM termina W5E
Código W5 en NBR termina W5N
Código W5 en FKM termina W5F

Continúa en la página siguiente...

desde Ø exterior	hasta Ø exterior	Ref. EPDM	W1 CARCASA GALVANIZADA. CIERRES GALVANIZADOS			W2 CARCASA EN ACERO INOX. CIERRES GALVANIZADOS			W5 CARCASA EN ACERO INOX. CIERRES EN ACERO INOX.		
			€ EPDM	€ NBR	€ FKM (1)	€ EPDM	€ NBR	€ FKM (1)	€ EPDM	€ NBR	€ FKM (1)
850,0	899,0	OF2020850W1E	2.024,46	2.024,46	3.102,57	1.536,81	1.536,81	2.630,72	1.621,16	1.621,16	2.715,08
900,0	949,0	OF2020900W1E	2.092,96	2.092,96	3.244,94	1.592,16	1.592,16	2.754,61	1.676,52	1.676,52	2.838,96
950,0	999,0	OF2020950W1E	2.164,16	2.164,16	3.395,19	1.642,24	1.642,24	2.878,51	1.726,59	1.726,59	2.962,86
1.000,0	1.049,0	OF2021000W1E	2.232,69	2.232,69	3.534,87	1.700,21	1.700,21	3.002,39	1.784,57	1.784,57	3.086,75
1.050,0	1.099,0	OF2021050W1E	2.311,78	2.311,78	3.674,59	1.771,42	1.771,42	3.131,57	1.855,77	1.855,77	3.215,93
1.100,0	1.149,0	OF2021100W1E	2.372,38	2.372,38	3.790,55	1.847,83	1.847,83	3.266,00	1.932,20	1.932,20	3.350,37
1.150,0	1.199,0	OF2021150W1E	2.443,58	2.443,58	3.919,72	1.921,66	1.921,66	3.395,19	2.006,01	2.006,01	3.479,55
1.200,0	1.249,0	OF2021200W1E	2.514,76	2.514,76	4.051,56	1.995,46	1.995,46	3.524,35	2.079,81	2.079,81	3.608,70
1.250,0	1.299,0	OF2021250W1E	2.585,92	2.585,92	4.180,72	2.069,27	2.069,27	3.656,11	2.153,61	2.153,61	3.740,47
1.300,0	1.349,0	OF2021300W1E	2.654,45	2.654,45	4.312,49	2.143,07	2.143,07	3.787,95	2.227,41	2.227,41	3.872,30
1.350,0	1.399,0	OF2021350W1E	2.725,61	2.725,61	4.441,66	2.214,28	2.214,28	3.917,12	2.298,62	2.298,62	4.001,46
1.400,0	1.449,0	OF2021400W1E	2.796,81	2.796,81	4.576,11	2.288,07	2.288,07	4.048,89	2.372,38	2.372,38	4.133,26
1.450,0	1.499,0	OF2021450W1E	2.868,00	2.868,00	4.705,27	2.361,84	2.361,84	4.180,72	2.446,20	2.446,20	4.265,08
1.500,0	1.549,0	OF2021500W1E	2.936,50	2.936,50	4.834,45	3.049,87	3.049,87	4.947,78	3.139,48	3.139,48	5.037,41
1.550,0	1.600,0	OF2021550W1E	3.007,68	3.007,68	4.966,20	3.142,09	3.142,09	5.098,03	3.231,73	3.231,73	5.187,66
1.600,0	1.649,0	OF2021600W1E	3.078,84	3.078,84	5.095,38	3.234,40	3.234,40	5.250,93	3.324,00	3.324,00	5.340,54
1.650,0	1.699,0	OF2021650W1E	3.150,05	3.150,05	5.227,19	3.326,62	3.326,62	5.403,79	3.416,26	3.416,26	5.493,41
1.700,0	1.749,0	OF2021700W1E	3.221,19	3.221,19	5.356,37	3.418,91	3.418,91	5.554,04	3.508,55	3.508,55	5.643,67
1.750,0	1.799,0	OF2021750W1E	3.289,73	3.289,73	5.488,15	3.511,15	3.511,15	5.706,95	3.600,77	3.600,77	5.796,59
1.800,0	1.849,0	OF2021800W1E	3.360,91	3.360,91	5.617,32	3.603,42	3.603,42	5.859,83	3.693,05	3.693,05	5.949,46
1.850,0	1.899,0	OF2021850W1E	3.432,07	3.432,07	5.749,14	3.695,69	3.695,69	6.010,08	3.785,28	3.785,28	6.099,71
1.900,0	1.949,0	OF2021900W1E	3.503,26	3.503,26	5.878,29	3.787,95	3.787,95	6.162,99	3.877,58	3.877,58	6.252,59
1.950,0	1.999,0	OF2021950W1E	3.571,77	3.571,77	6.007,48	3.880,17	3.880,17	6.315,85	3.969,82	3.969,82	6.405,46
2.000,0	2.032,0	OF2022000W1E	3.642,98	3.642,98	6.139,26	3.972,45	3.972,45	6.466,11	4.062,09	4.062,09	6.555,73

Código W1 en NBR termina W1N
Código W1 en FKM termina W1F

Código W2 en EPDM termina W2E
Código W2 en NBR termina W2N
Código W2 en FKM termina W2F

Código W5 en EPDM termina W5E
Código W5 en NBR termina W5N
Código W5 en FKM termina W5F

(1) acoplamiento con anillo interior en acero inoxidable incorporado.

Junta: EPDM: -20°C hasta +100°C NBR: -20°C hasta +80°C FKM: -20°C hasta +180°C

Fluido: EPDM: Todas las calidades de agua, aguas residuales, aire, sólidos y diversos productos químicos.

NBR: Agua, gas, aceite, combustible y otros hidrocarburos.

FKM: Ozono, oxígeno, ácidos, gas, aceite y carburantes.

Especificar 1 o 2 cierres



OPEN FLEX 2 PN 6

desde Ø exterior	hasta Ø exterior	Ref. EPDM	W1 CARCASA GALVANIZADA. CIERRES GALVANIZADOS			W2 CARCASA EN ACERO INOX. CIERRES GALVANIZADOS			W5 CARCASA EN ACERO INOX. CIERRES EN ACERO INOX.		
			€ EPDM	€ NBR	€ FKM (1)	€ EPDM	€ NBR	€ FKM (1)	€ EPDM	€ NBR	€ FKM (1)
172,0	199,0					611,56	611,56	819,80	695,91	695,91	904,15
200,0	224,0					632,65	632,65	875,16	717,00	717,00	959,51
225,0	249,0					645,82	645,82	930,51	730,17	730,17	1.014,87
250,0	274,0					664,26	664,26	988,53	748,62	748,62	1.072,82
275,0	299,0	OF2060275W1E	1.275,81	1.275,81	1.607,95	680,12	680,12	1.049,13	764,47	764,47	1.133,48
300,0	324,0	OF2060300W1E	1.296,89	1.296,89	1.676,52	701,20	701,20	1.104,50	785,53	785,53	1.188,83
325,0	349,0	OF2060325W1E	1.320,64	1.320,64	1.745,00	714,32	714,32	1.162,46	798,70	798,70	1.246,81
350,0	374,0	OF2060350W1E	1.341,70	1.341,70	1.808,30	735,44	735,44	1.225,75	819,83	819,83	1.310,08
375,0	399,0	OF2060375W1E	1.365,45	1.365,45	1.882,10	748,62	748,62	1.278,46	832,95	832,95	1.362,81
400,0	424,0	OF2060400W1E	1.386,50	1.386,50	1.950,66	761,80	761,80	1.336,43	846,15	846,15	1.420,78
425,0	449,0	OF2060425W1E	1.412,91	1.412,91	2.011,28	790,81	790,81	1.399,73	875,15	875,15	1.484,08
450,0	474,0	OF2060450W1E	1.433,96	1.433,96	2.074,55	806,64	806,64	1.455,07	890,98	890,98	1.539,42
475,0	499,0	OF2060475W1E	1.455,07	1.455,07	2.135,16	830,36	830,36	1.515,69	914,71	914,71	1.600,04
500,0	524,0	OF2060500W1E	1.476,14	1.476,14	2.198,43	851,45	851,45	1.573,69	935,79	935,79	1.658,05
525,0	549,0	OF2060525W1E	1.507,81	1.507,81	2.266,95	946,32	946,32	1.718,67	1.030,67	1.030,67	1.803,03
550,0	574,0	OF2060550W1E	1.549,98	1.549,98	2.353,96	970,08	970,08	1.779,28	1.054,41	1.054,41	1.863,64
575,0	599,0	OF2060575W1E	1.581,62	1.581,62	2.425,11	993,78	993,78	1.837,30	1.078,15	1.078,15	1.921,66
600,0	624,0	OF2060600W1E	1.676,52	1.676,52	2.517,40	1.331,16	1.331,16	2.172,07	1.420,78	1.420,78	2.261,65
625,0	649,0	OF2060625W1E	1.708,13	1.708,13	2.599,11	1.368,10	1.368,10	2.259,07	1.457,71	1.457,71	2.348,67
650,0	674,0	OF2060650W1E	1.745,00	1.745,00	2.675,54	1.399,73	1.399,73	2.330,23	1.489,34	1.489,34	2.419,85
675,0	699,0	OF2060675W1E	1.779,28	1.779,28	2.741,47	1.441,91	1.441,91	2.406,67	1.531,53	1.531,53	2.496,27
700,0	724,0	OF2060700W1E	1.816,23	1.816,23	2.817,88	1.470,86	1.470,86	2.472,59	1.560,51	1.560,51	2.562,22
725,0	749,0	OF2060725W1E	1.850,50	1.850,50	2.889,05	1.513,07	1.513,07	2.549,00	1.602,70	1.602,70	2.638,65
750,0	799,0	OF2060750W1E	1.879,46	1.879,46	2.931,24	1.789,83	1.789,83	2.712,46	1.879,46	1.879,46	2.802,09
800,0	849,0	OF2060800W1E	1.955,91	1.955,91	3.018,23	1.853,09	1.853,09	2.857,43	1.942,72	1.942,72	2.947,05

Acoplamiento abierto para tubos de cualquier material sin anclaje axial.

Abierto con bisagra.

Código W1 en NBR termina W1N
Código W1 en FKM termina W1F

Código W2 en EPDM termina W2E
Código W2 en NBR termina W2N
Código W2 en FKM termina W2F

Código W5 en EPDM termina W5E
Código W5 en NBR termina W5N
Código W5 en FKM termina W5F

Continúa en la página siguiente...

desde Ø exterior	hasta Ø exterior	Ref. EPDM	W1 CARCASA GALVANIZADA. CIERRES GALVANIZADOS			W2 CARCASA EN ACERO INOX. CIERRES GALVANIZADOS			W5 CARCASA EN ACERO INOX. CIERRES EN ACERO INOX.		
			€ EPDM	€ NBR	€ FKM (1)	€ EPDM	€ NBR	€ FKM (1)	€ EPDM	€ NBR	€ FKM (1)
850,0	899,0	OF2060850W1E	2.024,46	2.024,46	3.102,57	1.918,99	1.918,99	2.997,15	2.008,62	2.008,62	3.086,75
900,0	949,0	OF2060900W1E	2.092,96	2.092,96	3.244,94	1.990,20	1.990,20	3.142,09	2.079,81	2.079,81	3.231,73
950,0	999,0	OF2060950W1E	2.164,16	2.164,16	3.395,19	2.056,08	2.056,08	3.284,47	2.145,70	2.145,70	3.374,10
1.000,0	1.049,0	OF2061000W1E	2.232,69	2.232,69	3.534,87	2.121,96	2.121,96	3.426,81	2.211,59	2.211,59	3.516,41
1.050,0	1.099,0	OF2061050W1E	2.311,78	2.311,78	3.674,59	2.211,59	2.211,59	3.577,04	2.301,22	2.301,22	3.666,66
1.100,0	1.149,0	OF2061100W1E	2.372,38	2.372,38	3.790,55	2.311,78	2.311,78	3.727,32	2.401,38	2.401,38	3.816,94
1.150,0	1.199,0	OF2061150W1E	2.443,58	2.443,58	3.919,72	2.404,04	2.404,04	3.880,17	2.493,67	2.493,67	3.969,82
1.200,0	1.249,0	OF2061200W1E	2.514,76	2.514,76	4.051,56				3.456,52	3.456,52	6.303,54
1.250,0	1.299,0	OF2061250W1E	2.585,92	2.585,92	4.180,72				3.540,15	3.540,15	6.488,80
1.300,0	1.349,0	OF2061300W1E	2.654,45	2.654,45	4.312,49				3.623,78	3.623,78	6.674,02
1.350,0	1.399,0	OF2061350W1E	2.725,61	2.725,61	4.441,66				3.710,42	3.710,42	6.862,22
1.400,0	1.449,0	OF2061400W1E	2.796,81	2.796,81	4.576,11				3.800,05	3.800,05	7.050,44
1.450,0	1.499,0	OF2061450W1E	2.868,00	2.868,00	4.705,27				3.892,66	3.892,66	7.241,64
1.500,0	1.549,0	OF2061500W1E	2.936,50	2.936,50	4.834,45				3.985,30	3.985,30	7.438,80
1.550,0	1.600,0	OF2061550W1E	3.007,68	3.007,68	4.966,20				4.080,87	4.080,87	7.629,98
1.600,0	1.649,0	OF2061600W1E	3.078,84	3.078,84	5.095,38				4.179,47	4.179,47	7.830,16
1.650,0	1.699,0	OF2061650W1E	3.150,05	3.150,05	5.227,19				4.281,06	4.281,06	8.033,30
1.700,0	1.749,0	OF2061700W1E	3.221,19	3.221,19	5.356,37				4.636,55	4.636,55	8.490,38
1.750,0	1.799,0	OF2061750W1E	3.289,73	3.289,73	5.488,15				4.753,05	4.753,05	8.705,48
1.800,0	1.849,0	OF2061800W1E	3.360,91	3.360,91	5.617,32				4.869,58	4.869,58	8.923,58
1.850,0	1.899,0	OF2061850W1E	3.432,07	3.432,07	5.749,14				4.995,03	4.995,03	9.144,61
1.900,0	1.949,0	OF2061900W1E	4.475,94	4.475,94	6.853,58				5.117,52	5.117,52	9.371,71
1.950,0	1.999,0	OF2061950W1E	4.565,58	4.565,58	7.001,22				5.245,97	5.245,97	9.601,69
2.000,0	2.032,0	OF2062000W1E	4.655,18	4.655,18	7.151,47				5.377,44	5.377,44	9.831,77

Código W1 en NBR termina W1N
Código W1 en FKM termina W1F

Código W2 en EPDM termina W2E
Código W2 en NBR termina W2N
Código W2 en FKM termina W2F

Código W5 en EPDM termina W5E
Código W5 en NBR termina W5N
Código W5 en FKM termina W5F

(1) acoplamiento con anillo interior en acero inoxidable incorporado.

Junta: EPDM: -20°C hasta +100°C NBR: -20°C hasta +80°C FKM: -20°C hasta +180°C

Fluido: EPDM: Todas las calidades de agua, aguas residuales, aire, sólidos y diversos productos químicos.

NBR: Agua, gas, aceite, combustible y otros hidrocarburos.

FKM: Ozono, oxígeno, ácidos, gas, aceite y carburantes.

Especificar 1 o 2 cierres



OPEN FLEX 2 PN 10

desde Ø exterior	hasta Ø exterior	Ref. EPDM	W1 CARCASA GALVANIZADA. CIERRES GALVANIZADOS			W2 CARCASA EN ACERO INOX. CIERRES GALVANIZADOS			W5 CARCASA EN ACERO INOX. CIERRES EN ACERO INOX.		
			€ EPDM	€ NBR	€ FKM (1)	€ EPDM	€ NBR	€ FKM (1)	€ EPDM	€ NBR	€ FKM (1)
172,0	199,0					611,56	611,56	819,80	695,91	695,91	904,15
200,0	224,0					632,65	632,65	875,16	717,00	717,00	959,51
225,0	249,0					645,82	645,82	930,51	730,17	730,17	1.014,87
250,0	274,0					664,26	664,26	988,53	748,62	748,62	1.072,82
275,0	299,0	OF2100275W1E	1.275,81	1.275,81	1.607,95	732,80	732,80	1.112,36	817,15	817,15	1.196,75
300,0	324,0	OF2100300W1E	1.296,89	1.296,89	1.676,52	756,53	756,53	1.178,30	840,89	840,89	1.262,66
325,0	349,0	OF2100325W1E	1.320,64	1.320,64	1.745,00	772,35	772,35	1.233,66	856,69	856,69	1.318,01
350,0	374,0	OF2100350W1E	1.341,70	1.341,70	1.808,30	993,78	993,78	1.460,34	1.083,40	1.083,40	1.549,98
375,0	399,0	OF2100375W1E	1.365,45	1.365,45	1.882,10	1.012,23	1.012,23	1.528,89	1.101,83	1.101,83	1.618,51
400,0	424,0	OF2100400W1E	1.386,50	1.386,50	1.950,66	1.030,67	1.030,67	1.594,75	1.120,30	1.120,30	1.684,39
425,0	449,0	OF2100425W1E	1.412,91	1.412,91	2.011,28	1.064,97	1.064,97	1.663,32	1.154,57	1.154,57	1.752,97
450,0	474,0	OF2100450W1E	1.433,96	1.433,96	2.074,55	1.088,70	1.088,70	1.729,21	1.178,30	1.178,30	1.818,83
475,0	499,0	OF2100475W1E	1.455,07	1.455,07	2.135,16	1.122,96	1.122,96	1.803,03	1.212,56	1.212,56	1.892,66
500,0	524,0	OF2100500W1E	1.476,14	1.476,14	2.198,43	1.151,94	1.151,94	1.874,19	1.241,55	1.241,55	1.963,81
525,0	549,0	OF2100525W1E	1.507,81	1.507,81	2.266,95	1.186,19	1.186,19	1.947,98	1.275,81	1.275,81	2.037,63
550,0	574,0	OF2100550W1E	1.549,98	1.549,98	2.353,96	1.215,20	1.215,20	2.019,19	1.304,81	1.304,81	2.108,82
575,0	599,0	OF2100575W1E	1.581,62	1.581,62	2.425,11	1.244,20	1.244,20	2.085,09	1.333,85	1.333,85	2.174,70
600,0	624,0	OF2100600W1E	1.676,52	1.676,52	2.517,40	1.331,16	1.331,16	2.172,07	1.420,78	1.420,78	2.261,65
625,0	649,0	OF2100625W1E	1.708,13	1.708,13	2.599,11	1.368,10	1.368,10	2.259,07	1.457,71	1.457,71	2.348,67
650,0	674,0	OF2100650W1E	1.745,00	1.745,00	2.675,54	1.399,73	1.399,73	2.330,23	1.489,34	1.489,34	2.419,85
675,0	699,0	OF2100675W1E	1.779,28	1.779,28	2.741,47	1.441,91	1.441,91	2.406,67	1.531,53	1.531,53	2.496,27
700,0	724,0	OF2100700W1E	1.816,23	1.816,23	2.817,88	1.470,86	1.470,86	2.472,59	1.560,51	1.560,51	2.562,22
725,0	749,0	OF2100725W1E	1.850,50	1.850,50	2.889,05				2.891,89	2.891,89	4.738,13
750,0	799,0	OF2100750W1E	1.879,46	1.879,46	2.931,24				2.939,65	2.939,65	4.884,51
800,0	849,0	OF2100800W1E	1.955,91	1.955,91	3.018,23				2.984,48	2.984,48	5.030,88

Acoplamiento abierto para tubos de cualquier material sin anclaje axial.

Abierto con bisagra.

Código W1 en NBR termina W1N
Código W1 en FKM termina W1F

Código W2 en EPDM termina W2E
Código W2 en NBR termina W2N
Código W2 en FKM termina W2F

Código W5 en EPDM termina W5E
Código W5 en NBR termina W5N
Código W5 en FKM termina W5F

Continúa en la página siguiente...

desde Ø exterior	hasta Ø exterior	Ref. EPDM	W1 CARCASA GALVANIZADA. CIERRES GALVANIZADOS			W2 CARCASA EN ACERO INOX. CIERRES GALVANIZADOS			W5 CARCASA EN ACERO INOX. CIERRES EN ACERO INOX.				
			€ EPDM	€ NBR	€ FKM (1)	€ EPDM	€ NBR	€ FKM (1)	€ EPDM	€ NBR	€ FKM (1)		
850,0	899,0	OF2100850W1E	2.024,46	2.024,46	3.102,57						3.020,33	3.020,33	5.168,35
900,0	949,0	OF2100900W1E	2.092,96	2.092,96	3.244,94						3.083,08	3.083,08	5.329,65
950,0	999,0	OF2100950W1E	2.164,16	2.164,16	3.395,19						3.124,92	3.124,92	5.473,06
1.000,0	1.049,0	OF2101000W1E	2.862,70	2.862,70	4.164,87						3.166,71	3.166,71	5.616,45
1.050,0	1.099,0	OF2101050W1E	2.962,86	2.962,86	4.325,69						3.208,53	3.208,53	5.756,85
1.100,0	1.149,0	OF2101100W1E	3.044,54	3.044,54	4.460,12						3.295,19	3.295,19	5.945,05
1.150,0	1.199,0	OF2101150W1E	3.134,19	3.134,19	4.610,38						3.381,80	3.381,80	6.133,26
1.200,0	1.249,0	OF2101200W1E	3.223,81	3.223,81	4.760,62								
1.250,0	1.299,0	OF2101250W1E	3.313,42	3.313,42	4.908,25								
1.300,0	1.349,0	OF2101300W1E	3.403,05	3.403,05	5.058,49								
1.350,0	1.399,0	OF2101350W1E	3.492,69	3.492,69	5.208,74								
1.400,0	1.449,0	OF2101400W1E	3.582,30	3.582,30	5.359,00								
1.450,0	1.499,0	OF2101450W1E	3.671,94	3.671,94	5.509,25								
1.500,0	1.549,0	OF2101500W1E	3.761,57	3.761,57	5.659,52								
1.550,0	1.600,0	OF2101550W1E	3.851,19	3.851,19	5.807,09								
1.600,0	1.649,0	OF2101600W1E	3.940,82	3.940,82	5.957,34								
1.650,0	1.699,0	OF2101650W1E	4.030,42	4.030,42	6.104,99								
1.700,0	1.749,0	OF2101700W1E	4.120,07	4.120,07	6.255,21								
1.750,0	1.799,0	OF2101750W1E	4.209,70	4.209,70	6.405,46								
1.800,0	1.849,0	OF2101800W1E	4.296,70	4.296,70	6.553,09								
1.850,0	1.899,0	OF2101850W1E	4.386,30	4.386,30	6.703,34								
1.900,0	1.949,0	OF2101900W1E	4.475,94	4.475,94	6.853,58								
1.950,0	1.999,0	OF2101950W1E	4.565,58	4.565,58	7.001,22								
2.000,0	2.032,0	OF2102000W1E	4.655,18	4.655,18	7.151,47								

Código W1 en NBR termina W1N
Código W1 en FKM termina W1F

Código W5 en EPDM termina W5E
Código W5 en NBR termina W5N
Código W5 en FKM termina W5F

(1) acoplamiento con anillo interior en acero inoxidable incorporado.

Junta: EPDM: -20°C hasta +100°C NBR: -20°C hasta +80°C FKM: -20°C hasta +180°C

Fluido: EPDM: Todas las calidades de agua, aguas residuales, aire, sólidos y diversos productos químicos.

NBR: Agua, gas, aceite, combustible y otros hidrocarburos.

FKM: Ozono, oxígeno, ácidos, gas, aceite y carburantes.

Especificar 1 o 2 cierres

OPEN FLEX 2 PN 16

desde Ø exterior	hasta Ø exterior	Ref. EPDM	W1 CARCASA GALVANIZADA. CIERRES GALVANIZADOS			W2 CARCASA EN ACERO INOX. CIERRES GALVANIZADOS			W5 CARCASA EN ACERO INOX. CIERRES EN ACERO INOX.		
			€ EPDM	€ NBR	€ FKM (1)	€ EPDM	€ NBR	€ FKM (1)	€ EPDM	€ NBR	€ FKM (1)
180,0	199,0					658,97	658,97	883,05	743,35	743,35	967,40
200,0	224,0					682,71	682,71	935,78	767,07	767,07	1.020,13
225,0	249,0					872,52	872,52	1.112,38	962,14	962,14	1.202,01
250,0	274,0					896,25	896,25	1.180,92	985,87	985,87	1.270,54
275,0	299,0	OF2160275W1E	1.275,81	1.275,81	1.607,95	914,71	914,71	1.246,81	1.004,32	1.004,32	1.336,43
300,0	324,0	OF2160300W1E	1.296,89	1.296,89	1.676,52	943,72	943,72	1.323,28	1.033,35	1.033,35	1.412,91
325,0	349,0	OF2160325W1E	1.320,64	1.320,64	1.745,00	964,78	964,78	1.389,17	1.054,41	1.054,41	1.478,79
350,0	374,0	OF2160350W1E	1.341,70	1.341,70	1.808,30	993,78	993,78	1.460,34	1.083,40	1.083,40	1.549,98
375,0	399,0	OF2160375W1E	1.365,45	1.365,45	1.882,10	1.012,23	1.012,23	1.528,89	1.101,83	1.101,83	1.618,51
400,0	424,0	OF2160400W1E	1.386,50	1.386,50	1.950,66	1.030,67	1.030,67	1.594,75	1.120,30	1.120,30	1.684,39
425,0	449,0	OF2160425W1E	1.412,91	1.412,91	2.011,28				2.640,93	2.640,93	3.886,71
450,0	474,0	OF2160450W1E	1.433,96	1.433,96	2.074,55				2.661,84	2.661,84	3.955,42
475,0	499,0	OF2160475W1E	1.455,07	1.455,07	2.135,16				2.676,79	2.676,79	4.021,14
500,0	524,0	OF2160500W1E	1.476,14	1.476,14	2.198,43				2.697,67	2.697,67	4.092,84
525,0	549,0	OF2160525W1E	1.507,81	1.507,81	2.266,95				2.715,62	2.715,62	4.161,54
550,0	574,0	OF2160550W1E	1.549,98	1.549,98	2.353,96				2.736,50	2.736,50	4.230,25
575,0	599,0	OF2160575W1E	1.581,62	1.581,62	2.425,11				2.754,43	2.754,43	4.298,98
600,0	624,0	OF2160600W1E	1.676,52	1.676,52	2.517,40				2.787,30	2.787,30	4.382,63
625,0	649,0	OF2160625W1E	2.190,53	2.190,53	3.081,49				2.805,23	2.805,23	4.451,35
650,0	674,0	OF2160650W1E	2.240,60	2.240,60	3.168,48				2.826,14	2.826,14	4.520,02
675,0	699,0	OF2160675W1E	2.280,16	2.280,16	3.244,94				2.844,05	2.844,05	4.591,72
700,0	724,0	OF2160700W1E	2.327,57	2.327,57	3.329,30				2.862,00	2.862,00	4.657,47
725,0	749,0	OF2160725W1E	2.372,38	2.372,38	3.410,97				2.891,89	2.891,89	4.738,13
750,0	799,0	OF2160750W1E	2.409,31	2.409,31	3.463,71				2.939,65	2.939,65	4.884,51
800,0	849,0	OF2160800W1E	2.509,48	2.509,48	3.569,16				2.984,48	2.984,48	5.030,88
850,0	899,0	OF2160850W1E	2.599,11	2.599,11	3.677,24						
900,0	949,0	OF2160900W1E	2.686,07	2.686,07	3.835,37						
950,0	999,0	OF2160950W1E	2.775,69	2.775,69	4.004,06						
1.000,0	1.049,0	OF2161000W1E	2.862,70	2.862,70	4.164,87						
1.050,0	1.099,0	OF2161050W1E	2.962,86	2.962,86	4.325,69						
1.100,0	1.149,0	OF2161100W1E	3.044,54	3.044,54	4.460,12						
1.150,0	1.199,0	OF2161150W1E	3.134,19	3.134,19	4.610,38						
1.200,0	1.249,0	OF2161200W1E	3.223,81	3.223,81	4.760,62						
1.250,0	1.299,0	OF2161250W1E	3.313,42	3.313,42	4.908,25						
1.300,0	1.349,0	OF2161300W1E	3.403,05	3.403,05	5.058,49						
1.350,0	1.399,0	OF2161350W1E	3.492,69	3.492,69	5.208,74						
1.400,0	1.449,0	OF2161400W1E	3.582,30	3.582,30	5.359,00						
1.450,0	1.499,0	OF2161450W1E	3.671,94	3.671,94	5.509,25						

Acoplamiento abierto para tubos de cualquier material sin anclaje axial.

Abierto con bisagra.

Código W1 en NBR termina W1N
Código W1 en FKM termina W1F

Código W2 en EPDM termina W2E
Código W2 en NBR termina W2N
Código W2 en FKM termina W2F

Código W5 en EPDM termina W5E
Código W5 en NBR termina W5N
Código W5 en FKM termina W5F

(1) acoplamiento con anillo interior en acero inoxidable incorporado.

Junta: EPDM: -20°C hasta +100°C NBR: -20°C hasta +80°C FKM: -20°C hasta +180°C

Fluido: EPDM: Todas las calidades de agua, aguas residuales, aire, sólidos y diversos productos químicos.

NBR: Agua, gas, aceite, combustible y otros hidrocarburos.

FKM: Ozono, oxígeno, ácidos, gas, aceite y carburantes.

Especificar 1 o 2 cierres



OPEN FLEX 2 PN 20

desde Ø exterior	hasta Ø exterior	Ref. EPDM	W1 CARCASA GALVANIZADA. CIERRES GALVANIZADOS			W2 CARCASA EN ACERO INOX. CIERRES GALVANIZADOS			W5 CARCASA EN ACERO INOX. CIERRES EN ACERO INOX.		
			€ EPDM	€ NBR	€ FKM (1)	€ EPDM	€ NBR	€ FKM (1)	€ EPDM	€ NBR	€ FKM (1)
180,0	199,0					832,96	832,96	993,78	922,60	922,60	1.083,40
200,0	224,0					851,43	851,43	1.049,14	941,05	941,05	1.138,76
225,0	249,0					872,52	872,51	1.112,38	962,14	962,14	1.202,01
250,0	274,0					896,25	896,25	1.180,92	985,87	985,87	1.270,54
275,0	299,0	OF2200275W1E	1.275,81	1.275,81	1.607,95	914,71	914,71	1.246,81	1.004,32	1.004,32	1.336,43
300,0	324,0	OF2200300W1E	1.296,89	1.296,89	1.676,52	943,72	943,72	1.323,28	1.033,35	1.033,35	1.412,91
325,0	349,0	OF2200325W1E	1.320,64	1.320,64	1.745,00				2.560,26	2.560,26	3.602,89
350,0	374,0	OF2200350W1E	1.341,70	1.341,70	1.808,30				2.575,18	2.575,18	3.671,61
375,0	399,0	OF2200375W1E	1.365,45	1.365,45	1.882,10				2.602,09	2.602,09	3.749,26
400,0	424,0	OF2200400W1E	1.386,50	1.386,50	1.950,66				2.623,02	2.623,02	3.815,02
425,0	449,0	OF2200425W1E	1.412,91	1.412,91	2.011,28				2.640,93	2.640,93	3.886,71
450,0	474,0	OF2200450W1E	1.433,96	1.433,96	2.074,55				2.661,84	2.661,84	3.955,42
475,0	499,0	OF2200475W1E	1.866,29	1.866,29	2.543,74				2.676,79	2.676,79	4.021,14
500,0	524,0	OF2200500W1E	1.892,66	1.892,66	2.614,89				2.697,67	2.697,67	4.092,84
525,0	549,0	OF2200525W1E	1.929,55	1.929,55	2.691,38				2.715,62	2.715,62	4.161,54
550,0	574,0	OF2200550W1E	1.987,55	1.987,55	2.791,54				2.736,50	2.736,50	4.230,25
575,0	599,0	OF2200575W1E	2.027,08	2.027,08	2.870,63				2.754,43	2.754,43	4.298,98
600,0	624,0	OF2200600W1E	2.148,34	2.148,34	2.989,22				2.787,30	2.787,30	4.382,63
625,0	649,0	OF2200625W1E	2.190,53	2.190,53	3.081,49				2.805,23	2.805,23	4.451,35
650,0	674,0	OF2200650W1E	2.240,60	2.240,60	3.168,48						
675,0	699,0	OF2200675W1E	2.280,16	2.280,16	3.244,94						
700,0	724,0	OF2200700W1E	2.327,57	2.327,57	3.329,30						
725,0	749,0	OF2200725W1E	2.372,38	2.372,38	3.410,97						
750,0	799,0	OF2200750W1E	2.409,31	2.409,31	3.463,71						
800,0	849,0	OF2200800W1E	2.509,48	2.509,48	3.569,16						
850,0	899,0	OF2200850W1E	2.599,11	2.599,11	3.677,24						
900,0	949,0	OF2200900W1E	2.686,07	2.686,07	3.835,37						
950,0	999,0	OF2200950W1E	2.775,69	2.775,69	4.004,06						

Acoplamiento abierto para tubos de cualquier material sin anclaje axial.

Abierto con bisagra.

Código W1 en NBR termina W1N
Código W1 en FKM termina W1F

Código W2 en EPDM termina W2E
Código W2 en NBR termina W2N
Código W2 en FKM termina W2F

Código W5 en EPDM termina W5E
Código W5 en NBR termina W5N
Código W5 en FKM termina W5F

(1) acoplamiento con anillo interior en acero inoxidable incorporado.

Junta: EPDM: -20°C hasta +100°C NBR: -20°C hasta +80°C FKM: -20°C hasta +180°C

Fluido: EPDM: Todas las calidades de agua, aguas residuales, aire, sólidos y diversos productos químicos.

NBR: Agua, gas, aceite, combustible y otros hidrocarburos.

FKM: Ozono, oxígeno, ácidos, gas, aceite y carburantes.

Especificar 1 o 2 cierres

OPEN FLEX 2 PN 25

desde Ø exterior	hasta Ø exterior	Ref. EPDM	W1 CARCASA GALVANIZADA. CIERRES GALVANIZADOS			W2 CARCASA EN ACERO INOX. CIERRES GALVANIZADOS			W5 CARCASA EN ACERO INOX. CIERRES EN ACERO INOX.		
			€ EPDM	€ NBR	€ FKM (1)	€ EPDM	€ NBR	€ FKM (1)	€ EPDM	€ NBR	€ FKM (1)
180,0	199,0					832,96	832,96	993,78	922,60	922,60	1.083,40
200,0	224,0					851,43	851,43	1.049,14	941,05	941,05	1.138,76
225,0	249,0					872,52	872,51	1.112,38	962,14	962,14	1.202,01
250,0	274,0					896,25	896,25	1.180,92	985,87	985,87	1.270,54
275,0	299,0	OF2250275W1E	1.181,31	1.275,81	1.607,95				2.521,41	2.521,41	3.465,47
300,0	324,0	OF2250300W1E	1.296,89	1.296,89	1.676,52				2.539,34	2.539,34	3.531,17
325,0	349,0	OF2250325W1E	1.320,64	1.320,64	1.745,00				2.560,26	2.560,26	3.602,89
350,0	374,0	OF2250350W1E	1.718,67	1.718,67	2.185,23				2.575,18	2.575,18	3.671,61
375,0	399,0	OF2250375W1E	1.750,32	1.750,32	2.266,95				2.602,09	2.602,09	3.749,26
400,0	424,0	OF2250400W1E	1.779,28	1.779,28	2.340,78				2.623,02	2.623,02	3.815,02
425,0	449,0	OF2250425W1E	1.810,95	1.810,95	2.411,93				2.640,93	2.640,93	3.886,71
450,0	474,0	OF2250450W1E	1.837,30	1.837,30	2.477,87				2.661,84	2.661,84	3.955,42
475,0	499,0	OF2250475W1E	1.866,29	1.866,29	2.543,74				2.676,79	2.676,79	4.021,14
500,0	524,0	OF2250500W1E	1.892,66	1.892,66	2.614,89				2.697,67	2.697,67	4.092,84
525,0	549,0	OF2250525W1E	1.929,55	1.929,55	2.691,38						
550,0	574,0	OF2250550W1E	1.987,55	1.987,55	2.791,54						
575,0	599,0	OF2250575W1E	2.027,08	2.027,08	2.870,63						
600,0	624,0	OF2250600W1E	2.148,34	2.148,34	2.989,22						
625,0	649,0	OF2250625W1E	2.190,53	2.190,53	3.081,49						
650,0	674,0	OF2250650W1E	2.240,60	2.240,60	3.168,48						
675,0	699,0	OF2250675W1E	2.280,16	2.280,16	3.244,94						
700,0	724,0	OF2250700W1E	2.327,57	2.327,57	3.329,30						
725,0	749,0	OF2250725W1E	2.372,38	2.372,38	3.410,97						

Acoplamiento abierto para tubos de cualquier material sin anclaje axial.

Abierto con bisagra.

Código W1 en NBR termina W1N
Código W1 en FKM termina W1F

Código W2 en EPDM termina W2E
Código W2 en NBR termina W2N
Código W2 en FKM termina W2F

Código W5 en EPDM termina W5E
Código W5 en NBR termina W5N
Código W5 en FKM termina W5F

(1) acoplamiento con anillo interior en acero inoxidable incorporado.

Junta: EPDM: -20°C hasta +100°C NBR: -20°C hasta +80°C FKM: -20°C hasta +180°C

Fluido: EPDM: Todas las calidades de agua, aguas residuales, aire, sólidos y diversos productos químicos.

NBR: Agua, gas, aceite, combustible y otros hidrocarburos.

FKM: Ozono, oxígeno, ácidos, gas, aceite y carburantes.

Especificar 1 o 2 cierres



OPEN FLEX 3 PN 2,5

desde Ø exterior	hasta Ø exterior	Ref. EPDM	W1 CARCASA GALVANIZADA. CIERRES GALVANIZADOS		W2 CARCASA EN ACERO INOX. CIERRES GALVANIZADOS		W5 CARCASA EN ACERO INOX. CIERRES EN ACERO INOX.	
			€ EPDM	€ NBR	€ EPDM	€ NBR	€ EPDM	€ NBR
219,1	249,0		0,00	0,00	1.676,51	2.129,90	1.876,82	2.330,22
250,0	299,0		0,00	0,00	1.742,40	2.211,58	1.942,73	2.411,94
300,0	349,0	OF3020300W1E	2.069,27	2.667,63	1.853,09	2.353,96	2.053,44	2.554,29
350,0	399,0	OF3020350W1E	2.145,70	2.767,81	1.966,46	2.496,27	2.166,79	2.696,66
400,0	449,0	OF3020400W1E	2.222,13	2.865,32	2.077,17	2.638,65	2.277,51	2.838,96
450,0	499,0	OF3020450W1E	2.295,96	2.962,86	2.187,87	2.780,99	2.388,23	2.981,32
500,0	549,0	OF3020500W1E	2.372,38	3.060,42	2.298,62	2.920,71	2.498,93	3.121,04
550,0	599,0	OF3020550W1E	2.448,85	3.160,58	2.411,93	3.063,04	2.612,29	3.263,36
600,0	649,0	OF3020600W1E	2.525,28	3.258,09	2.522,68	3.202,74	2.722,99	3.403,05
650,0	699,0	OF3020650W1E	2.604,37	3.358,24	2.628,10	3.337,18	2.828,42	3.537,49
700,0	749,0	OF3020700W1E	2.672,92	3.445,25	2.736,19	3.474,26	2.936,50	3.674,59
750,0	799,0	OF3020750W1E	2.751,98	3.550,69	2.852,16	3.621,86	3.052,48	3.822,21
800,0	849,0	OF3020800W1E	2.831,07	3.650,86	2.960,26	3.758,94	3.160,58	3.959,27
850,0	899,0	OF3020850W1E	2.918,05	3.766,87	3.068,30	3.895,99	3.268,62	4.096,37
900,0	949,0	OF3020900W1E	3.010,32	3.885,47	3.176,37	4.035,74	3.376,72	4.236,05
950,0	999,0	OF3020950W1E	3.099,94	3.998,80	3.287,10	4.175,44	3.487,41	4.375,76
1.000,0	1.049,0	OF3021000W1E	3.192,20	4.120,07	3.387,24	4.304,62	3.587,61	4.504,94
1.050,0	1.099,0	OF3021050W1E	3.287,10	4.241,33	3.503,26	4.446,93	3.703,57	4.647,27
1.100,0	1.149,0	OF3021100W1E	3.374,10	4.352,03	3.608,70	4.584,01	3.809,02	4.784,35
1.150,0	1.199,0	OF3021150W1E	3.450,52	4.452,19	3.719,40	4.723,71	3.919,72	4.924,07
1.200,0	1.249,0	OF3021200W1E	3.555,98	4.589,27	3.864,38	4.905,58	4.064,68	5.105,92
1.250,0	1.299,0	OF3021250W1E	3.669,31	4.731,62	4.006,74	5.090,13	4.207,05	5.290,45
1.300,0	1.349,0	OF3021300W1E	3.774,75	4.868,71	4.151,70	5.272,02	4.352,03	5.472,32
1.350,0	1.399,0	OF3021350W1E	3.885,47	5.011,01	4.294,04	5.453,87	4.494,38	5.654,24
1.400,0	1.449,0	OF3021400W1E	3.990,93	5.148,11	4.439,05	5.635,78	4.639,37	5.836,11
1.450,0	1.499,0	OF3021450W1E	4.096,37	5.285,17	4.584,01	5.820,28	4.784,35	6.020,63
1.500,0	1.549,0	OF3021500W1E	4.209,70	5.430,16	4.726,36	6.002,16	4.926,67	6.202,52
1.550,0	1.599,0	OF3021550W1E	4.312,49	5.561,96	4.871,32	6.184,07	5.071,68	6.384,40
1.600,0	1.649,0	OF3021600W1E	4.407,39	5.685,86	5.013,70	6.368,59	5.214,00	6.568,90
1.650,0	1.699,0	OF3021650W1E	4.504,94	5.809,76	5.158,65	6.550,49	5.359,00	6.750,81
1.700,0	1.749,0	OF3021700W1E	4.597,18	5.930,98	5.303,63	6.732,35	5.503,96	6.932,68
1.750,0	1.799,0	OF3021750W1E	4.710,52	6.075,97	5.446,01	6.916,86	5.646,31	7.117,19
1.800,0	1.849,0	OF3021800W1E	4.829,15	6.231,52	5.590,95	7.098,79	5.791,29	7.299,09
1.850,0	1.899,0	OF3021850W1E	4.950,40	6.387,03	5.733,30	7.280,65	5.933,65	7.480,97
1.900,0	1.949,0	OF3021900W1E	5.071,68	6.542,56	5.878,29	7.467,80	6.078,64	7.668,13
1.950,0	1.999,0	OF3021950W1E	5.195,55	6.703,34	6.023,28	7.649,67	6.223,59	7.850,04
2.000,0	2.032,0	OF3022000W1E	5.322,07	6.864,16	6.165,59	7.831,56	6.365,98	8.031,93

Acoplamiento abierto para tubos de cualquier material sin anclaje axial.

Abierto con bisagra.

Código W1 en NBR termina W1N

Código W2 en EPDM termina W2E
Código W2 en NBR termina W2N

Código W5 en EPDM termina W5E
Código W5 en NBR termina W5N

(1) acoplamiento con anillo interior en acero inoxidable incorporado.

Junta: EPDM: -20°C hasta +100°C NBR: -20°C hasta +80°C

Fluido: EPDM: Todas las calidades de agua, aguas residuales, aire, sólidos y diversos productos químicos.
NBR: Agua, gas, aceite, combustible y otros hidrocarburos.

Especificar 1 o 2 cierres



OPEN FLEX 3 PN 6

desde Ø exterior	hasta Ø exterior	Ref. EPDM	W1 CARCASA GALVANIZADA. CIERRES GALVANIZADOS		W2 CARCASA EN ACERO INOX. CIERRES GALVANIZADOS		W5 CARCASA EN ACERO INOX. CIERRES EN ACERO INOX.	
			€ EPDM	€ NBR	€ EPDM	€ NBR	€ EPDM	€ NBR
219,1	249,0				1.676,51	2.129,90	1.876,82	2.330,22
250,0	299,0				1.742,40	2.211,58	1.942,73	2.411,94
300,0	349,0	OF3060300W1E	2.069,27	2.667,63	1.853,09	2.353,96	2.053,44	2.554,29
350,0	399,0	OF3060350W1E	2.145,70	2.767,81	1.966,46	2.496,27	2.166,79	2.696,66
400,0	449,0	OF3060400W1E	2.222,13	2.865,32	2.077,17	2.638,65	2.277,51	2.838,96
450,0	499,0	OF3060450W1E	2.295,96	2.962,86	2.187,87	2.780,99	2.388,23	2.981,32
500,0	549,0	OF3060500W1E	2.372,38	3.060,42	2.298,62	2.920,71	2.498,93	3.121,04
550,0	599,0	OF3060550W1E	2.448,85	3.160,58	2.411,93	3.063,04	2.612,29	3.263,36
600,0	649,0	OF3060600W1E	2.525,28	3.258,09	2.522,68	3.202,74	2.722,99	3.403,05
650,0	699,0	OF3060650W1E	2.604,37	3.358,24	2.628,10	3.337,18	2.828,42	3.537,49
700,0	749,0	OF3060700W1E	2.672,92	3.445,25	2.736,19	3.474,26	2.936,50	3.674,59
750,0	799,0	OF3060750W1E	2.751,98	3.550,69	2.852,16	3.621,86	3.052,48	3.822,21
800,0	849,0	OF3060800W1E	2.831,07	3.650,86	2.960,26	3.758,94	3.160,58	3.959,27
850,0	899,0	OF3060850W1E	2.918,05	3.766,87	3.068,30	3.895,99	3.268,62	4.096,37
900,0	949,0	OF3060900W1E	3.010,32	3.885,47	3.176,37	4.035,74	3.376,72	4.236,05
950,0	999,0	OF3060950W1E	3.099,94	3.998,80	3.287,10	4.175,44	3.487,41	4.375,76
1.000,0	1.049,0	OF3061000W1E	3.192,20	4.120,07			4.642,54	4.884,51
1.050,0	1.099,0	OF3061050W1E	3.287,10	4.241,33			4.717,20	4.968,15
1.100,0	1.149,0	OF3061100W1E	3.374,10	4.352,03			4.788,91	5.051,81
1.150,0	1.199,0	OF3061150W1E	3.450,52	4.452,19			4.881,52	5.153,38
1.200,0	1.249,0	OF3061200W1E	3.555,98	4.589,27			4.968,15	5.254,93
1.250,0	1.299,0	OF3061250W1E	3.669,31	4.731,62			5.036,87	5.332,63
1.300,0	1.349,0	OF3061300W1E	3.774,75	4.868,71			5.126,50	5.434,21
1.350,0	1.399,0	OF3061350W1E	3.885,47	5.011,01			5.216,13	5.535,77
1.400,0	1.449,0	OF3061400W1E	3.990,93	5.148,11			5.299,76	5.628,39
1.450,0	1.499,0	OF3061450W1E	4.096,37	5.285,17			5.416,29	5.753,86
1.500,0	1.549,0	OF3061500W1E	4.209,70	5.430,16			5.526,84	5.876,37
1.550,0	1.599,0	OF3061550W1E	4.312,49	5.561,96			5.613,46	5.971,94
1.600,0	1.649,0	OF3061600W1E	4.407,39	5.685,86			5.706,06	6.076,51
1.650,0	1.699,0	OF3061650W1E	4.504,94	5.809,76			5.816,61	6.199,02
1.700,0	1.749,0	OF3061700W1E	4.597,18	5.930,98			5.927,14	6.321,48
1.750,0	1.799,0	OF3061750W1E	4.710,52	6.075,97			6.037,67	6.443,97
1.800,0	1.849,0	OF3061800W1E	4.829,15	6.231,52			6.479,82	6.898,06
1.850,0	1.899,0	OF3061850W1E	4.950,40	6.387,03			6.560,47	6.987,70
1.900,0	1.949,0	OF3061900W1E	5.071,68	6.542,56			6.638,17	7.077,32
1.950,0	1.999,0	OF3061950W1E	5.195,55	6.703,34			6.739,73	7.187,86
2.000,0	2.032,0	OF3062000W1E	5.322,07	6.864,16			6.850,26	7.310,34

Acoplamiento abierto para tubos de cualquier material sin anclaje axial.

Abierto con bisagra.

Código W1 en NBR termina W1N

Código W2 en EPDM termina W2E
Código W2 en NBR termina W2N

Código W5 en EPDM termina W5E
Código W5 en NBR termina W5N

En caso de pedido indicar el diámetro exterior exacto

Junta: EPDM: -20°C hasta +100°C NBR: -20°C hasta +80°C

Fluido: EPDM: Todas las calidades de agua, aguas residuales, aire, sólidos y diversos productos químicos.
NBR: Agua, gas, aceite, combustible y otros hidrocarburos.

Especificar 1 o 2 cierres



OPEN FLEX 3 PN 10

desde Ø exterior	hasta Ø exterior	Ref. EPDM	W1 CARCASA GALVANIZADA. CIERRES GALVANIZADOS		W2 CARCASA EN ACERO INOX. CIERRES GALVANIZADOS		W5 CARCASA EN ACERO INOX. CIERRES EN ACERO INOX.	
			€ EPDM	€ NBR	€ EPDM	€ NBR	€ EPDM	€ NBR
219,1	249,0				1.676,51	2.129,90	1.876,82	2.330,22
250,0	299,0				1.742,40	2.211,58	1.942,73	2.411,94
300,0	349,0	OF3100300W1E	2.069,27	2.667,63	1.853,09	2.353,96	2.053,44	2.554,29
350,0	399,0	OF3100350W1E	2.145,70	2.767,81	1.966,46	2.496,27	2.166,79	2.696,66
400,0	449,0	OF3100400W1E	2.222,13	2.865,32	2.077,17	2.638,65	2.277,51	2.838,96
450,0	499,0	OF3100450W1E	2.295,96	2.962,86	2.187,87	2.780,99	2.388,23	2.981,32
500,0	549,0	OF3100500W1E	2.372,38	3.060,42			3.653,69	3.779,15
525,0	549,0						3.710,42	3.841,90
550,0	599,0	OF3100550W1E	2.448,85	3.160,58			3.773,18	3.907,61
575,0	599,0						3.829,93	3.973,31
600,0	649,0	OF3100600W1E	2.525,28	3.258,09			3.916,59	4.071,91
650,0	699,0	OF3100650W1E	2.604,37	3.358,24			3.991,24	4.155,59
700,0	749,0	OF3100700W1E	2.672,92	3.445,25			4.062,93	4.236,23
750,0	799,0	OF3100750W1E	2.751,98	3.550,69			4.137,67	4.325,86
800,0	849,0	OF3100800W1E	2.831,07	3.650,86			4.215,30	4.412,48
850,0	899,0	OF3100850W1E	2.918,05	3.766,87			4.337,80	4.543,94
900,0	949,0	OF3100900W1E	3.010,32	3.885,47			4.457,30	4.681,35
950,0	999,0	OF3100950W1E	3.099,94	3.998,80			4.555,87	4.785,93
1.000,0	1.049,0	OF3101000W1E	3.192,20	4.120,07			4.642,54	4.884,51
1.050,0	1.099,0	OF3101050W1E	3.287,10	4.241,33			4.717,20	4.968,15
1.100,0	1.149,0	OF3101100W1E	3.374,10	4.352,03			4.788,91	5.051,81
1.150,0	1.199,0	OF3101150W1E	3.450,52	4.452,19			4.881,52	5.153,38
1.200,0	1.249,0	OF3101200W1E	3.555,98	4.589,27			4.968,15	5.254,93
1.250,0	1.299,0	OF3101250W1E	7.779,38	8.490,38			5.036,87	5.332,63
1.300,0	1.349,0	OF3101300W1E	7.892,90	8.615,84			5.126,50	5.434,21
1.350,0	1.399,0	OF3101350W1E	7.997,45	8.732,36			5.216,13	5.535,77
1.400,0	1.449,0	OF3101400W1E	8.110,98	8.860,84			5.299,76	5.628,39
1.450,0	1.499,0	OF3101450W1E	8.224,51	8.989,31			Consultar	Consultar
1.500,0	1.549,0	OF3101500W1E	8.332,06	9.108,78				
1.550,0	1.599,0	OF3101550W1E	8.442,59	9.234,26				
1.600,0	1.649,0	OF3101600W1E	8.550,15	9.353,77				
1.650,0	1.699,0	OF3101650W1E	8.663,68	9.479,24				
1.700,0	1.749,0	OF3101700W1E	8.771,20	9.601,69				
1.750,0	1.799,0	OF3101750W1E	8.884,72	9.727,18				
1.800,0	1.849,0	OF3101800W1E	8.989,31	9.846,71				
1.850,0	1.899,0	OF3101850W1E	9.102,83	9.972,20				
1.900,0	1.949,0	OF3101900W1E	9.210,37	10.091,69				
1.950,0	1.999,0	OF3101950W1E	9.323,86	10.220,12				
2.000,0	2.032,0	OF3102000W1E	9.428,45	10.336,64				

Acoplamiento abierto para tubos de cualquier material sin anclaje axial.

Abierto con bisagra.

Código W1 en NBR termina W1N

Código W2 en EPDM termina W2E
Código W2 en NBR termina W2N

Código W5 en EPDM termina W5E
Código W5 en NBR termina W5N

En caso de pedido indicar el diámetro exterior exacto

Junta: EPDM: -20°C hasta +100°C NBR: -20°C hasta +80°C

Fluido: EPDM: Todas las calidades de agua, aguas residuales, aire, sólidos y diversos productos químicos.

NBR: Agua, gas, aceite, combustible y otros hidrocarburos.

Especificar 1 o 2 cierres



OPEN FLEX 3 PN 16

desde Ø exterior	hasta Ø exterior	Ref. EPDM	W1 CARCASA GALVANIZADA. CIERRES GALVANIZADOS		W2 CARCASA EN ACERO INOX. CIERRES GALVANIZADOS		W5 CARCASA EN ACERO INOX. CIERRES EN ACERO INOX.	
			€ EPDM	€ NBR	€ EPDM	€ NBR	€ EPDM	€ NBR
219,0	249,0				1.676,51	2.129,90	1.876,82	2.330,22
250,0	299,0				1.742,40	2.211,58	1.942,73	2.411,94
300,0	349,0	OF3160300W1E	2.069,27	2.667,63	1.853,09	2.353,96	2.053,44	2.554,29
350,0	399,0	OF3160350W1E	2.145,70	2.767,81			3.292,17	3.384,81
375,0	399,0						3.357,93	3.456,52
400,0	449,0	OF3160400W1E	2.222,13	2.865,32			3.414,68	3.519,25
425,0	449,0						3.474,42	3.584,97
450,0	499,0	OF3160450W1E	2.295,96	2.962,86			3.534,16	3.650,68
475,0	499,0						3.593,92	3.713,41
500,0	549,0	OF3160500W1E	2.372,38	3.060,42			3.653,69	3.779,15
525,0	549,0						3.710,42	3.841,90
550,0	599,0	OF3160550W1E	2.448,85	3.160,58			3.773,18	3.907,61
575,0	599,0						3.829,93	3.973,31
600,0	649,0	OF3160600W1E	2.525,28	3.258,09			3.916,59	4.071,91
650,0	699,0	OF3160650W1E	2.604,37	3.358,24			3.991,24	4.155,59
700,0	749,0	OF3160700W1E	2.672,92	3.445,25			4.062,93	4.236,23
750,0	799,0	OF3160750W1E	6.303,54	6.880,16			4.137,67	4.325,86
800,0	849,0	OF3160800W1E	6.420,07	7.005,64			4.215,30	4.412,48
850,0	899,0	OF3160850W1E	6.527,60	7.125,10			Consultar	Consultar
900,0	949,0	OF3160900W1E	6.638,17	7.253,57				
950,0	999,0	OF3160950W1E	6.745,73	7.373,09				
1.000,0	1.049,0	OF3161000W1E	6.859,22	7.498,58				
1.050,0	1.099,0	OF3161050W1E	6.972,76	7.627,00				
1.100,0	1.149,0	OF3161100W1E	7.447,76	8.113,96				
1.150,0	1.199,0	OF3161150W1E	7.561,28	8.239,43				
1.200,0	1.249,0	OF3161200W1E	7.665,84	8.361,92				
1.250,0	1.299,0	OF3161250W1E	7.779,38	8.490,38				
1.300,0	1.349,0	OF3161300W1E	7.892,90	8.615,84				
1.350,0	1.399,0	OF3161350W1E	7.997,45	8.732,36				
1.400,0	1.449,0	OF3161400W1E	8.110,98	8.860,84				
1.450,0	1.499,0	OF3161450W1E	8.224,51	8.989,31				
1.500,0	1.549,0	OF3161500W1E	8.332,06	9.108,78				
1.550,0	1.599,0	OF3161550W1E	Consultar	Consultar				

Acoplamiento abierto para tubos de cualquier material sin anclaje axial.

Abierto con bisagra.

Código W1 en NBR termina W1N

Código W2 en EPDM termina W2E

Código W5 en EPDM termina W5E

Código W2 en NBR termina W2N

Código W5 en NBR termina W5N

En caso de pedido indicar el diámetro exterior exacto

Junta: EPDM: -20°C hasta +100°C NBR: -20°C hasta +80°C

Fluido: EPDM: Todas las calidades de agua, aguas residuales, aire, sólidos y diversos productos químicos.

NBR: Agua, gas, aceite, combustible y otros hidrocarburos.

Especificar 1 o 2 cierres



OPEN FLEX 3 PN 20

W1 CARCASA GALVANIZADA. CIERRES GALVANIZADOS

W5 CARCASA EN ACERO INOX. CIERRES EN ACERO INOX.

desde Ø exterior	hasta Ø exterior	Ref. EPDM	€ EPDM	Ref. NBR	€ NBR	Ref. EPDM	€ EPDM	Ref. NBR	€ NBR
323,9	349,0	OF3200323W1E	2.069,27	OF3200323W1N	2.667,63	OF3200323W5E	3.232,44	OF3200323W5N	3.319,06
350,0	399,0	OF3200350W1E	2.145,70	OF3200350W1N	2.767,81	OF3200350W5E	3.292,17	OF3200350W5N	3.384,81
375,0	399,0					OF3200375W5E	3.357,93	OF3200375W5N	3.456,52
400,0	449,0	OF3200400W1E	2.222,13	OF3200400W1N	2.865,32	OF3200400W5E	3.414,68	OF3200400W5N	3.519,25
425,0	449,0					OF3200425W5E	3.474,42	OF3200425W5N	3.584,97
450,0	499,0	OF3200450W1E	2.295,96	OF3200450W1N	2.962,86	OF3200450W5E	3.534,16	OF3200450W5N	3.650,68
475,0	499,0					OF3200475W5E	3.593,92	OF3200475W5N	3.713,41
500,0	549,0	OF3200500W1E	2.372,38	OF3200500W1N	3.060,42	OF3200500W5E	3.653,69	OF3200500W5N	3.779,15
525,0	549,0					OF3200525W5E	3.710,42	OF3200525W5N	3.841,90
550,0	599,0	OF3200550W1E	5.924,15	OF3200550W1N	6.449,94	OF3200550W5E	3.773,18	OF3200550W5N	3.907,61
575,0	599,0					OF3200575W5E	3.829,93	OF3200575W5N	3.973,31
600,0	649,0	OF3200600W1E	5.980,90	OF3200600W1N	6.518,64	OF3200600W5E	3.916,59	OF3200600W5N	4.071,91
650,0	699,0	OF3200650W1E	6.085,48	OF3200650W1N	6.638,17	OF3200650W5E	Consultar	OF3200650W5N	Consultar
700,0	749,0	OF3200700W1E	6.199,02	OF3200700W1N	6.763,64				
750,0	799,0	OF3200750W1E	6.303,54	OF3200750W1N	6.880,16				
800,0	849,0	OF3200800W1E	6.420,07	OF3200800W1N	7.005,64				
850,0	899,0	OF3200850W1E	6.527,60	OF3200850W1N	7.125,10				
900,0	949,0	OF3200900W1E	6.638,17	OF3200900W1N	7.253,57				
950,0	999,0	OF3200950W1E	6.745,73	OF3200950W1N	7.373,09				
1.000,0	1.049,0	OF3201000W1E	6.859,22	OF3201000W1N	7.498,58				
1.050,0	1.099,0	OF3201050W1E	6.972,76	OF3201050W1N	7.627,00				
1.100,0	1.149,0	OF3201100W1E	7.447,76	OF3201100W1N	8.113,96				
1.150,0	1.199,0	OF3201150W1E	Consultar	OF3201150W1N	Consultar				

Acoplamiento abierto para tubos de cualquier material sin anclaje axial. Abierto con bisagra.

En caso de pedido indicar el diámetro exterior exacto.
 Junta: EPDM: -20°C hasta +100°C NBR: -20°C hasta +80°C
 Fluido: EPDM: Todas las calidades de agua, aguas residuales, aire, sólidos y diversos productos químicos.
 NBR: Agua, gas, aceite, combustible y otros hidrocarburos.
 Especificar 1 o 2 cierres



OPEN FLEX 3 PN 25

W1 CARCASA GALVANIZADA. CIERRES GALVANIZADOS

W5 CARCASA EN ACERO INOX. CIERRES EN ACERO INOX.

desde Ø exterior	hasta Ø exterior	Ref. EPDM	€ EPDM	Ref. NBR	€ NBR	Ref. EPDM	€ EPDM	Ref. NBR	€ NBR
323,9	349,0	OF3250323W1E	2.069,27	OF3250323W1N	2.667,63	OF3250323W5E	3.232,44	OF3250323W5N	3.319,06
350,0	399,0	OF3250350W1E	2.145,70	OF3250350W1N	2.767,81	OF3250350W5E	3.292,17	OF3250350W5N	3.384,81
375,0	399,0					OF3250375W5E	3.357,93	OF3250375W5N	3.456,52
400,0	449,0	OF3250400W1E	2.222,13	OF3250400W1N	2.865,32	OF3250400W5E	3.414,68	OF3250400W5N	3.519,25
425,0	449,0					OF3250425W5E	3.474,42	OF3250425W5N	3.584,97
450,0	499,0	OF3250450W1E	2.295,96	OF3250450W1N	2.962,86	OF3250450W5E	3.534,16	OF3250450W5N	3.650,68
475,0	499,0					OF3250475W5E	3.593,92	OF3250475W5N	3.713,41
500,0	549,0	OF3250550W1E	Consultar	OF3250550W1N	Consultar	OF3250500W5E	Consultar	OF3250500W5N	Consultar
550,0	599,0	OF3250600W1E	5.924,15	OF3250600W1N	6.449,94				
600,0	649,0	OF3250650W1E	5.980,90	OF3250650W1N	6.518,64				
650,0	699,0	OF3250700W1E	6.085,48	OF3250700W1N	6.638,17				
700,0	749,0	OF3250750W1E	6.199,02	OF3250750W1N	6.763,64				
750,0	799,0	OF3250800W1E	6.303,54	OF3250800W1N	6.880,16				
800,0	849,0	OF3250850W1E	6.420,07	OF3250850W1N	7.005,64				
850,0	899,0	OF3250900W1E	6.527,60	OF3250900W1N	7.125,10				
900,0	949,0	OF3250950W1E	6.638,17	OF3250950W1N	7.253,57				
950,0	999,0	OF3201150W1E	Consultar	OF3201150W1N	Consultar				

Acoplamiento abierto para tubos de cualquier material sin anclaje axial. Abierto con bisagra.

En caso de pedido indicar el diámetro exterior exacto.
Junta: EPDM: -20°C hasta +100°C NBR: -20°C hasta +80°C
Fluido: EPDM: Todas las calidades de agua, aguas residuales, aire, sólidos y diversos productos químicos.
 NBR: Agua, gas, aceite, combustible y otros hidrocarburos.
 Especificar 1 o 2 cierres



STEP FLEX 2

CARCASA GALVANIZADA / ACERO INOXIDABLE

Ø exterior tubo 1	Ø exterior tubo 2	Ref. EPDM	€ EPDM
219,1	230 - 250	STF2219E	CONSULTAR
250,0	220 - 280	STF2250E	CONSULTAR
267,0	237 - 297	STF2267E	CONSULTAR
273,0	243 - 303	STF2273E	CONSULTAR
304,0	274 - 334	STF2304E	CONSULTAR
323,9	293 - 353	STF2323E	CONSULTAR
355,6	325 - 385	STF2355E	CONSULTAR
406,4	376 - 436	STF2406E	CONSULTAR
457,2	427 - 487	STF2457E	CONSULTAR
508,0	478 - 538	STF2508E	CONSULTAR
558,8	528 - 588	STF2558E	CONSULTAR
609,6	579 - 639	STF2609E	CONSULTAR
711,2	681 - 741	STF2711E	CONSULTAR
762,0	732 - 792	STF2762E	CONSULTAR
812,8	782 - 842	STF2812E	CONSULTAR

Acoplamiento para tubos de cualquier material sin anclaje axial.

Unión para tuberías de diferentes materiales y diámetros.

Junta: EPDM: -20°C hasta +100°C

Fluido: EPDM: Todas las calidades de agua, aguas residuales, aire, sólidos y diversos productos químicos.



STEP FLEX 3

CARCASA GALVANIZADA / ACERO INOXIDABLE

Ø exterior tubo 1	Ø exterior tubo 2	Ref. EPDM	€ EPDM
914,4	884 - 944	STF30914E	CONSULTAR
1.016,0	986 - 1046	STF31016E	CONSULTAR
1.117,6	1087 - 1147	STF31117E	CONSULTAR
1.219,2	1.189 - 1.249	STF31219E	CONSULTAR
1.320,8	1.290 - 1.350	STF31320E	CONSULTAR
1.422,4	1.392 - 1.452	STF31422E	CONSULTAR
1.524,0	1.494 - 1.554	STF31524E	CONSULTAR
1.600,0	1.570 - 1.630	STF31600E	CONSULTAR
1.625,4	1.595 - 1.655	STF31625E	CONSULTAR
1.727,2	1.697 - 1.757	STF31727E	CONSULTAR
1.828,8	1.798 - 1.858	STF31828E	CONSULTAR
1.930,4	1.900 - 1.960	STF31930E	CONSULTAR
2.032,0	2.002 - 2.062	STF32032E	CONSULTAR

Acoplamiento para tubos de cualquier material sin anclaje axial.

Unión para tuberías de diferentes materiales y diámetros.

Junta: EPDM: -20°C hasta +100°C

Fluido: EPDM: Todas las calidades de agua, aguas residuales, aire, sólidos y diversos productos químicos.



STRAUB CLAMP

ABRAZADERAS SIMPLES DE REPARACIÓN / SCE / LONGITUD 200

Tolerancia (mm)	Código EPDM	€/Un. EPDM	Código NBR	€/Un. NBR
44-48	391-044-200	135,77	381-044-200	123,33
48-52	391-048-200	137,36	381-048-200	124,83
54-58	391-054-200	137,36	381-054-200	124,83
60-67	391-060-200	138,90	381-060-200	126,41
67-74	391-067-200	143,57	381-067-200	131,14
70-77	391-070-200	148,30	381-070-200	135,77
75-81	391-075-200	159,19	381-075-200	140,49
82-89	391-082-200	162,27	381-082-200	143,57
87-95	391-087-200	165,45	381-087-200	148,30
88-95	391-088-200	168,58	381-088-200	152,92
95-104	391-095-200	173,25	381-095-200	159,19
108-118	391-108-200	182,64	381-108-200	166,98
113-123	391-113-200	187,27	381-113-200	171,71
118-128	391-118-200	191,99	381-118-200	174,79
120-131	391-120-200	195,08	381-120-200	179,42
132-142	391-132-200	206,06	381-132-200	187,27
135-145	391-135-200	213,82	381-135-200	191,99
139-149	391-139-200	213,82	381-139-200	191,99
145-155	391-145-200	220,08	381-145-200	195,08
159-170	391-159-200	226,29	381-159-200	204,42
167-178	391-167-200	230,97	381-167-200	210,63
176-187	391-176-200	240,36	381-176-200	220,08
193-203	391-193-200	249,71	381-193-200	229,42
215-225	391-215-200	263,78	381-215-200	240,36
228-239	391-228-200	271,53	381-228-200	246,58
240-250	391-240-200	282,47	381-240-200	252,84
261-271	391-261-200	291,81	381-261-200	265,32
269-280	391-269-200	296,49	381-269-200	269,99

Material: Acero inoxidable AISI 304.

Juntas: EPDM o NBR.



STRAUB CLAMP

ABRAZADERAS SIMPLES DE REPARACIÓN / SCE / LONGITUD 300

Tolerancia (mm)	Código EPDM	€/Un. EPDM	Código NBR	€/Un. NBR
44-48	391-044-300	152,92	381-044-300	137,36
48-52	391-048-300	160,77	381-048-300	141,98
54-58	391-054-300	163,90	381-054-300	146,75
60-67	391-060-300	206,06	381-060-300	187,27
67-74	391-067-300	220,08	381-067-300	195,08
70-77	391-070-300	223,21	381-070-300	199,74
75-81	391-075-300	227,84	381-075-300	206,06
82-89	391-082-300	237,18	381-082-300	218,48
87-95	391-087-300	240,36	381-087-300	220,08
88-95	391-088-300	243,50	381-088-300	223,21
95-104	391-095-300	249,71	381-095-300	229,42
108-118	391-108-300	263,78	381-108-300	240,36
113-123	391-113-300	271,53	381-113-300	246,58
118-128	391-118-300	285,60	381-118-300	255,97
120-131	391-120-300	288,73	381-120-300	262,18
132-142	391-132-300	301,21	381-132-300	273,12
135-145	391-135-300	313,64	381-135-300	287,15
139-149	391-139-300	313,64	381-139-300	287,15
145-155	391-145-300	319,91	381-145-300	291,81
159-170	391-159-300	335,56	381-159-300	304,29
167-178	391-167-300	343,32	381-167-300	309,02
176-187	391-176-300	355,89	381-176-300	323,09
193-203	391-193-300	366,78	381-193-300	333,97
215-225	391-215-300	396,41	381-215-300	358,98
228-239	391-228-300	418,24	381-228-300	379,25
240-250	391-240-300	449,45	381-240-300	408,88
261-271	391-261-300	465,11	381-261-300	421,32
269-280	391-269-300	500,95	381-269-300	455,66
280-291	391-280-300	505,63	381-280-300	461,98
315-325	391-315-300	594,62	381-315-300	540,03
320-330	391-320-300	613,30	381-320-300	557,18

Material: Acero inoxidable AISI 304.

Juntas: EPDM o NBR.



STRAUB CLAMP

ABRAZADERAS SIMPLES DE REPARACIÓN / SCE / LONGITUD 400

Tolerancia (mm)	Código EPDM	€/Un. EPDM	Código NBR	€/Un. NBR
82-89	391-082-400	307,47	381-082-400	282,47
87-95	391-087-400	313,64	381-087-400	287,15
88-95	391-088-400	315,28	381-088-400	288,73
95-104	391-095-400	330,89	381-095-400	301,21
108-118	391-108-400	351,12	381-108-400	316,81
113-123	391-113-400	355,89	381-113-400	323,09
118-128	391-118-400	363,60	381-118-400	330,89
120-131	391-120-400	366,78	381-120-400	333,97
132-142	391-132-400	387,06	381-132-400	352,72
135-145	391-135-400	391,74	381-135-400	355,89
139-149	391-139-400	397,95	381-139-400	360,46
145-155	391-145-400	410,48	381-145-400	371,41
159-170	391-159-400	432,30	381-159-400	394,82
167-178	391-167-400	449,45	381-167-400	408,88
176-187	391-176-400	454,13	381-176-400	413,56
193-203	391-193-400	482,26	381-193-400	438,52
215-225	391-215-400	519,70	381-215-400	472,87

Material: Acero inoxidable AISI 304.

Juntas: EPDM o NBR.



STRAUB CLAMP

ABRAZADERAS DOBLES DE REPARACIÓN / SCZ / LONGITUD 200

Tolerancia (mm)	Código EPDM	€/Un. EPDM	Código NBR	€/Un. NBR
88-108	392-088-200	285,60	382-088-200	255,97
100-120	392-100-200	290,28	382-100-200	263,78
108-128	392-108-200	298,13	382-108-200	271,53
114-134	392-114-200	301,21	382-114-200	273,12
120-140	392-120-200	304,29	382-120-200	277,79
130-150	392-130-200	310,55	382-130-200	285,60
140-160	392-140-200	319,91	382-140-200	291,81
159-180	392-159-200	326,17	382-159-200	296,49
168-189	392-168-200	335,56	382-168-200	304,29
190-210	392-190-200	355,89	382-190-200	323,09
210-230	392-210-200	369,86	382-210-200	337,06
218-238	392-218-200	385,48	382-218-200	351,12
240-260	392-240-200	411,97	382-240-200	373,04
269-289	392-269-200	482,26	382-269-200	438,52
282-302	392-282-200	497,87	382-282-200	452,58
315-335	392-315-200	521,24	382-315-200	474,45

Material: Acero inoxidable AISI 304.

Juntas: EPDM o NBR.



STRAUB CLAMP

ABRAZADERAS DOBLES DE REPARACIÓN / SCZ / LONGITUD 300

Tolerancia (mm)	Código EPDM	€/Un. EPDM	Código NBR	€/Un. NBR
88-108	392-088-300	411,97	382-100-300	385,48
100-120	392-100-300	422,96	382-108-300	750,50
108-128	392-108-300	427,63	382-114-300	402,67
114-134	392-114-300	441,69	382-120-300	408,88
120-140	392-120-300	449,45	382-130-300	413,56
130-150	392-130-300	454,13	382-140-300	427,63
140-160	392-140-300	471,32	382-159-300	438,52
159-180	392-159-300	482,26	382-168-300	452,58
168-189	392-168-300	497,87	382-190-300	474,45
190-210	392-190-300	521,24	382-210-300	494,74
210-230	392-210-300	543,12	382-218-300	505,63
218-238	392-218-300	558,72	382-240-300	543,12
240-260	392-240-300	599,28	382-269-300	639,80
269-289	392-269-300	703,89	382-282-300	660,19
282-302	392-282-300	727,29	382-315-300	685,09
315-335	392-315-300	753,79	382-315-300	685,09
322-344	392-322-300	764,68	382-322-300	696,03
337-358	392-337-300	785,02	382-337-300	711,64
347-367	392-347-300	794,36	382-347-300	722,53

Material: Acero inoxidable AISI 304.

Juntas: EPDM o NBR.



STRAUB CLAMP

ABRAZADERAS DOBLES DE REPARACIÓN / SCZ / LONGITUD 400

Tolerancia (mm)	Código EPDM	€/Un. EPDM	Código NBR	€/Un. NBR
88-108	392-088-400	538,39	382-088-400	488,48
100-120	392-100-400	555,54	382-100-400	504,08
108-128	392-108-400	561,81	382-108-400	511,89
114-134	392-114-400	572,75	382-114-400	519,70
120-140	392-120-400	585,22	382-120-400	532,23
130-150	392-130-400	594,62	382-130-400	540,03
140-160	392-140-400	613,30	382-140-400	557,18
159-180	392-159-400	628,96	382-159-400	572,75
168-189	392-168-400	639,80	382-168-400	580,54
190-210	392-190-400	682,01	382-190-400	619,57
210-230	392-210-400	711,64	382-210-400	647,66
218-238	392-218-400	728,79	382-218-400	661,68
240-260	392-240-400	789,68	382-240-400	717,95
269-289	392-269-400	917,64	382-269-400	834,93
282-302	392-282-400	947,28	382-282-400	861,52
315-335	392-315-400	972,28	382-315-400	883,35
322-344	392-322-400	991,02	382-322-400	902,09
337-358	392-337-400	1.020,65	382-337-400	928,58
347-367	392-347-400	1.048,75	382-347-400	950,41
365-385	392-365-400	1.090,85	382-365-400	991,02
390-410	392-390-400	1.131,46	382-390-400	1.028,51
410-430	392-410-400	1.159,55	382-410-400	1.055,01
420-440	392-420-400	1.176,76	382-420-400	1.069,07

Material: Acero inoxidable AISI 304.

Juntas: EPDM o NBR.

0811 (0809*)

Accesorios

Conectores

Accesorios para válvulas manuales

Actuadores y accesorios

Accesorios válvulas de membrana (*)

0811

Recambios

Válvulas manuales

Válvulas automáticas

Uniones 3 piezas

Flujómetros



Accesorios y recambios

INDUSTRIA





Accesorio y recambios



**CVDE**

d	Ref.	Para válvulas	€
20	CVDE11020		6,05
25	CVDE11025		6,18
32	CVDE11032	VKD-VKR-TKD	6,28
40	CVDE11040	VEE-VXE-SXE SSE-RV-VV-VR	9,83
50	CVDE11050		11,67
63	CVDE11063		16,56
75	CVDE11075	VKD-VEE-VXE-SX/SSE	46,57
90	CVDE11090	VKD	60,53
90	CVDE11090VXE	VEE-VXE-SXE-SSE	60,53
110	CVDE11110	VKD	69,73
110	CVDE11110VXE	VEE-VXE-SXE-SSE	70,41

Conector final en PE100 SDR11.

Para soldadura a testa o electrofusión.**Q/BBE-L**

d	Ref.	Para válvulas	€
20	QBBEL11020	DK	8,39
25	QBBEL11025	DK	9,88
32	QBBEL11032	DK	12,58
40	QBBEL11040	DK	16,03
50	QBBEL11050	DK	16,56
63	QBBEL11063	DK	24,11

Conector final en PE100 SDR11.

*Para soldadura a testa o electrofusión.***ACCESORIOS PARA VÁLVULAS MANUALES****MANGUITO**

d	Ref.	DN	€ PVC-U
16	ENDIV016	10	6,55
20	ENDIV020	15	6,55
25	ENDIV025	20	7,85
32	ENDIV032	25	8,93
40	ENDIV040	32	10,69
50	ENDIV050	40	12,33
63	ENDIV063	50	16,19
75	ENDIV075	65	29,37
90	ENDIV090	80	36,37
90	ENDIV090VXE *	80	36,37
110	ENDIV110	100	61,43
110	ENDIV110VXE *	100	61,43

Manguito encolar H.

*Para válvulas VKD-VKR-TKD-VXE-VEE-SXE-SSE-RV-VR-VV.*** Para válvulas VEE-VXE-SXE-SSE.*

Para recambios de las válvulas consultar el último apartado "Recambios" de esta misma tarifa.

**MANGUITO**

d	Ref.	DN	€ PVC-U
16	ENDDV016	10	6,49
20	ENDDV020	15	6,55
25	ENDDV025	20	7,85
32	ENDDV032	25	8,93
40	ENDDV040	32	10,69
50	ENDDV050	40	12,33
63	ENDDV063	50	16,19
75	ENDDV075	65	28,52
90	ENDDV090	80	35,26
110	ENDDV110	100	61,43

Manguito encolar M.

Para válvulas VKD-VKR-TKD-VXE-VEE-SXE-SSE-RV-VR-VV.

**PSKD**

d	Ref.	DN	Ø tubo	€
16-20	PSKD020	10-15	25	45,17
25	PSKD025	20	25	46,19
32	PSKD032	25	25	47,37
40	PSKD040	32	32	47,89
50	PSKD050	40	32	49,83
63	PSKD063	50	32	54,98

Eje de extensión.

Tubo no incluido.

Para válvulas de bola VKD-VKR-TKD.

**Power Quick/CP**

d	Ref.	DN	ISO	Cuadrado	€
16-20	PQCP020	10-15	F03-04+	11	42,74
25	PQCP025	20	F03-05+	11	45,38
25	PQCP025F04	20	F04	11	39,41
32	PQCP032	25	F03-05+	11	45,38
32	PQCP032F04	25	F04	11	39,41
40	PQCP040	32	F05-07+	14	51,87
50	PQCP050	40	F05-07+	14	51,87
63	PQCP063	50	F05-07+	14	55,11

Kit de actuación neumático.

Para válvulas VKD-VKR-TKD.

+ Para final de carrera tipo MSKD.

**MANGUITO**

d	Ref.	DN	€ PVC-U
3/8"	ENDFV038	10	6,55
1/2"	ENDFV012	15	6,55
3/4"	ENDFV034	20	7,85
1"	ENDFV100	25	8,93
1 1/4"	ENDFV114	32	10,69
1 1/2"	ENDFV112	40	12,33
2"	ENDFV200	50	16,19
2 1/2"	ENDFV212	65	28,52
3"	ENDFV300	80	35,26
3"	ENDFV300VXE *	80	35,26
4"	ENDFV400	100	60,83
4"	ENDFV400VXE *	100	60,83

Manguito rosca H.

Para válvulas VKD-VKR-TKD-VXE-VEE-SXE-SSE-RV-VR-VV.

* Para válvulas VEE-VXE-SXE-SSE.

VKD

d	Ref.	DN	€
75-110	AKVKD075110	65-100	71,31

Kit de actuación.

Adaptador para actuador.

Para válvulas de bola VKD.

**FK**

d	Ref.	DN	€
50-160	FKADA160	40-150	25,53
225	FKADA225	200	31,05

Kit de actuación.

Adaptador para actuador.

Para válvulas de mariposa FK.

**Power Quick/CE**

d	Ref.	DN	ISO	Cuadrado	€
16-20	PQCE020	10-15	F03-04	14	43,16
25	PQCE025	20	F03-05	14	45,82
25	PQCE025F04	20	F04	14	39,41
32	PQCE032	25	F03-05	14	45,38
32	PQCE032F04	25	F04	14	39,41
40	PQCE040	32	F05-07	14	52,38
50	PQCE050	40	F05-07	14	52,38
63	PQCE063	50	F05-07	14	55,11

Kit de actuación eléctrico.

Para válvulas VKD-VKR-TKD.

Bajo pedido disponemos también de otras medidas y/o estándares, como encolar BS, ASTM, JIS; y rosca NPT y JIS para todas las válvulas.



Power Quick

d	Ref.	DN	€
75	PQE090	65	132,45
90	PQE090	80	132,45
110	PQE110	100	145,68

Adaptador para actuador eléctrico y neumático.

Para válvulas de bola VKD.



LS QUICK KIT

d	Ref.	DN	€
16-20	LSQKIT20	10-15	62,42
25	LSQKIT25	20	66,06
32	LSQKIT32	25	66,06
40	LSQKIT40	32	75,53
50	LSQKIT50	40	75,53
63	LSQKIT63	50	80,25

Accesorios de conexión para final de carrera LSQT.

Para válvulas VKD-TKD.



LS QUICK KIT

d	Ref.	DN	€
75	LSQKIT75160	65	151,98
90	LSQKIT75160	80	151,98
110	LSQKIT75160	100	151,98

Accesorios de conexión para final de carrera LSQT.

Para válvulas VKD.



PMKD

d	Ref.	DN	€
16-32	PMKD1	10-25	11,11
40-63	PMKD2	32-50	12,12

Pletinas de sujeción.

Para válvulas de bola VKD-VKR.



SOPORTE*

d	Ref.	DN	€
16-20	PQCECP020D	10-15	68,86
25	PQCECP025D	20	68,86
32	PQCECP032D	25	68,86
40	PQCECP040D	32	71,43
50	PQCECP050D	40	100,06
63	PQCECP063D	50	100,06

Kit de actuación eléctrico y neumático.

Para válvulas VKD-VKR-TKD.



LS QUICK KIT

d	Ref.	DN	€
50	LSQKITFK5063	40	144,71
63	LSQKITFK5063	50	144,71
75	LSQKITFK75160	65	190,72
90	LSQKITFK75160	80	190,72
110	LSQKITFK75160	100	190,72
140	LSQKITFK75160	125	190,72
160	LSQKITFK75160	150	190,72
225	LSQKIT225	200	163,82

Accesorios de conexión para final de carrera LSQT.

Para válvulas FK.



FINALES DE CARRERA

d	Ref.	DN	€
Todos	LSQTMEC	Todos	196,06

Finales de carrera ELECTROMECÁNICOS IP67.

Para válvulas VKD-TKD-FK.

d	Ref.	DN	€
Todos	LSQTPNP	Todos	330,87

Finales de carrera Inductivos PNP (3 hilos).

Para válvulas VKD-TKD-FK.



PMKD KIT

d	Ref.	DN	€
16-32	KITPMKD1	10-25	15,90
40-63	KITPMKD2	32-50	16,77

Pletinas de sujeción con tornillos e insertos.

Para válvulas de bola VKD-VKR.



INSERTOS

d	Ref.	DN	€
16-32	SINSM04X	10-25	107,34
40-63	SINSM06X	32-50	118,69

Insertos roscados en acero inoxidable.

20 piezas. Para válvulas de bola VKD-VKR.



LCE

d	Ref.	DN	€
16-20	LCE020	10-15	29,61
25	LCE025	20	29,73
32	LCE032	25	31,65
40	LCE040	32	32,67
50	LCE050	40	33,81
63	LCE063	50-65-80-110(VXE y SSE)	43,59

Tapón + Disco para VEE, VXE, SXE y SSE.

Tapón transparente y disco en PVC blanco.



PSE

d	Ref.	DN	Ø tubo	€
75	PSE090	65	63	83,69
90	PSE090	80	63	83,69
110	PSE110	100	63	83,69

Eje de extensión para válvula de bola VEE-VXE.

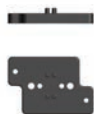

PMDK KIT

d	Ref.	DN	€
20-32	KITPMDK1	15-25	28,77
40-75	KITPMDK2	32-65	27,81

Para válvula de membrana DK.

Paletinas de sujeción con tornillos e insertos.



SHKD

d	Ref.	DN	€
16-20	SHKD020	10-15	20,97
25-32	SHKD032	20-25	23,42
40-50	SHKD050	32-40	27,17
63	SHKD063	50	29,08

Kit de seguridad.

Para válvula VKD y TDK (maneta no incluida).



LSE

d	Ref.	DN	A	B	€
16-20	LSE020	10-15	10	500	99,78
25	LSE025	20	10	500	99,78
32	LSE032	25	10	500	99,78
40	LSE040	32	10	500	99,78
50	LSE050	40	10	400	99,78
63	LSE063	50	10	400	99,78

Etiquetas para VEE y VXE.

Etiquetas blancas troqueladas.

A = Número de hojas
B = Total etiquetas



PMDK

d	Ref.	DN	€
20-32	PMDK1	15-25	22,26
40-75	PMDK2	32-65	25,84

Para válvula de membrana DK.

Paletinas de sujeción.



ZPL

d	Ref.	DN	€
16-20	ZPL2415002	12-15	21,71

Plato separador para válvulas de membrana CM



INDUSTRIA

Accesorios

Actuadores y accesorios



Para válvulas de bola 2 vías VKD.



Ref. 12 V	ACTUACIÓN ELÉCTRICA 24-240 V AC/DC				ACTUACIÓN NEUMÁTICA ALUMINIO				ACTUACIÓN NEUMÁTICA POLIAMIDA			
	AC/DC	€	Ref.	€	DOBLE EFECTO		SIMPLE EFECTO		DOBLE EFECTO		SIMPLE EFECTO	
16	J4CB20	527,72	J4CS20	527,72	CHC052	169,77	CHC052SR	201,40	PPW	186,41	PPWS	210,48
20	J4CB20	527,72	J4CS20	527,72	CHC052	169,77	CHC052SR	201,40	PPW	186,41	PPWS	210,48
25	J4CB20	527,72	J4CS20	527,72	CHC052	169,77	CHC052SR	201,40	PPW	186,41	PPWS	210,48
32	J4CB20	527,72	J4CS20	527,72	CHC052	169,77	CHC052SR	201,40	PPW	186,41	PP00S	318,71
40	J4CB20	527,72	J4CS20	527,72	CHC052	169,77	CHC052SR	201,40	PPW	186,41	PP00S	318,71
50	J4CB20	527,72	J4CS20	527,72	CHC052	169,77	CHC063SR	260,13	PPW	186,41	PP10S	445,01
63	J4CB20	527,72	J4CS20	527,72	CHC052	169,77	CHC075SR	339,00	PP10	375,83	PP10S	445,01
75	J4CB55	797,77	J4CS55	797,77	CHC075	268,06	CHC083SR	387,80	PP10	375,83	PP20S	631,42
90	J4CB55	797,77	J4CS55	797,77	CHC075	268,06	CHC083SR	387,80	PP10	375,83	PP20S	631,42
110	J4CB85	1.172,04	J4CS85	1.172,04	CHC083	294,87	CHC105SR	718,84	PP10	375,83	PP20S	631,42

Para válvulas de bola 3 vías TKD.

16	J4CB20	527,72	J4CS20	527,72	CHC052	169,77	CHC052SR	201,40	PPW	186,41	PPWS	210,48
20	J4CB20	527,72	J4CS20	527,72	CHC052	169,77	CHC052SR	201,40	PPW	186,41	PPWS	210,48
25	J4CB20	527,72	J4CS20	527,72	CHC052	169,77	CHC052SR	201,40	PPW	186,41	PPWS	210,48
32	J4CB20	527,72	J4CS20	527,72	CHC052	169,77	CHC052SR	201,40	PPW	186,41	PP00S	318,71
40	J4CB20	527,72	J4CS20	527,72	CHC052	169,77	CHC063SR	260,13	PPW	186,41	PP10S	445,01
50	J4CB20	527,72	J4CS20	527,72	CHC063	205,52	CHC075SR	339,00	PP00	285,67	PP10S	445,01
63	J4CB20	527,72	J4CS20	527,72	CHC063	205,52	CHC075SR	339,00	PP10	375,83	PP10S	445,01

Para válvulas de mariposa FE.

50	J4CB20	527,72	J4CS20	527,72	CHC052	169,77	CHC063SR	260,13	PP00	285,67	PP10S	445,01
63	J4CB20	527,72	J4CS20	527,72	CHC052	169,77	CHC063SR	260,13	PP00	285,67	PP10S	445,01
75	J4CB55	797,77	J4CS55	797,77	CHC063	205,52	CHC075SR	339,00	PP00	285,67	PP10S	445,01
90	J4CB55	797,77	J4CS55	797,77	CHC075	268,06	CHC083SR	387,80	PP10	375,83	PP10S	445,01
110	J4CB55	797,77	J4CS55	797,77	CHC075	268,06	CHC105SR	718,84	PP10	375,83	PP20S	631,42
140	J4CB85	1.172,04	J4CS85	1.172,04	CHC083	294,87	CHC125SR	972,27	PP10	375,83	PA25S *	917,06
160	J4CB140	1.423,75	J4CS140	1.423,75	CHC083	294,87	CHC125SR	972,27	PP20	702,01	PA25S *	917,06
225	J4CB300	1.546,47	J4CS300	1.546,47	CHC105	554,02	CHC140SR	1.483,75	PP20	702,01	PA30S *	1.353,16
280	J4CB300	1.546,47	J4CS300	1.546,47	CHC125	732,69	CHC190SR	2.703,68	PA30 *	1.345,68	P40ST *	3.674,48
315	J4CB300	1.546,47	J4CS300	1.546,47	CHC140	1.000,78	CHC210SR	3.722,55	PA30 *	1.345,68	P40ST *	3.674,48

Para válvulas de mariposa FK.

50	J4CB20	527,72	J4CS20	527,72	CHC052	169,77	CHC063SR	260,13	PP00	285,67	PP10S	445,01
63	J4CB20	527,72	J4CS20	527,72	CHC052	169,77	CHC063SR	260,13	PP00	285,67	PP10S	445,01
75	J4CB55	797,77	J4CS55	797,77	CHC063	205,52	CHC075SR	339,00	PP00	285,67	PP10S	445,01
90	J4CB55	797,77	J4CS55	797,77	CHC075	268,06	CHC083SR	387,80	PP10	375,83	PP10S	445,01
110	J4CB55	797,77	J4CS55	797,77	CHC075	268,06	CHC105SR	718,84	PP10	375,83	PP20S	631,42
140	J4CB85	1.172,04	J4CS85	1.172,04	CHC083	294,87	CHC125SR	972,27	PP10	375,83	PA25S *	917,06
160	J4CB140	1.423,75	J4CS140	1.423,75	CHC083	294,87	CHC125SR	972,27	PP20	702,01	PA25S *	917,06
225	J4CB300	1.546,47	J4CS300	1.546,47	CHC105	554,02	CHC140SR	1.483,75	PP20	702,01	PA30S *	1.353,16
280	J4CB300	1.546,47	J4CS300	1.546,47	CHC125	732,69	CHC190SR	2.703,68	PA30 *	1.345,68	P40ST *	3.674,48
315	J4CB300	1.546,47	J4CS300	1.546,47	CHC140	1.000,78	CHC210SR	3.722,55	PA30 *	1.345,68	P40ST *	3.674,48
355	ITQ-0800-24	Consultar	ITQ-0800-220	Consultar	CHCN160	Consultar	CHCN210SR	Consultar				
400	ITQ-1100-24	Consultar	ITQ-1100-220	Consultar	CHCN160	Consultar	CHCN240SR	Consultar				

* 24V AC/DC ** 80-240V AC/DC La válvula de mariposa de 140 es la misma que la de 125. Lo mismo sucede con la de 225-200 y la de 280- 250 * Actuadores de aluminio

Reductor manual para válvulas de mariposa FE y FK.

50 - 225 **ILG/D-232/10** 797,77

250 - 315 **ILG/D-550** 1.027,56



Ref.	Modelo	€
BSR2017	Para válvulas de bola \varnothing 16 - 63 mm.	554,69
BSR2017	Para válvulas de bola \varnothing 75 - 90 y mariposa \varnothing 50 - 110 mm.	554,69
BSR2005	Para válvulas de bola \varnothing 110 mm. y mariposa \varnothing 140 - 315 mm.	649,09
BSR2017	Para válvulas de bola 3 vías \varnothing 16 - 63 mm.	554,69

Bloque de seguridad.

Para válvulas con actuador *eléctrico J+J*.

Importe a añadir al precio del actuador.



Ref.	Modelo	€
DPS2017	Para válvulas de bola \varnothing 16 - 63 mm.	619,98
DPS2017	Para válvulas de bola \varnothing 75 - 90 y mariposa \varnothing 50 - 110 mm.	619,98
DPS2005	Para válvulas de bola \varnothing 110 mm. y mariposa \varnothing 140 - 315 mm.	1.094,55
DPS2017	Para válvulas de bola 3 vías \varnothing 16 - 63 mm.	619,98

Posicionador 4-20 mA.

Para válvulas con actuador *eléctrico J+J*.

Importe a añadir al precio del actuador.



Ref.	Modelo	Vías	Voltaje	€
EJ024CA-2008	Electroválvula J+J 2008	5/2	24 V CA	106,22
EJ024CC-2008	Electroválvula J+J 2008	5/2	24 V CC	106,22
EJ048CA-2008	Electroválvula J+J 2008	5/2	48 V CA	106,22
EJ110CA-2008	Electroválvula J+J 2008	5/2	110 V CA	106,22
EJ220CA-2008	Electroválvula J+J 2008	5/2	220V CA	106,22

Electroválvula.

Para válvulas con actuador *neumático CH-AIR*.

3/2 vías consultar.



Ref.	Modelo	€
CB2GC00TAPSS	2 finales de carrera ELECTROMECAÑICOS	94,43

Caja final de carrera electromecánico.

Para válvulas con actuador *neumático CH-AIR*.

Los precios ya incluyen la instalación y montaje sobre el actuador



Ref.	Modelo	€
CB2GP23TAPSS	2 finales de carrera INDUCTIVOS NBB2-V3-E2 3 hilos PNP	306,87
CB2GP41TAPSS	2 finales de carrera INDUCTIVOS NBB2-V3-E0 3 hilos NPN	306,87
CB2GP49TAPS	2 finales de carrera INDUCTIVOS NBB2-V3-Z4 2 hilos no	377,43

Caja final de carrera inductivo.

Para válvulas con actuador *neumático CH-AIR*.

Los precios ya incluyen la instalación y montaje sobre el actuador

YT-1200



YT-1000



YT-2300



Ref.	Modelo	€
YT-1200	Posicionador neumático 3-15 PSI	1.245,06
YT-1000	Posicionador electroneumático 4-20 mA	1.841,05
YT-2300	Posicionador electroneumático 4-20 mA + FEEDBACK 4-20 mA	3.369,34

Posicionador.

Para válvulas con actuador *neumático CH-AIR*.

Los precios ya incluyen la instalación y montaje sobre el actuador



Ref.	Modelo	Vías	Voltaje	€
EV-500.024A	Electroválvula PRISMA NAMUR	3/2 -5/2	24 V CA	129,27
EV-500.024C	Electroválvula PRISMA NAMUR	3/2 -5/2	24 V CC	129,27
EV-500.048A	Electroválvula PRISMA NAMUR	3/2 -5/2	48 V CA	129,27
EV-500.110A	Electroválvula PRISMA NAMUR	3/2 -5/2	110 V CA	129,27
EV-500.220A	Electroválvula PRISMA NAMUR	3/2 -5/2	220V CA	129,27

Electroválvula.

Para válvulas con actuador *neumático PRISMA*.

Ref.	Modelo	€
CFC-5601	2 finales de carrera ELECTROMECAÑICOS	112,92
CFC-5603	4 finales de carrera ELECTROMECAÑICOS	208,76

Caja final de carrera electromecánico **aluminio**.Para válvulas con actuador *neumático PRISMA*.

Los precios ya incluyen la instalación y montaje sobre el actuador.



Ref.	Modelo	€
CFC-5202	2 finales de carrera INDUCTIVOS NAMUR EEXI P+F	327,57
CFC-5204	2 finales de carrera INDUCTIVOS NPN P+F	651,09
CFC-5206	2 finales de carrera INDUCTIVOS PNP P+F	407,11

Caja final de carrera inductivo **aluminio**.
Para válvulas con actuador **neumático PRISMA**.

Los precios ya incluyen la instalación y montaje sobre el actuador



Ref.	Modelo	€
CFC-6301	2 finales de carrera ELECTROMECAÑICOS	148,42
CFC-6302	4 finales de carrera ELECTROMECAÑICOS rec. ORO	149,69

Caja final de carrera electromecánico **plástico**.
Para válvulas con actuador **neumático PRISMA**.

Los precios ya incluyen la instalación y montaje sobre el actuador.



Ref.	Modelo	€
CFC-6321	1 final de carrera INDUCTIVO P+F NBB2-V3-E2 (PNP)	268,71
CFC-6322	2 finales de carrera INDUCTIVOS P+F NBB2-V3-E2 (PNP)	362,90

Caja final de carrera inductivo **plástico**.
Para válvulas con actuador **neumático PRISMA**.

Los precios ya incluyen la instalación y montaje sobre el actuador.



PST-001



PST-003



PST-003

Ref.	Modelo	€
PST-001	Posicionador electroneumático 4-20 mA	1.559,24
PST-002	Posicionador electroneumático 4-20 mA + 2 finales de carrera SPDT	1.960,66
PST-003	Posicionador electroneumático 4-20 mA + 2 finales de carrera SPDT + FEEDBACK 4-20 mA	2.932,82

Posicionador.

Para válvulas con actuador **neumático PRISMA**.

Los precios ya incluyen la instalación y montaje sobre el actuador



DN	Ref.	Tipo de válvula	€
80+100	ZIN005	VM/CP NC-NO-DE	19,28

Indicador óptico de posición.

Con junta y tapón protector.



DN	Ref.	Tipo de válvula	€
15+32	ZLIM001	DK/CP NC	110,11
15+32	ZLIM002	DK/CP NO-DE	125,47
40+65	ZLIM003	DK/CP NC	78,65
40+65	ZLIM004	DK/CP NO-DE	110,11

Limitador de carrera.

Con junta y tapón protector.

Apertura manual
(Montaje en fábrica)



DN	Ref.	Tipo de válvula	€
15+32	ZLI001	DK/CP NC	101,89
15+32	ZLI002	DK/CP NO-DE	90,80
40+65	ZLI003	DK/CP NC	115,50
40+65	ZLI103	DK/CP NO-DE	64,86
12+15	ZLI010	CM/CP NC-NO-DE	126,65
80+100		VM/CP NC-NO *	

Limitador de carrera con indicador
óptico de posición.

Con junta y tapón protector.

* Montaje en fábrica



DN	Ref.	Tipo de válvula	€
15+32	LSLIPNP001	DK/CP	787,63
40+65	LSLIPNP002	DK/CP	787,63
80+100	LSLIPNP003	VM/CP NC	787,63
80+100	LSLIPNP001	VM/CP NO-DA	787,63

Caja finales de carrera inductivos LSLI.

IP68. [2 Conectores electromecánicos.](#)



DN	Ref.	Tipo de válvula	€
15+65	ZMSNAM001	DK/CP NC-NO-DE	518,90
80+100	ZMSNAM004	VM/CP NC	544,51
80	ZMSNAM005	VM/CP NO-DE	544,51
100	ZMSNAM006	VM/CP NO-DE	1.063,79

Caja micro contactos.

IP65. Seguridad: Eex ia IIC T6.

[2 Conectores inductivos NAMUR.](#)



DN	Ref.	Tipo de válvula	€
15+32	LSLIMEC001	DK/CP	437,59
40+65	LSLIMEC002	DK/CP	437,59
80+100	LSLIMEC003	VM/CP NC	437,59
80+100	LSLIMEC001	VM/CP NO-DA	437,59

Caja finales de carrera electromecánicos

LSLI.

IP67. [2 Conectores electromecánicos.](#)



DN	Ref.	Tipo de válvula	€
12+15	ZMSMECCM	CM/CP NC-NO-DE	385,22

Caja micro contactos.

IP65. [2 Conectores electromecánicos.](#)

12+15	ZMSNAMCM	CM/CP NC-NO-DE	880,49
-------	-----------------	----------------	---------------

Caja micro contactos.

IP65. Seguridad: Eex ia IIC T6.

[2 Conectores inductivos NAMUR.](#)



DN	Ref.	Tipo de válvula	€
15+32	ZMSPNPLIM001	DK/CP NC	1.376,47
40	ZMSPNPLIM002	DK/CP NC	983,19
50+65	ZMSPNPLIM003	DK/CP NC	1.376,47
80	ZMSPNPLIM005	VM/CP NC	1.584,74
100	ZMSPNPLIM006	VM/CP NC	1.376,47

Caja micro contactos.

IP65. 2 Sensores inductivos PNP 3 hilos.

Con limitador de carrera.



DN	Ref.	Tipo de válvula	€
15+32	ZMSFC001	DK/CP NC	71,54
40+65	ZMSFC002	DK/CP NC	51,11
80+100	ZMSFC005	VM/CP NC	71,54
12+15	ZMSFC009	CM/CP NC-NO-DE	71,54

Caja micro contactos (24.90).

IP65. 1 Conector electromecánico.



DN	Ref.	Tipo de válvula	€
15+65		DK/CP NC-NO*	1.813,21
80+100		VM/CP NC-NO*	1.813,21

Posicionador electroneumático.

* Montaje en fábrica

SIMPLE EFECTO.

Señal input 4-20 mA. Para válvulas NC-NO.



DN	Ref.	Tipo de válvula	€
15+65		DK/CP DE*	2.236,45
80+100		VM/CP DE*	2.236,45

Posicionador electroneumático.

* Montaje en fábrica

DOBLE EFECTO.

Señal input 4-20 mA. Para válvulas DE.



DN	Ref.	Tipo de válvula	€
15+65	ZMS001	DK/CP NC-NO-DE	626,78
80	ZMS001	VM/CP NC	626,78
12-15	ZMS001	VM/CP NO-DA	626,78
80-100	ZMS002	CM/CP	626,78

Caja micro contactos libres.

IP67. 2 Sensores libres.

Ref.	Cable conexión	€
3CNZMS	5 metros	48,14

Conector "5 conectores" PIN M12 x 1

Para contactos libres.



Ref.	Tipo de válvula	€
SPNC14N024DC	DK-DKB-DKD-VM-CM/CP Voltaje 24V DC	210,96
SPNC14N024AC	DK-DKB-DKD-VM-CM/CP Voltaje 24V AC 50 Hz	210,96
SPNC14N110AC	DK-DKB-DKD-VM-CM/CP Voltaje 110V AC 50 Hz	210,96
SPNC14N220AC	DK-DKB-DKD-VM-CM/CP Voltaje 220V AC 50 Hz	210,96

Válvula piloto SP/NC normalmente cerrada.

Juntas NBR. 3/2 vías.

Rosca H 1/4". Montaje directo.



Ref.	Tipo de válvula	€
SBNC18N024DC	DK-DKB-DKD-VM-CM/CP Voltaje 24V DC	191,29
SBNC18N024AC	DK-DKB-DKD-VM-CM/CP Voltaje 24V AC 50 Hz	191,29
SBNC18N110AC	DK-DKB-DKD-VM-CM/CP Voltaje 110V AC 50 Hz	191,29
SBNC18N220AC	DK-DKB-DKD-VM-CM/CP Voltaje 220V AC 50 Hz	191,29

Válvula piloto SP/NC normalmente cerrada.

Juntas NBR. 3/2 vías.

Rosca H 1/4". Montaje en batería.



Ref.	Tipo de válvula	€
SDNO14N024DC	DK-DKB-DKD-CM/CP Voltaje 24V DC	281,58

Válvula piloto SD/NO normalmente abierta.

Juntas NBR. 3/2 vías.

Rosca H 1/4". Montaje directo.



Ref.	Tipo de válvula	€
SMNO18N024DC	DK-DKB-DKD-CM/CP Voltaje 24V DC	283,64

Válvula piloto SM/NO normalmente abierta.

Juntas NBR. 3/2 vías.

Rosca H 1/8". Montaje en batería.



Ref.	Tipo de válvula	€
2EV024DC	DK-DKB/CP* Voltaje 24V	193,17
2EV024AC	DK-DKB/CP* Voltaje 24V AC 50 Hz	193,17
2EV110AC	DK-DKB/CP* Voltaje 110V AC 50 Hz	193,17
2EV220AC	DK-DKB/CP* Voltaje 220V AC 50 Hz	193,17

Válvula piloto NAMUR "2EV".
NAMUR 3-5/2 vías. Montaje directo.

* Para montar con adaptador
ZAD2428001



DN	Ref.	Tipo de válvula	€
15÷65	ZAD2428001	DK/CP	57,80
15÷65	ZAD2428001	DKB/CP	57,80

Adaptador NAMUR para válvula piloto "2EV".

Conexión NAMUR.

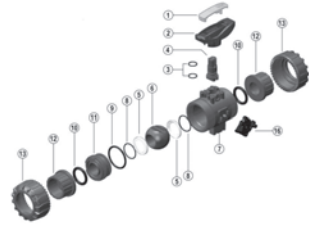

VKD / VKR

Válvula de bola VK DUAL BLOCK® DN10+50.

d	DN	Ref. EPDM	€	Ref. FKM	€
16-20	10-15	SETVKD020E	22,79	SETVKD020F	50,13
25	20	SETVKD025E	27,86	SETVKD025F	51,79
32	25	SETVKD032E	37,77	SETVKD032F	58,86
40	32	SETVKD040E	51,35	SETVKD040F	77,25
50	40	SETVKD050E	61,24	SETVKD050F	92,48
63	50	SETVKD063E	82,08	SETVKD063F	157,14

Juego de juntas y asientos VKD / VKR.

Posiciones 3-5-8-9-10.

d	DN	Ref.	€
16-20	10-15	HSVKD020	16,63
25	20	HSVKD025	18,44
32	25	HSVKD032	19,54
40	32	HSVKD040	20,84
50	40	HSVKD050	23,82
63	50	HSVKD063	30,45

Maneta VKD / VKR.
Posiciones 3-5-8-9-10.

Set maneta VKD / VKR
compuesto por maneta y herramienta de apriete

d	DN	Ref.	€
16-20	10-15	DBVKD020025	23,45
25	20	DBVKD020025	23,45
32	25	DBVKD032	23,45
40	32	DBVKD040050	23,45
50	40	DBVKD040050	23,45
63	50	DBVKD063	23,45

VKD / VKR DUAL BLOCK® kit.
Posición 16.

d	DN	Ref. PVC-U	€	Ref. PP-H	€	Ref. PVDF	€	Ref. C-PVC	€
16-20	10-15	NTVKD020V	10,22	NTVKD020M	13,61	NTVKD020F	74,03	NTVKD020C	19,54
25	20	NTVKD025V	19,33	NTVKD025M	25,99	NTVKD025F	78,20	NTVKD025C	35,78
32	25	NTVKD032V	23,37	NTVKD032M	31,32	NTVKD032F	101,47	NTVKD032C	43,92
40	32	NTVKD040V	25,09	NTVKD040M	34,14	NTVKD040F	137,41	NTVKD040C	48,78
50	40	NTVKD050V	29,68	NTVKD050M	40,22	NTVKD050F	160,63	NTVKD050C	56,94
63	50	NTVKD063V	44,95	NTVKD063M	61,48	NTVKD063F	249,87	NTVKD063C	87,79

Tuerca VKD / VKR.
Posición 13.

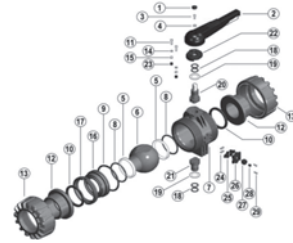

VKD

Válvula de bola VK DUAL BLOCK® DN65+100.

d	DN	Ref. EPDM	€	Ref. FKM	€
75	65	SETVKD075E	157,37	SETVKD075F	294,39
90	80	SETVKD090E	199,74	SETVKD090F	387,89
110	100	SETVKD110E (*)	270,07	SETVKD110F	489,83

Juego de juntas y asientos VKD.

Posiciones 5-8-9-10-18-19.

* No recomendable para la válvula VKD d 110 DN100 en PVDF

d	DN	Ref.	€
75	65	HSFKD0S14	60,19
90	80	HSFKD0M14	76,96
110	100	HSFKD0L17	85,10

Maneta VKD.

Posiciones 1-2-3-4.

Set maneta VKD compuesto por maneta y herramienta de apriete

d	DN	Ref. PVC-U	€	Ref. PP-H	€	Ref. PVDF	€	Ref. C-PVC	€
75	65	NTVKD075V	80,56	NTVKD075M	102,47	NTVKD075F	504,51	NTVKD075C	102,47
90	80	NTVKD090V	103,10	NTVKD090M	116,34	NTVKD090F	997,46	NTVKD090C	188,49
110	100	NTVKD110V	156,37	NTVKD110M	160,78	NTVKD110F	1.161,79	NTVKD110C	294,95

Tuerca VKD.

Posición 13.

d	DN	Ref.	€
75-110	65-100	DBVKD075110	34,14

VKD DUAL BLOCK® kit.

Posiciones 24-25-26-27-28-29.

d	DN	Ref.	€
75-110	65-100	UFFK160	30,19

Brida superior con trinquete VKD.

Posiciones 11-14-15-22-23.

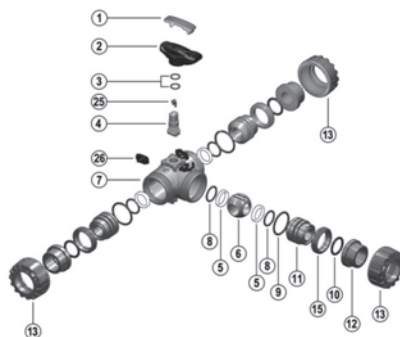

TKD

Válvula de bola 3 vías VK DUAL BLOCK®.

d	DN	Ref. EPDM	€	Ref. FKM	€
16-20	10-15	SETTKD020E	14,95	SETTKD020F	49,22
25	20	SETTKD025E	26,07	SETTKD025F	68,62
32	25	SETTKD032E	28,15	SETTKD032F	84,91
40	32	SETTKD040E	50,74	SETTKD040F	124,02
50	40	SETTKD050E	62,96	SETTKD050F	200,04
63	50	SETTKD063E	83,62	SETTKD063F	253,11

Juego de juntas y asientos TKD.

Posiciones 3-5-8-9-10.

d	DN	Ref.	€	d	DN	Ref.	€	d	DN	Ref.	€
16-20	10-15	HSTKD020	16,63	16-20	10-15	DBTKD020025	23,45	16-20	10-15	PITKD020	2,11
25	20	HSTKD025	18,44	25	20	DBTKD020025	23,45	25	20	PITKD025032	2,11
32	25	HSTKD032	19,54	32	25	DBTKD032040	23,45	32	25	PITKD025032	2,11
40	32	HSTKD040	20,84	40	32	DBTKD032040	23,45	40	32	PITKD040050	2,11
50	40	HSTKD050	23,82	50	40	DBTKD050063	23,45	50	40	PITKD040050	2,11
63	50	HSTKD063	30,45	63	50	DBTKD050063	23,45	63	50	PITKD063	2,11

Maneta TKD.
 Posiciones 1-2.

Maneta y herramienta
 de apriete

TKD DUAL BLOCK® kit.
 Posición 26.

TKD indicador óptico.
 Posición 25.

d	DN	Ref. PVC-U	€	Ref. PP-H	€	Ref. C-PVC	€
16-20	10-15	NTVKD020V	10,22	NTVKD020M	13,61	NTVKD020C	19,54
25	20	NTVKD025V	19,33	NTVKD025M	25,99	NTVKD025C	35,78
32	25	NTVKD032V	23,37	NTVKD032M	31,32	NTVKD032C	43,92
40	32	NTVKD040V	25,09	NTVKD040M	34,14	NTVKD040C	48,78
50	40	NTVKD050V	29,68	NTVKD050M	40,22	NTVKD050C	56,94
63	50	NTVKD063V	44,95	NTVKD063M	61,48	NTVKD063C	87,79

Tuerca VKD.
 Posición 13.

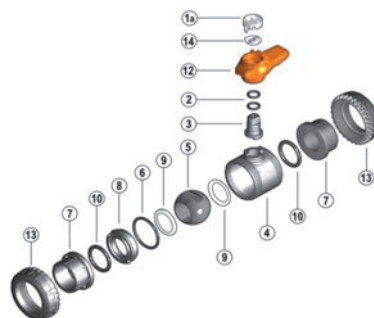

VXE

Válvula de bola VX Easyfit DN15+50.

d	DN	Ref. EPDM	€	Ref. FKM	€
16-20	10-15	SETVX020E	11,14	SETVX020F	32,99
25	20	SETVX025E	14,71	SETVX025F	44,68
32	25	SETVX032E	20,87	SETVX032F	55,43
40	32	SETVX040E	31,43	SETVX040F	86,15
50	40	SETVX050E	36,44	SETVX050F	116,92
63	50	SETVX063E	55,54	SETVX063F	200,27

d	DN	Ref.	€
16-20	10-15	HSVXE020	10,62
25	20	HSVXE025	12,58
32	25	HSVXE032	15,82
40	32	HSVXE040	24,67
50	40	HSVXE050	25,25
63	50	HSVXE063	38,16

Juego de juntas y asientos VXE.
 Posiciones 2-6-9-10.

Set maneta VXE. Maneta y tapón
 Posiciones 1a-12-14.

d	DN	Ref. PVC-U	€
16-20	10-15	NTVXE020V	9,74
25	20	NTVXE025V	10,96
32	25	NTVXE032V	13,15
40	32	NTVXE040V	17,29
50	40	NTVXE050V	21,34
63	50	NTVXE063V	27,81

Ref. C-PVC	€
NTVXE020C	16,19
NTVXE025C	31,03
NTVXE032C	36,66
NTVXE040C	39,90
NTVXE050C	47,70
NTVXE063C	72,07

Tuercas VXE. Posición 13.

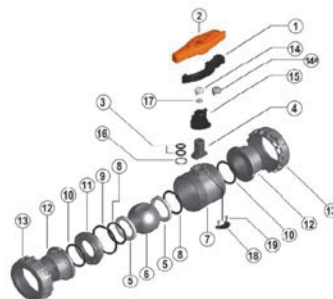

VXE

Válvula de bola VX Easyfit DN65+100.

d	DN	Ref. EPDM	€	Ref. FKM	€
75	65	SETVXE075E	63,36	SETVXE075F	214,48
90	80	SETVXE090E	79,18	SETVXE090F	274,45
110	100	SETVXE110E	94,73	SETVXE110F	331,66

d	DN	Ref.	€
75	65	HSVXE075	57,02
90	80	HSVXE090	57,65
110	100	HSVXE110	75,04

Juego de juntas y asientos VXE.
 Posiciones 3-5-8-9-10-16.

Set maneta VXE. Maneta y tapón
 Posiciones 1-2.

d	DN	Ref. PVC-U	€
75	65	NTVXE075V	80,56
90	80	NTVXE090V	103,10
110	100	NTVXE110V	156,37

Ref. C-PVC	€
NTVXE075C	88,68
NTVXE090C	115,33
NTVXE110C	163,01

Tuercas VXE. Posición 13.



VEE

Válvula de bola VE Easyfit DN15+50.

d	DN	Ref. EPDM	€
16-20	10-15	SETVE020E	4,78
25	20	SETVE025E	5,81
32	25	SETVE032E	8,16
40	32	SETVE040E	11,78
50	40	SETVE050E	17,64
63	50	SETVE063E	21,36

Juego de juntas y asientos VEE.
 Posiciones 2-6-9-10.

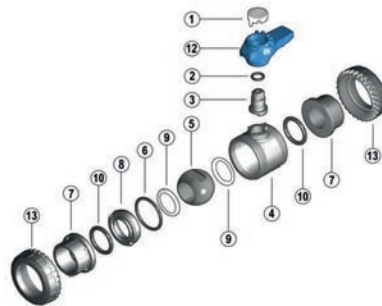

d	DN	Ref.	€
16-20	10-15	HSVEE020	10,62
25	20	HSVEE025	12,58
32	25	HSVEE032	15,82
40	32	HSVEE040	20,87
50	40	HSVEE050	25,25
63	50	HSVEE063	33,54

Maneta VEE.
 Posiciones 1-12.

Set maneta VEE
 compuesto por maneta y tapón



VEE

Válvula de bola VE Easyfit DN65+100.

d	DN	Ref. EPDM	€
75	75	SETVEE075E	22,71
90	90	SETVEE090E	28,10
110	110	SETVEE110E	35,68

Juego de juntas y asientos VEE.
 Posiciones 3-5-8-9-10-16.

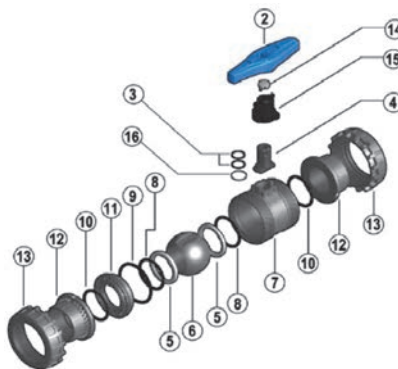

d	DN	Ref.	€
75	75	HAVEE075	42,50
90	90	HAVEE090	47,62
110	110	HAVEE110	54,27

Maneta VEE.
 Posición 2.

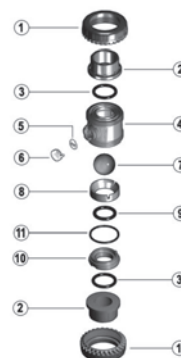

SXE

Válvula anti retorno de bola SX Easyfit DN10+50.

d	DN	Ref. EPDM	€	Ref. FKM	€
16-20	10-15	SETSXE020E	6,63	SETSXE020F	20,31
25	20	SETSXE025E	9,72	SETSXE025F	29,60
32	25	SETSXE032E	11,60	SETSXE032F	32,69
40	32	SETSXE040E	12,07	SETSXE040F	47,91
50	40	SETSXE050E	14,47	SETSXE050F	47,91
63	50	SETSXE063E	27,49	SETSXE063F	104,56

Juego de juntas y asientos SXE. Posiciones 3-9-11.

d	DN	Ref. PVC-U	€
16-20	10-15	BLSR020V	24,13
25	20	BLSR025V	24,13
32	25	BLSR032V	29,51
40	32	BLSR040V	48,27
50	40	BLSR050V	63,03
63	50	BLSR063V	87,85

Bola SXE. Posición 7.

d	DN	Ref. PVC-U	€
16-20	10-15	SESXE020V	4,84
25	20	SESXE025V	6,46
32	25	SESXE032V	5,24
40	32	SESXE040V	9,01
50	40	SESXE050V	7,92
63	50	SESXE063V	18,66

Casquillo SXE. Posición 10.

d	DN	Ref. PVC-U	€
16-20	10-15	PRSXE020V	6,47
25	20	PRSXE025V	7,97
32	25	PRSXE032V	10,80
40	32	PRSXE040V	11,89
50	40	PRSXE050V	14,52
63	50	PRSXE063V	17,22

Anillo de sujeción SXE. Posición 8

d	DN	Ref.	€	d	DN	Ref. PVC-U	€
32	25	LCE020	29,61	16-20	10-15	NTVXE020V	9,74
40	32	LCE025	29,73	25	20	NTVXE025V	10,96
50	40	LCE032	31,65	32	25	NTVXE032V	13,15
63	50	LCE032	31,65	40	32	NTVXE040V	17,29
				50	40	NTVXE050V	21,34
				63	50	NTVXE063V	27,81

Set LCE. Set tapón transparente + disco en PVC blanco (10 piezas de cada por set)
Posiciones 5-6.

Tuerca SXE. Posición 1.

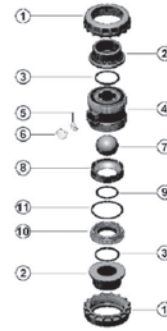

SXE

Válvula anti retorno de bola SX Easyfit DN65+100.

d	DN	Ref. EPDM	€	Ref. FKM	€
75	65	SETSXE075E	52,66	SETSXE075F	166,22
90	80	SETSXE090E	66,05	SETSXE090F	207,35
110	100	SETSXE110E	86,71	SETSXE110F	282,12

Juego de juntas y asientos SXE.

Posiciones 3-9-11.

d	DN	Ref. PVC-U	€
75	65	BLSXE075V	174,51
90	80	BLSXE090V	218,91
110	100	BLSXE110V	287,27

Bola SXE.

Posición 7.

d	DN	Ref. PVC-U	€
75	65	SESXE075V	33,15
90	80	SESXE090V	41,58
110	100	SESXE110V	54,56

Casquillo SXE.

Posición 10.

d	DN	Ref. PVC-U	€
75	65	PRSXE075V	46,08
90	80	PRSXE090V	57,78
110	100	PRSXE110V	75,85

Anillo de sujección SXE.

Posición 8

d	DN	Ref.	€	d	DN	Ref. PVC-U	€	Ref. C-PVC	€
75	65	LCE063	43,59	75	65	NTVXE075V	80,56	NTVXE075C	88,68
90	80	LCE063	43,59	90	80	NTVXE090V	103,10	NTVXE090C	115,33
110	100	LCE063	43,59	110	100	NTVXE110V	156,37	NTVXE110C	163,01

Set LCE. Set tapón transparente + disco en PVC blanco (10 piezas de cada por set)
 Posiciones 5-6.

Tuerca SXE.
 Posición 1.

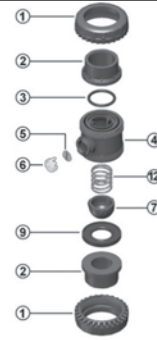

SSE

Válvula anti retorno con muelle SS Easyfit DN10+50.

d	DN	Ref. EPDM	€	Ref. FKM	€
16-20	10-15	SETSSSE020E	5,84	SETSSSE020F	17,14
25	20	SETSSSE025E	8,53	SETSSSE025F	24,96
32	25	SETSSSE032E	10,20	SETSSSE032F	27,57
40	32	SETSSSE040E	10,59	SETSSSE040F	40,41
50	40	SETSSSE050E	12,70	SETSSSE050F	40,41
63	50	SETSSSE063E	24,06	SETSSSE063F	88,11

Juego de juntas SSE.
 Posiciones 3-9.

d	DN	Ref. PVC-U	€	Ref. C-PVC	€
16-20	10-15	NTVXE020V	9,74	NTVXE020C	16,19
25	20	NTVXE025V	10,96	NTVXE025C	31,03
32	25	NTVXE032V	13,15	NTVXE032C	36,66
40	32	NTVXE040V	17,29	NTVXE040C	39,90
50	40	NTVXE050V	21,34	NTVXE050C	47,70
63	50	NTVXE063V	27,81	NTVXE063C	72,07

Tuerca SSE.
 Posición 1.

d	DN	Ref. muelle INOX A316	€	Ref. muelle INOX recubierto PTFE	€	Ref. muelle Hastelloy	€
16-20	10-15	ASSE020VX	23,32			ASSE020VH	69,48
25	20	ASSE025VX	23,32			ASSE025VH	65,34
32	25	ASSE032VX	28,47			ASSE032VH	74,03
40	32	ASSE040VX	46,64	ASSE040V0P	65,84		
50	40	ASSE050VX	60,90	ASSE050V0P	82,35		
63	50	ASSE063VX	84,91	ASSE063V0P	112,91		

Tapón + muelle SSE.
 Posiciones 7-12.

d	DN	Ref.	€
32	25	LCE020	29,61
40	32	LCE025	29,73
50-63	40-50	LCE032	31,65

Tuerca SSE.
 Posición 1.

Set tapón transparente + disco en PVC
 blanco (10 piezas de cada por set)

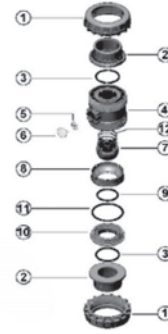

SSE

Válvula anti retorno con muelle SS Easyfit DN65+100.

d	DN	Ref. EPDM	€	Ref. FKM	€	d	DN	Ref.	€
75	65	SETSXE075E	52,66	SETSXE075F	166,22	75	65	LCE063	43,59
90	80	SETSXE090E	66,05	SETSXE090F	207,35	90	80	LCE063	43,59
110	100	SETSXE110E	86,71	SETSXE110F	282,12	110	100	LCE063	43,59

Juego de juntas SSE.
 Posiciones 3-9-11.

Set LCE. Set tapón transparente + disco en PVC blanco (10 piezas de cada por set)
 Posiciones 5-6.

d	DN	Ref. muelle INOX A316	€	Ref. muelle INOX recubierto PTFE	€
75	65	ASSE075VX	168,60	ASSE075VOP	209,09
90	80	ASSE090VX	211,54	ASSE090VOP	260,37
110	100	ASSE110VX	277,54	ASSE110VOP	328,47

Tapón + muelle SSE.
 Posiciones 7-12.

d	DN	Ref. PVC-U	€	Ref. C-PVC	€
75	65	SESXE075V	33,15	SESXE075C	95,81
90	80	SESXE090V	41,58	SESXE090C	124,52
110	100	SESXE110V	54,56	SESXE110C	233,78

Casquillo SSE.
 Posición 10.

d	DN	Ref. PVC-U	€	Ref. C-PVC	€
75	65	PRSXE075V	46,08	PRSXE075C	138,36
90	80	PRSXE090V	57,78	PRSXE090C	178,72
110	100	PRSXE110V	75,85	PRSXE110C	335,56

Anillo sujeción SSE.
 Posición 8.

d	DN	Ref. PVC-U	€	Ref. C-PVC	€
75	65	NTVXE075V	80,56	NTVXE075C	88,68
90	80	NTVXE090V	103,10	NTVXE090C	115,33
110	100	NTVXE110V	156,37	NTVXE110C	163,01

Tuerca SSE.
 Posición 1.

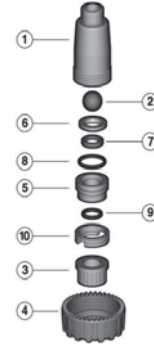

SR

Válvula anti-retorno de bola DN15+50.

d	DN	Ref. EPDM	€	Ref. FKM	€
20	15	SETSR020E	7,13	SETSR020F	21,66
25	20	SETSR025E	7,13	SETSR025F	21,66
32	25	SETSR032E	8,09	SETSR032F	22,79
40	32	SETSR040E	9,40	SETSR040F	37,35
50	40	SETSR050E	16,26	SETSR050F	53,78
63	50	SETSR063E	20,31	SETSR063F	77,30

Juego de juntas SR. Posiciones 7-8-9.

d	DN	Ref. PPH	€	Ref. PVDF	€
20	15	BLSR020M	33,79	BLSR020F	48,45
25	20	BLSR025M	33,79	BLSR025F	55,56
32	25	BLSR032M	41,26	BLSR032F	132,49
40	32	BLSR040M	67,60	BLSR040F	171,37
50	40	BLSR050M	88,28	BLSR050F	302,60
63	50	BLSR063M	122,95	BLSR063F	461,13

Bola SR. Posición 2.

d	DN	Ref. PPH	€	Ref. PVDF	€
20	15	SESR020M	42,22	SESR020F	98,68
25	20	SESR025M	63,79	SESR025F	137,52
32	25	SESR032M	63,79	SESR032F	149,49
40	32	SESR040M	80,52	SESR040F	245,72
50	40	SESR050M	80,52	SESR050F	245,72
63	50	SESR063M	106,46	SESR063F	354,17

Casquillo SR. Posiciones 5-10.

d	DN	Ref. PPH	€	Ref. PVDF	€
20	15	PRSR020M	8,61	PRSR020F	28,03
25	20	PRSR025M	20,47	PRSR025F	34,97
32	25	PRSR032M	20,97	PRSR032F	46,20
40	32	PRSR040M	21,55	PRSR040F	79,73
50	40	PRSR050M	23,72	PRSR050F	99,38
63	50	PRSR063M	29,08	PRSR063F	127,38

Anillo sujeción SR. Posición 6.

d	DN	Ref. PPH	€	Ref. PVDF	€
20	15	NTVKD020M	13,61	NTVKD020F	74,03
25	20	NTVKD025M	25,99	NTVKD025F	78,20
32	25	NTVKD032M	31,32	NTVKD032F	101,47
40	32	NTVKD040M	34,14	NTVKD040F	137,41
50	40	NTVKD050M	40,22	NTVKD050F	160,63
63	50	NTVKD063M	61,48	NTVKD063F	249,87

Tuerca SR. Posición 4..

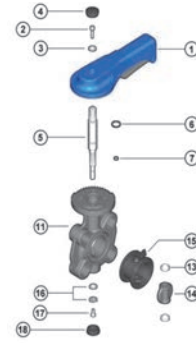

FE

Válvula de mariposa FE DN40+50.

d	DN	Ref. EPDM	€	Ref. FKM	€
50-63	40-50	SETFK063E	8,80	SETFK063F	20,47

Juego de juntas FE.
 Posiciones 6-7-13.

d	DN	Ref. EPDM	€	Ref. FKM	€
50	40	LIN050E	31,83	LIN050F	190,10
63	50	LIN063E	33,60	LIN063F	200,66

Juego primaria FE.
 Posición 15

d	DN	Ref.	€
50-63	40-50	HSFE0S11	44,90

Maneta FE. Con tornillo y tapón de protección.
 Posiciones 1-2-3-4.

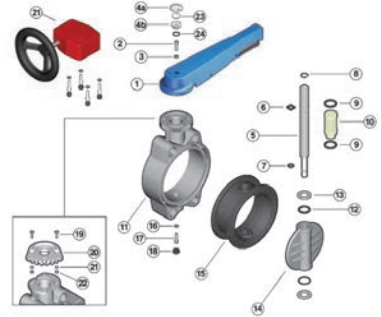

FE

Válvula de mariposa FE DN65+200.

d	DN	Ref. EPDM	€	Ref. FKM	€	d	DN	Ref.	€
75	65	SETFK075E	9,74	SETFK075F	22,79	75	65	STFE075	80,20
90	80	SETFK090E	9,98	SETFK090F	22,79	90	80	STFE090	90,25
110	100	SETFK110E	10,38	SETFK110F	22,79	110	100	STFE110	100,25
140	125	SETFK140E	11,38	SETFK140F	24,30	140	125	STFE140	120,27
160	150	SETFK160E	16,40	SETFK160F	30,43	160	150	STFE160	140,35
225	200	SETFK225E	26,39	SETFK225F	47,14	225	200	STFE225	240,59

Juego de juntas FE.
 Posiciones 6-7-9-12-13.

Eje FE.
 Posición 5.

d	DN	Ref. EPDM	€	Ref. FKM	€	Ref. NBR	€
75	65	LIN075E	35,41	LIN075F	296,16	LIN075N	38,90
90	80	LIN090E	38,99	LIN090F	351,88	LIN090N	42,94
110	100	LIN110E	47,53	LIN110F	507,44	LIN110N	52,26
140	125	LIN140E	64,50	LIN140F	735,69	LIN140N	70,99
160	150	LIN160E	71,52	LIN160F	921,85	LIN160N	78,65
225	200	LIN225E	126,03	LIN225F	1.533,19	LIN225N	138,68

Junta primaria FE.
 Posición 15.

d	DN	Ref. PVC-U	€	d	DN	Ref.	€	d	DN	Ref.	€
75	65	DISCV075	62,25	75	65	HSFE0S11	44,90	75	65	GEAR01	409,67
90	80	DISCV090	73,23	90	80	HSFE0M14	50,08	90	80	GEAR01	409,67
110	100	DISCV110	95,40	110	100	HSFE0M14	50,08	110	100	GEAR01	409,67
140	125	DISCV140	125,16	140	125	HSFE0L17	55,43	140	125	GEAR02	409,67
160	150	DISCV160	160,15	160	150	HSFE0L17	55,43	160	150	GEAR02	409,67
225	200	DISCV225	221,84	225	200	HSFEXL22	98,54	225	200	GEAR03	501,16

Disco FE.
 Posición 14.

Maneta FE.
 Posiciones 1-2-3-4.

Con tornillo y tapón de protección

Kit volante FE.
 Posición 29.

Con tornillos y brida si es necesaria

d	DN	Ref.	€
225	200	UFFE225	54,67

Brida superior con trinquete FE.
 Posiciones 19-20-21-22.

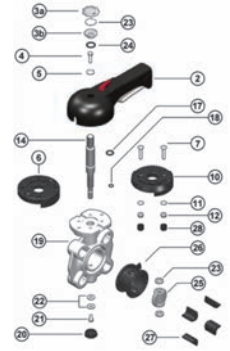

FK

Válvula de mariposa FK DN40+50.

d	DN	Ref. EPDM	€	Ref. FKM	€
50-63	40-50	SETFK063E	8,80	SETFK063F	20,47

Juego de juntas FK.
 Posiciones 17-18-23.

d	DN	Ref.	€
50-63	40-50	HSFKD0S11	58,29

Maneta FK. Con tornillo y tapón de protección
 Posiciones 2-3a-3b-4-5.

d	DN	Ref. EPDM	€	Ref. FKM	€
50	40	LIN050E	31,83	LIN050F	190,10
63	50	LIN063E	33,60	LIN063F	200,66

Juego primaria FK
 Posición 26.

d	DN	Ref. PVC-U	€	Ref. PP-H	€	Ref. PVDF	€	Ref. C-PVC	€
50	40	DISCV050	52,95	DISCM050	64,62	DISCF050	184,76	DISCC050	77,49
63	50	DISCV063	56,04	DISCM063	68,43	DISCF063	195,62	DISCC063	82,08

Disco FK.
 Posición 25.

d	DN	Ref.	€
50-63	40-50	UFFK160	30,19

Brida superior FK.
 Posiciones 7-10-11-12-28.

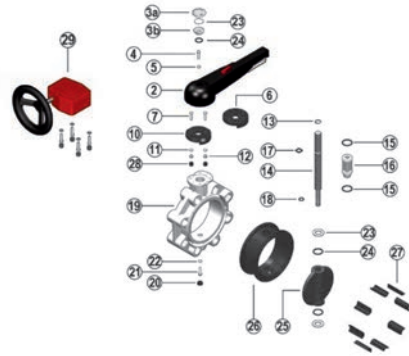

FK

Válvula de mariposa FK DN65+200.

d	DN	Ref. EPDM	€	Ref. FKM	€
75	65	SETFK075E	9,74	SETFK075F	22,79
90	80	SETFK090E	9,98	SETFK090F	22,79
110	100	SETFK110E	10,38	SETFK110F	22,79
140	125	SETFK140E	11,38	SETFK140F	24,30
160	150	SETFK160E	16,40	SETFK160F	30,43
225	200	SETFK225E	26,39	SETFK225F	47,14

Juego de juntas FK. Posiciones 15-17-18-23-24.

d	DN	Ref. PVC-U	€	Ref. PP-H	€	Ref. PVDF	€	Ref. C-PVC	€
75	65	DISCV075	62,25	DISCM075	76,07	DISCF075	217,33	DISCC075	91,14
90	80	DISCV090	73,23	DISCM090	88,19	DISCF090	228,98	DISCC090	106,41
110	100	DISCV110	95,40	DISCM110	104,79	DISCF110	244,92	DISCC110	118,53
140	125	DISCV140	125,16	DISCM140	137,68	DISCF140	319,88	DISCC140	144,12
160	150	DISCV160	160,15	DISCM160	161,05	DISCF160	343,63	DISCC160	169,56
225	200	DISCV225	221,84	DISCM225	244,33	DISCF225	434,56	DISCC225	255,57

Disco FK. Posición 25.

d	DN	Ref.	€
75-110	65-100	GEAR01	409,67
140-160	125-150	GEAR02	409,67
225	200	GEAR03	501,16

Kit volante FK. Posición 29.

Con tornillos y brida si es necesaria

d	DN	Ref.	€
75-160	65-150	UFFK160	30,19
225	200	UFFK225	45,90

Brida superior con trinquete FK.
 Posición 7-10-11-12-28.

d	DN	Ref. EPDM	€	Ref. FKM	€	Ref. NBR	€
75	65	LIN075E	35,41	LIN075F	296,16	LIN075N	38,90
90	80	LIN090E	38,99	LIN090F	351,88	LIN090N	42,94
110	100	LIN110E	47,53	LIN110F	507,44	LIN110N	52,26
140	125	LIN140E	64,50	LIN140F	735,69	LIN140N	70,99
160	150	LIN160E	71,52	LIN160F	921,85	LIN160N	78,65
225	200	LIN225E	126,03	LIN225F	1.533,19	LIN225N	138,68

Junta primaria FK. Posición 26.

d	DN	Ref.	€
75	65	HSFKD0S11	58,29
90-110	80-100	HSFKD0M14	76,96
140-160	125-150	HSFKD0L17	85,10
225	200	HSFKDXL22	125,56

Maneta FK.
 Posición 2-3a-3b-4-5.

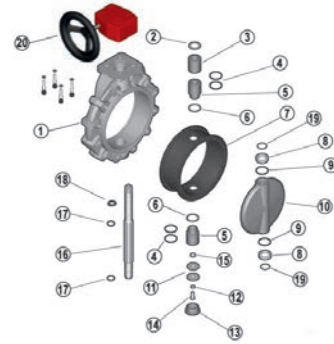

FK

Válvula de mariposa FK DN200-300.

d	DN	Ref. EPDM	€	Ref. FKM	€
280	250	SETFK315E	83,80	SETFK315F	150,01
315	300	SETFK315E	83,80	SETFK315F	150,01

Juego de juntas FK. Posiciones 15-17-18-23-24.

d	DN	Ref. EPDM	€	Ref. FKM	€
280	250	LIN280E	267,58	LIN280F	1.750,53
315	300	LIN315E	374,53	LIN315F	2.145,68

Junta primaria FK. Posición 7.

d	DN	Ref. PVC-U	€	Ref. PP-H	€	Ref. PVDF	€	Ref. C-PVC	€
280	250	DISCV280	428,87	DISCM280	485,18	DISCF280	780,27	DISCC280	515,13
315	300	DISCV315	467,65	DISCM315	530,79	DISCF315	851,76	DISCC315	561,43

Disco FK. Posición 10.

d	DN	Ref.	€
280-315	250-300	GEAR04	585,28

Kit volante FK. Posición 20. Con tornillos y brida si es necesaria

d	DN	Ref.	€
280	250	STFK280 (*)	521,24
315	300	STFK315 (*)	601,42

Eje FK. Posición 16.

(*) Para válvulas con el disco en PVDF usar los códigos STFK280F y STFL315F



FK

Válvula de mariposa FK DN355-400.

d	DN	Ref. EPDM	€	Ref. FKM	€
355-400	350-400	SETFK400E	70,99	SETFK400F	134,93

Juego de juntas FK. Posición 4-6-9-17.

d	DN	Ref. EPDM	€	Ref. FKM	€
355	350	LIN355E	561,25	LIN355F	4.099,53
400	400	LIN400E	652,02	LIN400F	5.760,47

Junta primaria FK. Posición 7.

d	DN	Ref. PVC-U	€	Ref. PP-H	€	Ref. PVDF	€
355	350	DISCV355	825,32	DISCM355	924,36	DISCF355	4.447,14
400	400	DISCV400	924,36	DISCM400	1.072,92	DISCF400	5.407,55

Disco FK. Posición 10.

d	DN	Ref.	€
355-400	350-400	GEAR05	1.019,04

Volante FK. Posición 20.

d	DN	Ref.	€
355	350	STFK355 (*)	724,22
400	400	STFK400 (*)	812,55

Eje FK. Posición 16.

(*) Sólo para válvulas con el disco en PVDF-U. Para otros materiales consultar

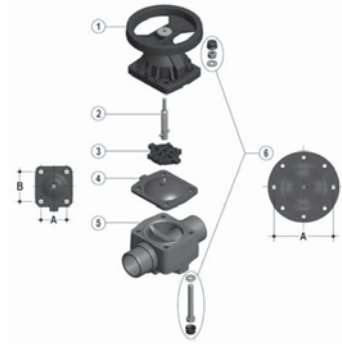

VM

Válvula de membrana VM.

d	DN	Ref. EPDM	€	Ref. FKM	€	Ref. PTFE	€	Ref. NBR	€
90	80	DIA090E	145,52	DIA090F	701,04	DIA090P	632,20	DIA090N	145,52
110	100	DIA110E	294,19	DIA110F	1.333,24	DIA110P	932,60	DIA110N	294,19

Membrana VM. Posición 4.

d	DN	Ref. PVC-U (EPDM / FKM)	€	Ref. PP-H (EPDM / FKM)	€	Ref. PVDF (EPDM / FKM)	€	Ref. C-PVC (EPDM / FKM)	€
90	80	SPBDVM090DV	266,11	SPBDVM090DM	332,64	SPBDVM090DF	1.585,62	SPBDVM090DC	521,10
110	100	SPBDVM110DV	354,79	SPBDVM110DM	376,98	SPBDVM110DF	2.306,27	SPBDVM110DC	671,90

d	DN	Ref. PVC-U (PTFE)	€	Ref. PP-H (PTFE)	€	Ref. PVDF (PTFE)	€	Ref. C-PVC (PTFE)	€
90	80	SPBDVMP090DV	294,95	SPBDVMP090DM	365,89	SPBDVMP090DF	1.628,77	SPBDVMP090DC	549,94
110	100	SPBDVMP110DV	388,09	SPBDVMP110DM	410,26	SPBDVMP110DF	2.349,48	SPBDVMP110DC	700,74

Cuerpo M-M VMD... Posición 5.

d	DN	Ref.	€
90	80	COVMMN075090	144,15
110	100	COVMMN110	155,24

Compresor VM. Posición 3.

d	DN	Ref.	€
90	80	ATVMMN075090	609,84
110	100	ATVMMN110	820,52

Volante DK. Posiciones 1-2-6.

d	DN	Ref.	€
90	80	BSVMMN75090X	126,37
110	100	BSVMMN110X	188,99

Cierres VM. Posiciones 10-11-12.

Kit cierre DK compuesto por tornillos, tuercas y tapones protectores

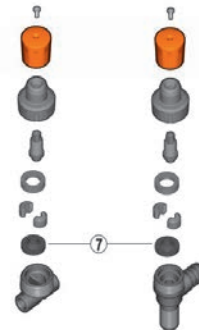

VM-RM

Grifo de membrana VM-RM.

d - Rh	DN	Ref.	€
12 - 1/4"	8	DIARM020E	12,09
20 - 1/2"	15	DIARM020E	12,09

Cierres VM. Posiciones 10-11-12.

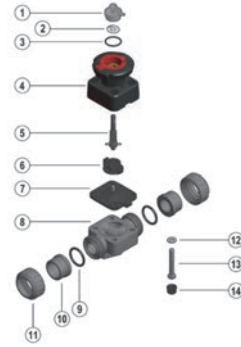

DK

Válvula de membrana DK.

d	DN	Ref. EPDM	€	Ref. FKM	€	Ref. PTFE	€	Ref. NBR	€
20	15	DIA025E	32,93	DIA025F	107,36	DIADK025P	127,59	DIA025N	32,93
25	20	DIA025E	32,93	DIA025F	107,36	DIADK025P	127,59	DIA025N	32,93
32	25	DIA032E	34,38	DIA032F	118,87	DIADK032P	145,52	DIA032N	34,38
40	32	DIA032E	34,38	DIA032F	118,87	DIADK032P	145,52	DIA032N	34,38
50	40	DIA050E	42,23	DIA050F	201,85	DIADK050P	240,99	DIA050N	42,23
63	50	DIA063E	62,61	DIA063F	287,98	DIADK063P	295,66	DIA063N	62,61
75	65	DIA063E	62,61	DIA063F	287,98	DIADK063P	295,66	DIA063N	62,61

Membrana DK.

Posición 7.

d	DN	Ref. PVC-U	€	Ref. PP-H	€	Ref. PVDF	€	Ref. C-PVC	€
20	15	SPBDDK020DV	38,77	SPBDDK020DM	52,56	SPBDDK020DF	155,11	SPBDDK020DC	56,97
25	20	SPBDDK025DV	41,78	SPBDDK025DM	58,47	SPBDDK025DF	166,67	SPBDDK025DC	65,77
32	25	SPBDDK032DV	56,12	SPBDDK032DM	82,53	SPBDDK032DF	205,21	SPBDDK032DC	89,80
40	32	SPBDDK040DV	60,01	SPBDDK040DM	83,06	SPBDDK040DF	300,12	SPBDDK040DC	103,58
50	40	SPBDDK050DV	73,66	SPBDDK050DM	140,37	SPBDDK050DF	367,34	SPBDDK050DC	135,08
63	50	SPBDDK063DV	96,67	SPBDDK063DM	168,39	SPBDDK063DF	494,50	SPBDDK063DC	140,61
75	65	SPBDDK075DV	135,30	SPBDDK075DM	235,74	SPBDDK075DF	692,29	SPBDDK075DC	196,86

Cuerpo M-M DKD...

Posición 8.

Cuerpo DK con spigots para encolar macho serie métrica

d	DN	Ref. PVC-U	€	Ref. PP-H	€	Ref. PVDF	€	Ref. C-PVC	€
20	15	UNBDDK020V	41,15	UNBDDK020M	91,72	UNBDDK020F	164,51	UNBDDK020C	98,85
25	20	UNBDDK025V	45,96	UNBDDK025M	98,46	UNBDDK025F	183,42	UNBDDK025C	111,85
32	25	UNBDDK032V	62,30	UNBDDK032M	124,60	UNBDDK032F	227,78	UNBDDK032C	151,36
40	32	UNBDDK040V	69,40	UNBDDK040M	138,86	UNBDDK040F	335,68	UNBDDK040C	175,39
50	40	UNBDDK050V	93,07	UNBDDK050M	177,26	UNBDDK050F	385,96	UNBDDK050C	221,58
63	50	UNBDDK063V	118,92	UNBDDK063M	219,61	UNBDDK063F	522,79	UNBDDK063C	265,32

Cuerpo con enlace DKU...

Posición 8.

Cuerpo DK con enlaces para encolar hembra

Continúa en la página siguiente...

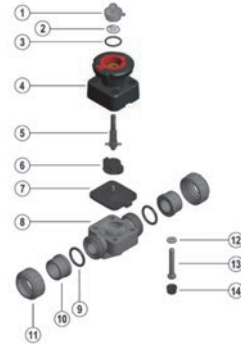

DK

Válvula de membrana DK.

d	DN	Ref. PVC-U	€	Ref. PP-H	€	Ref. PVDF	€	Ref. C-PVC	€
20	15	FLBDDK020OV	102,81	FLBDDK020OM	144,81	FLBDDK020OF	356,62	FLBDDK020OC	173,75
25	20	FLBDDK025OV	116,24	FLBDDK025OM	158,47	FLBDDK025OF	373,76	FLBDDK025OC	203,55
32	25	FLBDDK032OV	145,68	FLBDDK032OM	201,27	FLBDDK032OF	432,82	FLBDDK032OC	241,63
40	32	FLBDDK040OV	180,33	FLBDDK040OM	244,58	FLBDDK040OF	686,64	FLBDDK040OC	296,56
50	40	FLBDDK050OV	227,36	FLBDDK050OM	305,12	FLBDDK050OF	769,60	FLBDDK050OC	358,29
63	50	FLBDDK063OV	282,78	FLBDDK063OM	383,48	FLBDDK063OF	990,67	FLBDDK063OV	282,78

Cuerpo con bridas DKO...
 Posición 8.

Cuerpo DK con bridas PN10/16 FF EN 558-1
 Disponible también con bridas ANSI 150 lbs. al mismo precio

d	DN	Ref.	€
20 ÷ 25	15 ÷ 20	CODK020025	20,55
32 ÷ 40	25 ÷ 32	CODK032040	22,47
50	40	COVMMN040050	28,69
63 ÷ 75	50 ÷ 65	COVMMN063	37,21

Compresor DK.
 Posición 6.

d	DN	Ref.	€
20 ÷ 25	15 ÷ 20	ATDKMN020025	78,52
32 ÷ 40	25 ÷ 32	ATDKMN032040	113,08
50	40	ATDKMN050	155,68
63 ÷ 75	50 ÷ 65	ATDKMN063075	190,18

Volante DK.
 Posiciones 1-2-3-4-5-6.

d	DN	Ref.	€
20 ÷ 40	15 ÷ 32	TCSDKMN02004	22,42
50	40	TCSDKMN050	28,39
63 ÷ 75	50 ÷ 65	TCSDKMN06307	32,43

Tapón transparente DK.
 Posiciones 1-2-3.

d	DN	Ref.	€
20 ÷ 25	15 ÷ 20	BSDK020025X	27,34
32 ÷ 40	25 ÷ 32	BSVM020032X	37,69
50	40	BSVM040050X	44,34
63 ÷ 75	50 ÷ 65	BSVM063X	55,54

Kit cierre DK.
 Posiciones 12-13-14.

Compuesto por tornillos,
 tuercas y tapones protectores

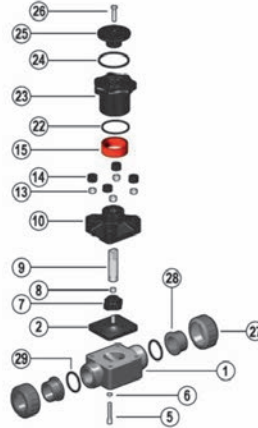

CM

Válvula de membrana compacta CM.

d	DN	Ref. EPDM	€	Ref. FKM	€	Ref. PTFE	€
16 - 20	10 - 15	DIACM020E	28,18	DIACM020F	92,33	DIACM020Q*	84,51

Membrana CM.

Posición 2.

* Para válvulas suministradas antes de enero 2019 por favor solicitar la membrana en PTFE con el código DIACM020P.

d	DN	Ref. PVC-U (EPDM / FKM)	€	Ref. PP-H (EPDM / FKM)	€	Ref. PVDF (EPDM / FKM)	€	Ref. C-PVC (EPDM / FKM)	€
16 - 20	10 - 15	SPBDCM020DV	28,31	SSPBDCM020DM	34,27	SPBDCM020DF	135,15	SPBDCM020DC	94,49

d	DN	Ref. PVC-U (PTFE)	€	Ref. PP-H (PTFE)	€	Ref. PVDF (PTFE)	€	Ref. C-PVC (PTFE)	€
16 - 20	10 - 15	SPBDCMQ020DV	42,85	SPBDCMQ020DM	51,40	SPBDCMQ020DF	144,83	SPBDCMQ020DC	102,85

Cuerpo M-M CMD...

Posición 1.

Cuerpo CM con spigots para membranas EPDM / FKM o PTFE

d	DN	Ref. PVC-U (EPDM / FKM)	€	Ref. PP-H (EPDM / FKM)	€	Ref. PVDF (EPDM / FKM)	€	Ref. C-PVC (EPDM / FKM)	€
16 - 20	10 - 15	UNBDCM020V	56,68	UNBDCM020M	66,11	UNBDCM020F	171,96	UNBDCM020C	123,13

d	DN	Ref. PVC-U (PTFE)	€	Ref. PP-H (PTFE)	€	Ref. PVDF (PTFE)	€	Ref. C-PVC (PTFE)	€
16 - 20	10 - 15	UNBDCMQ020V	68,56	UNBDCMQ020M	77,17	UNBDCMQ020F	178,25	UNBDCMQ020C	128,78

Cuerpo con enlace CMU...

Posición 1.

Cuerpo CM con enlaces para membranas EPDM / FKM o PTFE

Continúa en la página siguiente...

d	DN	Ref. PVC-U (EPDM / FKM)	€	Ref. PP-H (EPDM / FKM)	€	Ref. PVDF (EPDM / FKM)	€
16	10	SKBDCM016IV	43,97	SKBDCM016IM	62,09	SKBDCM016IF	135,15
20	15	SKBDCM020IV	43,97	SKBDCM020IM	62,09	SKBDCM020IF	135,15

d	DN	Ref. PVC-U (PTFE)	€	Ref. PP-H (PTFE)	€	Ref. PVDF (FKM)	€
16	10	SKBDCMQ016IV	57,01	SKBDCMQ016IM	74,42	SKBDCMQ016IF	144,83
20	15	SKBDCMQ020IV	57,01	SKBDCMQ020IM	74,42	SKBDCMQ020IF	144,83

Cuerpo H-H CMI...
 Posición 1.

Cuerpo CM H-H para membranas EPDM / FKM o PTFE

Rh	DN	Ref. PVC-U (EPDM / FKM)	€	Ref. PP-H (EPDM / FKM)	€	Ref. PVDF (EPDM / FKM)	€
3/8"	10	TRBDCM038FV	43,97	TRBDCM038FM	62,09	TRBDCM038FF	135,15
1/2"	15	TRBDCM012FV	43,97	TRBDCM012FM	62,09	TRBDCM012FF	135,15

Rh	DN	Ref. PVC-U (PTFE)	€	Ref. PP-H (PTFE)	€	Ref. PVDF (FKM)	€
3/8"	10	TRBDCMQ038FV	57,01	TRBDCMQ038FM	74,42	TRBDCMQ038FF	144,83
1/2"	15	TRBDCMQ012FV	57,01	TRBDCMQ012FM	74,42	TRBDCMQ012FF	144,83

Cuerpo H-H roscado CMF...
 Posición 1.

Cuerpo CM H-H roscado para membranas EPDM / FKM o PTFE

d	DN	Ref. PVC-U	€	Ref. PP-H	€	Ref. PVDF	€	Ref. C-PVC	€
20	15	EFV100	1,25	EFM020	7,79	EFF020	31,74	EFC100	6,80

Tuercas CM.
 Posición 27.

Tuercas para cuerpo CM con enlaces

d	DN	Ref.	€
16 - 20	10 -15	ATCMMN	112,27

Volante CM.
 Posiciones 7-26.

d	DN	Ref.	€
16 - 20	10 -15	BSCMX	22,90

Kit Cierre CM.
 Posiciones 5-6.

Compuesto por tornillos, tuercas y tapones protectores



6,80

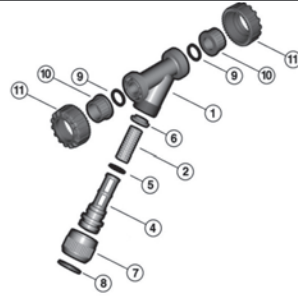

RV

Filtro inclinado RV DN10+50.

d	DN	Ref. EPDM	€	Ref. FKM	€
16-20	10-15	SETRV020E	3,85	SETRV020F	31,29
25	20	SETRV025E	5,79	SETRV025F	42,23
32	25	SETRV032E	5,79	SETRV032F	42,23
40	32	SETRV040E	9,27	SETRV040F	67,24
50	40	SETRV050E	9,27	SETRV050F	67,24
63	50	SETRV063E	13,29	SETRV063F	96,97

Juego de juntas RV. Posiciones 5-9.

d	DN	Ref. PVC-U luz 0,3 mm.	€	Ref. PVC-U luz 0,5 mm. *	€	Ref. PVC-U luz 0,7 mm.	€	Ref. PVC-U luz 0,9 mm.	€
16-20	10-15	SCR10V020	7,87	SCR15V020	7,87	SCR20V020	7,87	SCR25V020	7,87
25	20	SCR10V025	8,63	SCR15V025	8,63	SCR20V025	5,37	SCR25V025	8,63
32	25	SCR10V032	9,05	SCR15V032	9,05	SCR20V032	9,05	SCR25V032	9,05
40	32	SCR10V040	11,04	SCR15V040	11,04	SCR20V040	11,04	SCR25V040	11,04
50	40	SCR10V050	11,04	SCR15V050	11,04	SCR20V050	11,04	SCR25V050	11,04
63	50	SCR10V063	13,02	SCR15V063	13,02	SCR20V063	13,02	SCR25V063	13,02

* Estándar en los filtros de PVC-U

d	DN	Ref. PP luz 0,5 mm. **	€	Ref. Inox luz 0,3 mm.	€
16-20	10-15	SCR15M020	10,62	SCR07X020	9,64
25	20	SCR15M025	11,36	SCR07X025	10,30
32	25	SCR15M032	12,28	SCR07X032	11,04
40	32	SCR15M040	13,92	SCR07X040	13,02
50	40	SCR15M050	15,50	SCR07X050	13,29
63	50	SCR15M063	18,81	SCR07X063	15,72

Mallas RV. Posición 2.

** Estándar en los filtros de PP y C-PVC

d	DN	Ref. PVC-U	€	Ref. PVC transparente	€
16	10	SPBDRV016DV	23,69	SPBDRV016DT	28,10
20	15	SPBDRV020DV	25,88	SPBDRV020DT	28,10
25	20	SPBDRV025DV	32,08	SPBDRV025DT	34,44
32	25	SPBDRV032DV	34,44	SPBDRV032DT	34,44
40	32	SPBDRV040DV	50,37	SPBDRV040DT	50,37
50	40	SPBDRV050DV	70,49	SPBDRV050DT	70,49
63	50	SPBDRV063DV	104,08	SPBDRV063DT	115,44

Cuerpo M-M RVD. Posición 1.

Continúa en la página siguiente...

d	DN	Ref. PVC-U	€	Ref. PVC transparente	€	Ref. PP-H	€	Ref. C-PVC	€
16-20	10-15	UNBDRV020V	25,88	UNBDRV020T	28,10	UNBDRV020M	62,09	UNBDRV020C	84,24
25	20	UNBDRV025V	32,08	UNBDRV025T	34,44	UNBDRV025M	66,53	UNBDRV025C	93,15
32	25	UNBDRV032V	34,44	UNBDRV032T	34,44	UNBDRV032M	70,97	UNBDRV032C	99,81
40	32	UNBDRV040V	50,37	UNBDRV040T	50,37	UNBDRV040M	75,38	UNBDRV040C	128,65
50	40	UNBDRV050V	70,49	UNBDRV050T	70,49	UNBDRV050M	108,62	UNBDRV050C	184,05
63	50	UNBDRV063V	104,08	UNBDRV063T	115,44	UNBDRV063M	126,37	UNBDRV063C	187,24

Cuerpo con enlaces RVU... Posición 1.

d	DN	Ref.	€
16-20	10-15	SRRV020V	6,94
25	20	SRRV025V	10,33
32	25	SRRV032V	12,92
40	32	SRRV040V	15,95
50	40	SRRV050V	19,54
63	50	SRRV063V	23,13

Anillo cierre RV. Posición 8.

d	DN	Ref. PVC-U	€	Ref. PP-H	€	Ref. C-PVC	€
16-20	10-15	SURV020V	19,33	SURV020M	52,95	SURV020C	51,03
25	20	SURV025V	27,34	SURV025M	63,41	SURV025C	66,53
32	25	SURV032V	31,17	SURV032M	74,80	SURV032C	79,81
40	32	SURV040V	32,08	SURV040M	77,62	SURV040C	77,62
50	40	SURV050V	55,72	SURV050M	82,06	SURV050C	93,15
63	50	SURV063V	65,92	SURV063M	88,68	SURV063C	113,08

Soporte malla RV. Posición 4.

d	DN	Ref. PVC-U	€	Ref. PP-H	€	Ref. C-PVC	€
16-20	10-15	NTVKD020V	10,22	NTVKD020M	13,61	NTVKD020C	19,54
25	20	NTVKD025V	19,33	NTVKD025M	25,99	NTVKD025C	35,78
32	25	NTVKD032V	23,37	NTVKD032M	31,32	NTVKD032C	43,92
40	32	NTVKD040V	25,09	NTVKD040M	34,14	NTVKD040C	48,78
50	40	NTVKD050V	29,68	NTVKD050M	40,22	NTVKD050C	56,94
63	50	NTVKD063V	44,95	NTVKD063M	61,48	NTVKD063C	87,79

Tuerca unión RV. Posición 11.

d	DN	Ref. PVC-U	€	Ref. PP-H	€	Ref. C-PVC	€
16-20	10-15	RRRV020V	10,03	RRRV020M	15,50	RRRV020C	22,19
25	20	RRRV025V	13,81	RRRV025M	19,54	RRRV025C	25,51
32	25	RRRV032V	16,72	RRRV032M	22,79	RRRV032C	26,59
40	32	RRRV040V	21,90	RRRV040M	26,86	RRRV040C	28,81
50	40	RRRV050V	32,03	RRRV050M	30,90	RRRV050C	37,69
63	50	RRRV063V	39,04	RRRV063M	42,26	RRRV063C	46,57

Anillo sujeción RV. Posición 6.

d	DN	Ref. PVC-U	€	Ref. PP-H	€	Ref. C-PVC	€
16-20	10-15	BNRV020V	26,07	BNRV020M	49,41	BNRV020C	57,65
25	20	BNRV025V	31,29	BNRV025M	66,48	BNRV025C	75,38
32	25	BNRV032V	36,10	BNRV032M	89,53	BNRV032C	93,15
40	32	BNRV040V	41,54	BNRV040M	97,90	BNRV040C	104,22
50	40	BNRV050V	48,63	BNRV050M	99,81	BNRV050C	110,90
63	50	BNRV063V	54,49	BNRV063M	101,97	BNRV063C	115,33

Tuerca cierre RV. Posición 7.

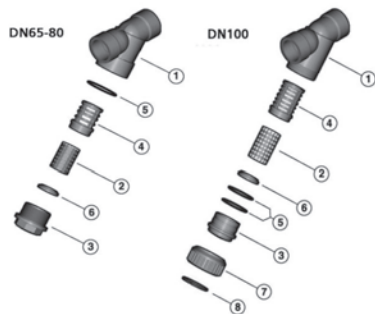

RV

Filtro inclinado RV DN65+100.

d	DN	Ref. EPDM	€	Ref. FKM	€
75	65	SETRV075E	17,27	SETRV075F	125,19
90	80	SETRV090E	30,77	SETRV090F	223,73
110	100	SETRV110E	38,38	SETRV110F	277,04

Juego de juntas RV. Posición 5.

d	DN	Ref. PVC-U luz 0,3 mm.	€	Ref. PVC-U luz 0,5 mm. *	€	Ref. PVC-U luz 0,7 mm.	€	Ref. PVC-U luz 0,9 mm.	€
75	65	SCR10V075	26,39	SCR15V075	26,39	SCR20V075	26,39	SCR25V075	26,39
90	80	SCR10V090	32,86	SCR15V090	32,86	SCR20V090	32,86	SCR25V090	32,86
110	100	SCR10V110	48,78	SCR15V110	48,78	SCR20V110	48,78	SCR25V110	48,78

* Estándar en los filtros de PVC-U

d	DN	Ref. PP luz 0,5 mm. **	€	Ref. Inox luz 0,3 mm.	€
75	65	SCR15M075	25,09	SCR07X075	51,84
90	80	SCR15M090	31,78	SCR07X090	60,40
110	100	SCR15M110	46,40	SCR07X110	86,15

Mallas RV. Posición 2.

** Estándar en los filtros de PP y C-PVC

d	DN	Ref. PVC-U	€	Ref. PVC transparente	€	Ref. PP-H	€
75	65	SKBDRV075IV	189,67	SKBDRV075IT	256,20	SKBDRV075IM	425,76
90	80	SKBDRV090IV	246,59	SKBDRV090IT	371,80	SKBDRV090IM	624,47
110	100	SKBDRV110IV	418,97	SKBDRV110IT	569,20	SKBDRV110IM	830,84

Cuerpo H-H encolar RVI... Posición 1.

Rh	DN	Ref. PVC-U	€	Ref. PVC transparente	€
2½"	65	TRBDRV212FV	189,67	TRBDRV212FT	256,20
3"	80	TRBDRV300FV	246,59	TRBDRV300FT	371,80
4"	100	TRBDRV400FV	418,97	TRBDRV400FT	569,20

Cuerpo H-H roscar RVI... Posición 1.

** Estándar en los filtros de PP y C-PVC

d	DN	Ref. PVC-U	€	Ref. PP-H	€
110	100	BNRV110V	158,06	BNRV110M	224,54

Tuerca cierre RV. Posición 7.

d	DN	Ref.	€
110	100	SRRV110V	40,22

Anillo cierre RV. Posición 8.

d	DN	Ref. PVC-U	€	Ref. PP-H	€
75	65	RRRV075V	71,54	RRRV075M	53,64
90	80	RRRV090V	74,92	RRRV090M	68,27
110	100	RRRV110V	94,91	RRRV110M	134,24

Anillo sujeción RV. Posición 6.

Continúa en la página siguiente...

d	DN	Ref. PVC-U	€	Ref. PP-H	€
75	65	BORV075V	81,29	BORV075M	147,85
90	80	BORV090V	96,08	BORV090M	177,40
110	100	BORV110V	155,24	BORV110M	325,26

Tapón RV. Posición 3.

d	DN	Ref. PVC-U	€	Ref. PP-H	€
75	65	SURV075V	58,56	SURV075M	71,57
90	80	SURV090V	74,80	SURV090M	74,80
110	100	SURV110V	79,70	SURV110M	94,91

Soporte malla RV. Posición 4.

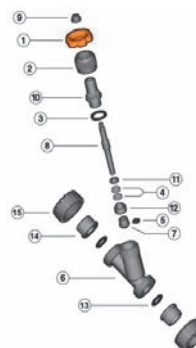

VV

Válvula de asiento inclinado VV DN10=50.

d	DN	Ref. EPDM / PTFE	€	Ref. FKM / PTFE	€	d	DN	Ref.	€
16-20	10-15	SETVV020EP	6,55	SETVV020FP	31,80	16-20	10-15	HWVV020	10,62
25	20	SETVV025EP	8,09	SETVV025FP	37,61	25	20	HWVV025	11,57
32	25	SETVV032EP	12,49	SETVV032FP	45,22	32	25	HWVV032	18,49
40	32	SETVV040EP	16,61	SETVV040FP	65,47	40	32	HWVV040	22,42
50	40	SETVV050EP	16,61	SETVV050FP	72,89	50	40	HWVV050	28,81
63	50	SETVV063EP	16,61	SETVV063FP	102,92	63	50	HWVV063	33,28

Juego de juntas VV. Posiciones 3-4-13.

Volante VV. Posiciones 1-9.

d	DN	Ref.	€	d	DN	Ref. PVC-U	€	Ref. PVC-U / EPDM	€	Ref. PVC-U / EPDM	€
16	10	SPBDRV016DV	23,69	16	10	UNBDRV020V	25,88	ASVV020VE	36,06	ASVV020VF	36,06
20	15	SPBDRV020DV	25,88	20	15	UNBDRV020V	25,88	ASVV020VE	36,06	ASVV020VF	36,06
25	20	SPBDRV025DV	32,08	25	20	UNBDRV025V	32,08	ASVV025VE	43,48	ASVV025VF	43,48
32	25	SPBDRV032DV	34,44	32	25	UNBDRV032V	34,44	ASVV032VE	50,66	ASVV032VF	50,66
40	32	SPBDRV040DV	50,37	40	32	UNBDRV040V	50,37	ASVV040VE	77,56	ASVV040VF	77,56
50	40	SPBDRV050DV	70,49	50	40	UNBDRV050V	70,49	ASVV050VE	98,11	ASVV050VF	98,11
63	50	SPBDRV063DV	104,08	63	50	UNBDRV063V	104,08	ASVV063VE	126,95	ASVV063VF	126,95

Cuerpo M-M VVD... Posición 6.

Cuerpo con enlaces VVU. Posición 6.

Eje VV. Posiciones 5-7-8-10-11-12.

d	DN	Ref. PVC-U	€
16-20	10-15	NTVKD020V	10,22
25	20	NTVKD025V	19,33
32	25	NTVKD032V	23,37
40	32	NTVKD040V	25,09
50	40	NTVKD050V	29,68
63	50	NTVKD063V	44,95

Tuerca unión VV. Posición 15.

d	DN	Ref. PVC-U	€
16-20	10-15	BNRV020V	26,07
25	20	BNRV025V	31,29
32	25	BNRV032V	36,10
40	32	BNRV040V	41,54
50	40	BNRV050V	48,63
63	50	BNRV063V	54,49

Tuerca cierre VV. Posición 2.

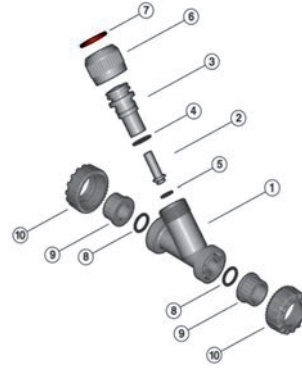

VR

Válvula anti retorno inclinada VR DN10÷50.

d	DN	Ref. EPDM	€	Ref. FKM	€
16-20	10-15	SETVR020E	1,93	SETVR020F	15,72
25	20	SETVR025E	2,43	SETVR025F	18,91
32	25	SETVR032E	3,33	SETVR032F	26,78
40	32	SETVR040E	4,65	SETVR040F	44,68
50	40	SETVR050E	5,15	SETVR050F	62,61
63	50	SETVR063E	5,68	SETVR063F	98,54

Juego de juntas VR.
 Posiciones 4-5-6.

d	DN	Ref. PVC-U	€
16	10	SPBDRV016DV	23,69
20	15	SPBDRV020DV	25,88
25	20	SPBDRV025DV	32,08
32	25	SPBDRV032DV	34,44
40	32	SPBDRV040DV	50,37
50	40	SPBDRV050DV	70,49
63	50	SPBDRV063DV	104,08

Cuerpo M-M VRDV.
 Posición 1.

d	DN	Ref.	€
16	10	SRRV020V	6,94
20	15	SRRV020V	6,94
25	20	SRRV025V	10,33
32	25	SRRV032V	12,92
40	32	SRRV040V	15,95
50	40	SRRV050V	19,54
63	50	SRRV063V	23,13

Anillo cierre VR.
 Posición 7.

d	DN	Ref. PVC-U	€	Ref. PP-H	€
16-20	10-15	UNBDRV020V	25,88	UNBDRV020M	62,09
25	20	UNBDRV025V	32,08	UNBDRV025M	66,53
32	25	UNBDRV032V	34,44	UNBDRV032M	70,97
40	32	UNBDRV040V	50,37	UNBDRV040M	75,38
50	40	UNBDRV050V	70,49	UNBDRV050M	108,62
63	50	UNBDRV063V	104,08	UNBDRV063M	126,37

Cuerpo con enlaces VRU...
 Posición 1.

Continúa en la página siguiente...

d	DN	Ref. PVC-U	€	Ref. PP-H	€
16-20	10-15	BOVR020V	27,76	BOVR020M	52,48
25	20	BOVR025V	28,97	BOVR025M	61,48
32	25	BOVR032V	31,46	BOVR032M	78,04
40	32	BOVR040V	44,16	BOVR040M	104,08
50	40	BOVR050V	57,18	BOVR050M	109,87
63	50	BOVR063V	85,10	BOVR063M	117,98

Porta pistón VR.
Posición 3.

d	DN	Ref. PVC-U	€	Ref. PP-H	€
16-20	10-15	NTVKD020V	10,22	NTVKD020M	13,61
25	20	NTVKD025V	19,33	NTVKD025M	25,99
32	25	NTVKD032V	23,37	NTVKD032M	31,32
40	32	NTVKD040V	25,09	NTVKD040M	34,14
50	40	NTVKD050V	29,68	NTVKD050M	40,22
63	50	NTVKD063V	44,95	NTVKD063M	61,48

Tuerca unión VR.
Posición 10.

d	DN	Ref. PVC-U	€	Ref. PP-H	€
16-20	10-15	BNRV020V	26,07	BNRV020M	49,41
25	20	BNRV025V	31,29	BNRV025M	66,48
32	25	BNRV032V	36,10	BNRV032M	89,53
40	32	BNRV040V	41,54	BNRV040M	97,90
50	40	BNRV050V	48,63	BNRV050M	99,81
63	50	BNRV063V	54,49	BNRV063M	101,97

Tuerca cierre VR.
Posición 6.

d	DN	Ref. PVC-U / EPDM	€	Ref. PVC-U / FKM	€	Ref. PP-H / EPDM	€	Ref. PP-H / FKM	€
16-20	10-15	PSVR020VE	24,59	PSVR020VF	24,59	PSVR020ME	24,59	PSVR020MF	24,59
25	20	PSVR025VE	29,29	PSVR025VF	29,29	PSVR025ME	29,29	PSVR025MF	29,29
32	25	PSVR032VE	31,78	PSVR032VF	34,02	PSVR032ME	31,78	PSVR032MF	36,20
40	32	PSVR040VE	37,53	PSVR040VF	41,96	PSVR040ME	37,53	PSVR040MF	46,40
50	40	PSVR050VE	47,04	PSVR050VF	51,69	PSVR050ME	47,04	PSVR050MF	55,89
63	50	PSVR063VE	65,63	PSVR063VF	71,73	PSVR063ME	65,63	PSVR063MF	74,53

Pistón VR.
Posiciones 2-5

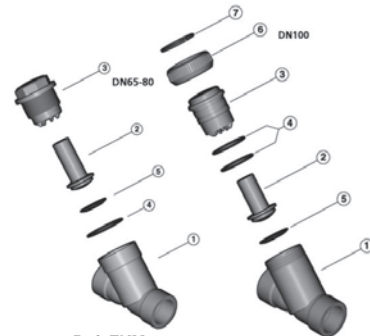

VR

Válvula anti retorno inclinada VR DN65+100

d	DN	Ref. EPDM	€	Ref. FKM	€
75	65	SETVR075E	19,20	SETVR075F	161,21
90	80	SETVR090E	22,79	SETVR090F	203,49
110	100	SETVR110E	40,70	SETVR110F	219,10

Juego de juntas VR.
Posiciones 4-5.

d	DN	Ref. PVC-U	€	Ref. PP-H	€
75	65	BOVR075V	184,05	BOVR075M	206,53
90	80	BOVR090V	239,38	BOVR090M	340,03
110	100	BOVR110V	347,99		

Porta pistón VR.
Posición 3

d	DN	Ref. PVC-U	€	Ref. PP-H	€	Rh	DN	Ref. PVC-U	€
75	65	SKBDVR075IV	189,67	SKBDVR075IM	425,76	2½"	65	TRBDVR212FV	189,67
90	80	SKBDVR090IV	246,59	SKBDVR090IM	624,47	3"	80	TRBDVR300FV	246,59
110	100	SKBDVR110IV	418,97			4"	100	TRBDVR400FV	418,97

Cuerpo H-H encolar VRI...
Posición 1.

Cuerpo H-H roscar VRFV...
Posición 1.

d	DN	Ref. PVC-U / EPDM	€	Ref. PVC-U / FKM	€	Ref. PP-H / EPDM	€	Ref. PP-H / FKM	€
75	65	PSVR075VE	154,63	PSVR075VF	188,12	PSVR075ME	203,65	PSVR075MF	247,17
90	80	PSVR090VE	169,95	PSVR090VF	285,04	PSVR090ME	282,98	PSVR090MF	406,53
110	100	PSVR110VE	226,94	PSVR110VF	380,60				

Pistón VR.
Posición 2-5.

d	DN	Ref.	€
110	100	SRRV110V	40,22

Anillo cierre VR.
Posición 7.

d	DN	Ref. PVC-U	€
110	100	BNRV110V	158,06

Tuerca cierre VR.
Posición 6.

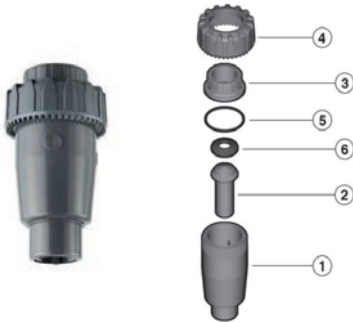

VA

Válvula de purgabola / ventosa VA.

d	DN	Ref. EPDM	€
16-20	10-15	SETVZA020E	2,43
25	20	SETVZA025E	3,33
32	25	SETVZA032E	4,39
40	32	SETVZA040E	6,82
50	40	SETVZA050E	14,05
63	50	SETVZA063E	16,61

Juego de juntas VA-VZ.
Posiciones 5-6.

d	DN	Ref. PVC-U / EPDM	€
16-20	10-15	PSVA020VE	23,37
25	20	PSVA025VE	25,75
32	25	PSVA032VE	27,94
40	32	PSVA040VE	33,86
50	40	PSVA050VE	42,42
63	50	PSVA063VE	59,29

Pistón VA.
Posiciones 2-6.



VZ

Válvula de fondo / pie VZ.

d	DN	Ref. PVC-U	€
16-20	10-15	NTVKD020V	10,22
25	20	NTVKD025V	19,33
32	25	NTVKD032V	23,37
40	32	NTVKD040V	25,09
50	40	NTVKD050V	29,68
63	50	NTVKD063V	44,95

Tuerca unión VA-VZ.
Posición 4.

d	DN	Ref. PVC-U / EPDM	€
16-20	10-15	PSVR020VE	24,59
25	20	PSVR025VE	29,29
32	25	PSVR032VE	31,78
40	32	PSVR040VE	37,53
50	40	PSVR050VE	47,04
63	50	PSVR063VE	65,63

Pistón VZ.
Posiciones 2-6.

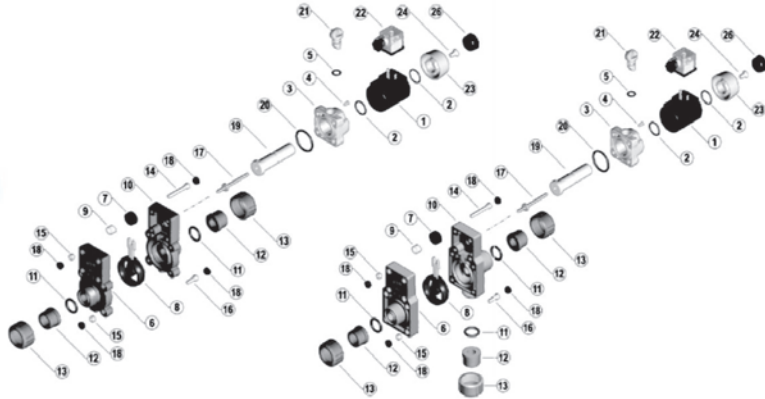

S1/S2

Válvulas de solenoide S1 y S2.

Voltaje	Ref. para válvula S1	€	Ref. para válvula S2	€
24 V DC	SLS1024VDC	126,27	SLS2024VDC	197,98
24 V AC	SLS1024VAC	126,27	SLS2024VAC	197,98
230 V AC	SLS1230VAC	126,27	SLS2230VAC	197,98

Solenoide.

Posición 1.

Voltaje	Ref.	€
24 V DC	CNS024VDC	44,34
24 V AC	CNS024VAC	44,34
110 V AV	CNS110VAC	44,34
230 V AC	CNS230VAC	44,34

Conector VA.

Posición 22.

Válvula	Ref.	€
S1	SETS1	2,48
S2	SETS2	3,43

Juego juntas secundario.

Posiciones 2-5-20.

Válvula	Ref.EPDM	€	Ref.FKM	€
S1	SHS1E	35,78	SHS1F	70,51
S2	SHS2E	38,85	SHS2F	89,46

Obturator.

Posición 8.

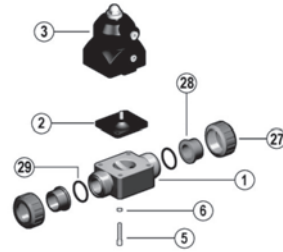

CM/CP

Válvulas de membrana compactas neumáticas CM/CP.

d	DN	DN	Ref. Normalmente cerrado NC	€	Ref. Normalmente abierto NO	€	Ref. Doble efecto DE	€
16-20	10-15	EPDM / FKM	ATCMNC	180,97	ATCMNO	180,97	ATCMDA	180,97
16-20	10-15	PTFE	ATCMNCPQ	Consultar	ATCMNOPQ	Consultar	ATCMDAPPQ	Consultar

Actuador neumático CM/CP.
 Posición 3.

* Estándar en los filtros de PVC-U

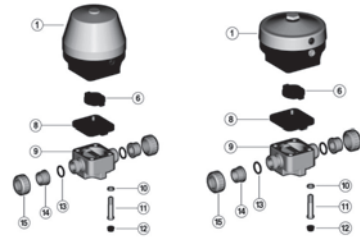

VM/CP

Válvulas de membrana neumáticas VM/CP.

d	DN	Ref. Normalmente cerrado NC	€	Ref. Normalmente abierto NO	€	Ref. Doble efecto DE	€
90	80	ATVMNC075090	1.596,63	ATVMNO075090	997,92	ATVMDA075090	1.663,18
110	100	ATVMNC110	2.058,60	ATVMNO110	1.452,52	ATVMDA110	1.663,18

Actuador neumático VM/CP.
 Posiciones 1-6.

d	DN	Ref.	€
90	80	COVMMN075090	144,15
110	100	COVMMN110	155,24

Compresor VM/CP.
 Posición 6.



DK/CP

Válvula de membrana neumática DK/CP

d	DN	Ref. EPDM	€	Ref. FKM	€	Ref. PTFE	€	Ref. NBR	€
20	15	DIA025E	32,93	DIA025F	107,36	DIADK025P	127,59	DIA025N	32,93
25	20	DIA025E	32,93	DIA025F	107,36	DIADK025P	127,59	DIA025N	32,93
32	25	DIA032E	34,38	DIA032F	118,87	DIADK032P	145,52	DIA032N	34,38
40	32	DIA032E	34,38	DIA032F	118,87	DIADK032P	145,52	DIA032N	34,38
50	40	DIA050E	42,23	DIA050F	201,85	DIADK050P	240,99	DIA050N	42,23
63	50	DIA063E	62,61	DIA063F	287,98	DIADK063P	295,66	DIA063N	62,61
75	65	DIA063E	62,61	DIA063F	287,98	DIADK063P	268,16	DIA063N	62,61

Membrana DK/CP. Posición 7.

d	DN	Ref. PVC-U	€	Ref. C-PVC	€	Ref. PP-H	€	Ref. PVDF	€
20	15	SPBDDK020DV	38,77	SPBDDK020DC	56,97	SPBDDK020DM	52,56	SPBDDK020DF	155,11
25	20	SPBDDK025DV	41,78	SPBDDK025DC	65,77	SPBDDK025DM	58,47	SPBDDK025DF	166,67
32	25	SPBDDK032DV	56,12	SPBDDK032DC	89,80	SPBDDK032DM	82,53	SPBDDK032DF	205,21
40	32	SPBDDK040DV	60,01	SPBDDK040DC	103,58	SPBDDK040DM	83,06	SPBDDK040DF	300,12
50	40	SPBDDK050DV	73,66	SPBDDK063DC	140,61	SPBDDK063DM	168,39	SPBDDK050DF	367,34
63	50	SPBDDK063DV	96,67	SPBDDK050DC	135,08	SPBDDK050DM	140,37	SPBDDK063DF	494,50
75	65	SPBDDK075DV	135,30	SPBDDK075DC	196,86	SPBDDK075DM	235,74	SPBDDK075DF	692,29

Cuerpo M-M DK/CP. Posición 8.

d	DN	Ref. PVC-U	€	Ref. C-PVC	€	Ref. PP-H	€	Ref. PVDF	€
20	15	UNBDDK020V	41,15	UNBDDK020C	98,85	UNBDDK020M	91,72	UNBDDK020F	164,51
25	20	UNBDDK025V	45,96	UNBDDK025C	111,85	UNBDDK025M	98,46	UNBDDK025F	183,42
32	25	UNBDDK032V	62,30	UNBDDK032C	151,36	UNBDDK032M	124,60	UNBDDK032F	227,78
40	32	UNBDDK040V	69,40	UNBDDK040C	175,39	UNBDDK040M	138,86	UNBDDK040F	335,68
50	40	UNBDDK050V	93,07	UNBDDK050C	221,58	UNBDDK050M	177,26	UNBDDK050F	385,96
63	50	UNBDDK063V	118,92	UNBDDK063C	265,32	UNBDDK063M	219,61	UNBDDK063F	522,79

Cuerpo con enlaces DKU/CP. Posición 8.

d	DN	Ref. PVC-U	€	Ref. C-PVC	€	Ref. PP-H	€	Ref. PVDF	€
20	15	FLBDDK020OV	102,81	FLBDDK020OC	173,75	FLBDDK020OM	144,81	FLBDDK020OF	356,62
25	20	FLBDDK025OV	116,24	FLBDDK025OC	203,55	FLBDDK025OM	158,47	FLBDDK025OF	373,76
32	25	FLBDDK032OV	145,68	FLBDDK032OC	241,63	FLBDDK032OM	201,27	FLBDDK032OF	432,82
40	32	FLBDDK040OV	180,33	FLBDDK040OC	296,56	FLBDDK040OM	244,58	FLBDDK040OF	686,64
50	40	FLBDDK050OV	227,36	FLBDDK050OC	358,29	FLBDDK050OM	305,12	FLBDDK050OF	769,60
63	50	FLBDDK063OV	282,78	FLBDDK063OC	445,52	FLBDDK063OM	383,48	FLBDDK063OF	990,67

Cuerpo con bridas DIN DKO/CP. Posición 8.

d	DN	Ref. PVC-U	€	Ref. C-PVC	€	Ref. PP-H	€	Ref. PVDF	€
½"	15	FLBDDK012OAV	96,70	FLBDDK012OAC	163,40	FLBDDK012OAM	136,20	FLBDDK012OAF	257,96
¾"	20	FLBDDK034OAV	109,37	FLBDDK034OAC	191,42	FLBDDK034OAM	149,04	FLBDDK034OAF	270,40
1"	25	FLBDDK100OAV	137,01	FLBDDK100OAC	227,25	FLBDDK100OAM	189,28	FLBDDK100OAF	313,06
1 ¼"	32	FLBDDK114OAV	169,56	FLBDDK114OAC	278,88	FLBDDK114OAM	229,98	FLBDDK114OAF	496,70
1 ½"	40	FLBDDK112OAV	213,83	FLBDDK112OAC	336,92	FLBDDK112OAM	286,93	FLBDDK112OAF	556,67
2"	50	FLBDDK200OAV	265,88	FLBDDK200OAC	418,94	FLBDDK200OAM	360,62	FLBDDK200OAF	716,60

Cuerpo con bridas ANSI 150 lbs DKO/CP. Posición 8.

Continúa en la página siguiente...

d	DN	Referencia	€	d	DN	Ref.NC	€	Ref.NO	€	Ref.DE	€
20	15	CODK020025	20,55	20	15	ATDKNC020025	253,83	ATDKNO020025	225,38	ATDKDA020025	162,71
25	20	CODK020025	20,55	25	20	ATDKNC020025	253,83	ATDKNO020025	225,38	ATDKDA020025	162,71
32	25	CODK032040	22,47	32	25	ATDKNC032040	Consultar	ATDKNO032040	226,99	ATDKDA032040	353,07
40	32	CODK032040	22,47	40	32	ATDKNC032040	Consultar	ATDKNO032040	226,99	ATDKDA032040	353,07
50	40	COVMMN040050	28,69	50	40	ATDKNC050	428,79	ATDKNO050	292,59	ATDKDA050	265,99
63	50	COVMMN063	37,21	63	50	ATDKNC063075	664,40	ATDKNO063075	417,68	ATDKDA063075	379,73
75	65	COVMMN063	37,21	75	65	ATDKNC063075	664,40	ATDKNO063075	417,68	ATDKDA063075	379,73

Compresor DK. Posición 6.

Actuador neumático DK/CP. Posiciones 1-2-3-4-6.

d	DN	Referencia	€	d	DN	Referencia	€
20	15	BSDK020025X	27,34	20+75	15+65	TCSDKCP020075	Consultar
25	20	BSDK020025X	27,34	Tapón transparente DK. Posiciones 1-2-3.			
32	25	BSDK032040X	35,90				
40	32	BSDK032040X	35,90				
50	40	BSDK050X	40,90				
63	50	BSDK063075X	51,20				
75	65	BSDK063075X	51,20				

Cierres DK. Posiciones 12-13-14.



DKB/CP

Válvulas de membrana compactas neumáticas CM/CP.

d	DN	Ref. EPDM	€
20	15	DIA025E	32,93
25	20	DIA025E	32,93
32	25	DIA032E	34,38
40	32	DIA032E	34,38
50	40	DIA050E	42,23
63	50	DIA063E	62,61
75	65	DIA063E	62,61

Membrana DKB/CP. Posición 7.

d	DN	Ref. EPDM	€
20	15	ATDKBNC020025	252,06
25	20	ATDKBNC020025	252,06
32	25	ATDKBNC032040	268,14
40	32	ATDKBNC032040	268,14
50	40	ATDKBNC050	353,87
63	50	ATDKBNC063075	495,68
75	65	ATDKBNC063075	495,68

Actuador neumático DKB/CP. Posiciones 1-6.

d	DN	Ref. PVC-U	€	Ref. C-PVC	€	Ref. PP-H	€
25	15	SPBDDK020DV	38,77	SPBDDK020DC	56,97	SPBDDK020DM	52,56
32	25	SPBDDK025DV	41,78	SPBDDK040DC	103,58	SPBDDK025DM	58,47
50	40	SPBDDK032DV	56,12	SPBDDK032DC	89,80	SPBDDK032DM	82,53
40	32	SPBDDK040DV	60,01	SPBDDK025DC	65,77	SPBDDK040DM	83,06
20	20	SPBDDK050DV	73,66	SPBDDK063DC	140,61	SPBDDK050DM	140,37
63	50	SPBDDK063DV	96,67	SPBDDK050DC	135,08	SPBDDK063DM	168,39
75	65	SPBDDK075DV	135,30	SPBDDK075DC	196,86	SPBDDK075DM	235,74

Cuerpo M-M DKB/CP. Posición 8.

d	DN	Ref. PVC-U	€	Ref. C-PVC	€	Ref. PP-H	€
20	15	UNBDDK020V	41,15	UNBDDK020C	98,85	UNBDDK020M	91,72
25	20	UNBDDK025V	45,96	UNBDDK025C	111,85	UNBDDK025M	98,46
32	25	UNBDDK032V	62,30	UNBDDK032C	151,36	UNBDDK032M	124,60
40	32	UNBDDK040V	69,40	UNBDDK040C	175,39	UNBDDK040M	138,86
50	40	UNBDDK050V	93,07	UNBDDK050C	221,58	UNBDDK050M	177,26
63	50	UNBDDK063V	118,92	UNBDDK063C	265,32	UNBDDK063M	219,61

Cuerpo con enlaces DKBU/CP. Posición 8.

d	DN	Ref. PVC-U	€	Ref. C-PVC	€	Ref. PP-H	€
20	15	FLBDDK020OV	102,81	FLBDDK020OC	173,75	FLBDDK020OM	144,81
25	20	FLBDDK025OV	116,24	FLBDDK025OC	203,55	FLBDDK032OM	201,27
32	25	FLBDDK032OV	145,68	FLBDDK032OC	241,63	FLBDDK025OM	158,47
40	32	FLBDDK040OV	180,33	FLBDDK040OC	296,56	FLBDDK050OM	305,12
50	40	FLBDDK050OV	227,36	FLBDDK050OC	358,29	FLBDDK040OM	244,58
63	50	FLBDDK063OV	282,78	FLBDDK063OC	445,52	FLBDDK063OM	383,48

Cuerpo con bridas DIN DKBO/CP. Posición 8.

d	DN	Ref. PVC-U	€	Ref. C-PVC	€	Ref. PP-H	€
½"	15	FLBDDK012OAV	96,70	FLBDDK012OAC	163,40	FLBDDK012OAM	136,20
¾"	20	FLBDDK034OAV	109,37	FLBDDK034OAC	191,42	FLBDDK034OAM	149,04
1"	25	FLBDDK100OAV	137,01	FLBDDK100OAC	227,25	FLBDDK100OAM	189,28
1 ¼"	32	FLBDDK114OAV	169,56	FLBDDK114OAC	278,88	FLBDDK114OAM	229,98
1 ½"	40	FLBDDK112OAV	213,83	FLBDDK112OAC	336,92	FLBDDK112OAM	286,93
2"	50	FLBDDK200OAV	265,88	FLBDDK200OAC	418,94	FLBDDK200OAM	360,62

Cuerpo con bridas ANSI 150 lbs DKBO/CP. Posición 8.

d	DN	Ref. EPDM	€
20	15	BSDK020025X	27,34
25	20	BSDK020025X	27,34
32	25	BSDK032040X	35,90
40	32	BSDK032040X	35,90
50	40	BSDK050X	40,90
63	50	BSDK063075X	51,20
75	65	BSDK063075X	51,20

Mcierres DKB. Posición 12-13-14.

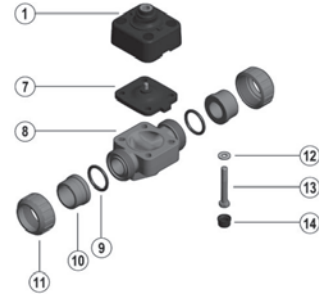

DKD/CP

Válvulas de membrana neumática DKD/CP.

d	DN	Ref. EPDM	€
20	15	DIADKD025E	Consultar
25	20	DIADKD025E	Consultar
32	25	DIA032E	34,38
40	32	DIA032E	34,38
50	40	DIA050E	42,23
63	50	DIA063E	62,61
75	65	DIA063E	62,61

Membrana DKD / CP. Posición 7.

d	DN	Ref. PVC-U	€
20	15	SPBDDK020DV	38,77
25	20	SPBDDK025DV	41,78
32	25	SPBDDK032DV	56,12
40	32	SPBDDK040DV	60,01
50	40	SPBDDK050DV	73,66
63	50	SPBDDK063DV	96,67
75	65	SPBDDK075DV	135,30

Cuerpo DKDD...
 Posición 8.

M-M encolar

d	DN	Ref. PVC-U	€
20	15	UNBDDK020V	41,15
25	20	UNBDDK025V	45,96
32	25	UNBDDK032V	62,30
40	32	UNBDDK040V	69,40
50	40	UNBDDK050V	93,07
63	50	UNBDDK063V	118,92

Cuerpo DKDU...
 Posición 8.

H-H encolar con enlaces

d	DN	Ref.	€
20÷25	15÷20	BODKD020025	36,81
32÷40	25÷32	BODKD032040	39,22
50	40	BODKD050	65,31
63÷75	50÷65	BODKD063075	95,03

Cubierta DKD/CP.
 Posición 1.

d	DN	Ref.	€
20÷25	15÷20	BSDK020025X	27,34
32÷40	25÷32	BSVM020032X	37,69
50	40	BSVM040050X	44,34
63÷75	50÷65	BSVM063X	55,54

Cierres DKD/CP.
 Posiciones 12-13-14.



Parte LOCA



Parte FIJA



TUERCA



PVC-U



PP-H



C-PVC



PVDF

Bl...

Uniones 3 piezas en PVC-U.

d	Ref.	€
16	QBIV016	0,71
20	QBIV020	0,71
25	QBIV025	0,74
32	QBIV032	0,93
40	QBIV040	1,06
50	QBIV050	1,45
63	QBIV063	1,93
75	QBIV075	4,57
90	QBIV090	5,81
110	QBIV110	11,28

Parte loca. *H encolar.*

d	Ref.	€
16	FBIV016	0,93
20	FBIV020	0,93
25	FBIV025	1,11
32	FBIV032	1,59
40	FBIV040	1,87
50	FBIV050	2,53
63	FBIV063	3,75
75	FBIV075	10,45
90	FBIV090	13,47
110	FBIV110	19,96

Parte fija. *H encolar.*

d	Ref.	€
16	EFV034	0,94
20	EFV100	1,25
25	EFV114	2,64
32	EFV112	2,85
40	EFV200	3,31
50	EFV214	2,85
63	EFV234	5,12
75	EFV312	21,55
90	EFV400	29,87
110	EFV500	39,22

Tuerca. *H roscar.*

Rh	Ref.	€
3/8"	QBFV038	3,37
1/2"	QBFV012	4,54
3/4"	QBFV034	5,37
1"	QBFV100	9,88
1 1/4"	QBFV114	10,30
1 1/2"	QBFV112	12,09
2"	QBFV200	15,90

Parte loca. *H roscar.*

Rh	Ref.	€
3/8"	FBFV038	4,86
1/2"	FBFV012	5,91
3/4"	FBFV034	6,63
1"	FBFV100	8,88
1 1/4"	FBFV114	10,83
1 1/2"	FBFV112	15,72
2"	FBFV200	20,41

Parte fija. *H roscar.*

Uniones 3 piezas en PP-H.

d	Ref.	€
20	QBIGM020	4,34
25	QBIGM025	4,39
32	QBIGM032	4,70
40	QBIGM040	5,81
50	QBIGM050	6,94
63	QBIGM063	7,40

Parte loca. *H soldar.*

d	Ref.	€
20	FBIGM020	8,43
25	FBIGM025	9,27
32	FBIGM032	10,62
40	FBIGM040	13,86
50	FBIGM050	19,65
63	FBIGM063	26,12

Parte fija. *H soldar.*

d	Ref.	€
20	EFGM100	8,27
25	EFGM114	8,56
32	EFGM112	9,93
40	EFGM200	12,68
50	EFGM214	19,65
63	EFGM234	31,66

Tuerca. *H roscar.*

Continúa en la página siguiente...



Parte LOCA



Parte FIJA



TUERCA



PVC-U



PP-H



C-PVC



PVDF

Uniones 3 piezas en C-PVC.

d	Ref.	€
16	QBIC016	10,22
20	QBIC020	10,17
25	QBIC025	11,89
32	QBIC032	15,45
40	QBIC040	18,96
50	QBIC050	29,75
63	QBIC063	33,67

Parte loca. *H encolar.*

d	Ref.	€
16	FBIC016	8,48
20	FBIC020	8,58
25	FBIC025	9,85
32	FBIC032	14,39
40	FBIC040	18,44
50	FBIC050	24,33
63	FBIC063	28,99

Parte fija. *H encolar.*

d	Ref.	€
16	EFC034	8,16
20	EFC100	6,80
25	EFC114	7,92
32	EFC112	15,26
40	EFC200	17,36
50	EFC214	28,45
63	EFC234	45,29

Tuerca. *H roscar.*

Rh	Ref.	€
3/8"	QBFC038	Consultar
1/2"	QBFC012	17,29
3/4"	QBFC034	19,20
1"	QBFC100	22,58
1 1/4"	QBFC114	26,44
1 1/2"	QBFC112	29,84
2"	QBFC200	40,41

Parte loca. *H roscar.*

Rh	Ref.	€
3/8"	FBFC038	9,74
1/2"	FBFC012	11,67
3/4"	FBFC034	13,31
1"	FBFC100	17,90
1 1/4"	FBFC114	21,13
1 1/2"	FBFC112	29,29
2"	FBFC200	40,64

Parte fija. *H roscar.*

Uniones 3 piezas en PVDF.

d	Ref.	€
20	QBIGF020	16,80
25	QBIGF025	21,73
32	QBIGF032	24,22
40	QBIGF040	30,90
50	QBIGF050	35,21
63	QBIGF063	48,83

Parte loca. *H soldar.*

d	Ref.	€
20	FBIGF020	24,94
25	FBIGF025	32,62
32	FBIGF032	35,92
40	FBIGF040	46,22
50	FBIGF050	62,36
63	FBIGF063	97,75

Parte fija. *H soldar.*

d	Ref.	€
20	EFGF100	27,71
25	EFGF114	37,79
32	EFGF112	46,88
40	EFGF200	64,44
50	EFGF214	94,00
63	EFGF234	146,16

Tuerca. *H roscar.*

Juntas para uniones 3 piezas



d	Ref.	€
16	OR3062E	2,01
20	OR4081E	5,73
25	OR4112E	2,06
32	OR4131E	2,94
40	OR6162E	3,12
50	OR6187E	3,31
63	OR6237E	3,62
75	OR6300E	7,24
90	OR6362E	10,83
110	OR6450E	14,29

Junta tórica. *En EPDM.*



d	Ref.	€
16	OR3062F	4,93
20	OR4081F	15,16
25	OR4112F	2,85
32	OR4131F	8,05
40	OR6162F	11,89
50	OR6187F	13,54
63	OR6237F	15,16
75	OR6300F	28,37
90	OR0185F	31,09
110	OR6450F	51,69

Junta tórica. *En FKM.*

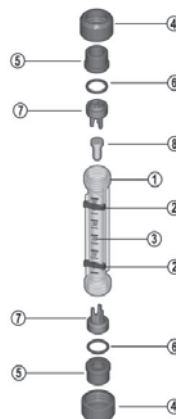

FC/FS

Flujómetros cortos (FC) y largos (FS).

d	DN	Ref. SS para líquidos	€	Ref. SS + M para líquidos	€	Ref. PP para líquidos	€	Ref. PP + M para líquidos	€
16	10	FL016X	42,65	FL016XM	131,79	FL016M	42,65	FL016MM	131,79
20	15	FL020X	46,48	FL020XM	151,14	FL020M	46,48	FL020MM	151,14
25	20	FL025X	52,34	FL025XM	156,95	FL025M	52,31	FL025MM	156,95
32	25	FL032X	58,13	FL032XM	193,74	FL032M	58,13	FL032MM	193,74
40	32	FL040X	108,52	FL040XM	251,90	FL040M	108,52	FL040MM	251,90
50	40	FL050X	135,64	FL050XM	290,65	FL050M	135,64	FL050MM	290,65
63	50	FL063X	213,13	FL063XM	387,55	FL063M	213,13	FL063MM	387,55
75	65	FL075X	437,90	FL075XM	817,69	FL075M	437,90	FL075MM	817,69
75 cuerpo 68	65	FL07568X	437,90	FL07568XM	817,69	FL07568M	437,90	FL07568MM	817,69

d	DN	Ref. PP para gases	€	Ref. PP + M para gases	€
16	10	FL016GM	42,65	FL016GMM	131,79
20	15	FL020GM	46,48	FL020GMM	151,14
25	20	FL025GM	52,34	FL025GMM	156,95
32	25	FL032GM	58,13	FL032GMM	193,74
40	32	FL040GM	108,52	FL040GMM	251,90
50	40	FL050GM	135,64	FL050GMM	290,65
63	50	FL063GM	213,13	FL063GMM	387,55
75	65	FL075GM	437,90	FL075GMM	817,69

Flotador FC y FS. Posición 8.

d	DN	Ref.Serie FC	€	Ref.Serie FS	€
16	10	STFC016P	26,20		
20	15	STFC020P	26,20		
25	20	STFC025P	27,17	STFS025P	27,17
32	25	STFC032P	29,74	STFS032P	29,74
40	32			STFS040P	42,84
50	40			STFS050P	46,80
63	50			STFS063P	58,42
75	65			STFS075PINF	110,82
75 cuerpo 68	65			STFS075PSUP	110,82

Topes flotador FC y FS. Posición 7.

Se necesita 1 pieza para la serie FC y 2 piezas para la serie FS (precio por unidad)

Continúa en la página siguiente...

Ref.	Descripción	€
VFI01	Indicadores visuales para FS y FC d 32 (2 piezas)	3,85
VFI02	Indicadores visuales para FC 16, 20 y d 25 (2 piezas)	3,85

Indicadores visuales de caudal FC y FS.

Posición 2.



d	Ref.	€
16	OR3062E	2,01
20	OR4081E	5,73
25	OR4112E	2,06
32	OR4131E	2,94
40	OR0150E	4,17
50	OR4200E	3,70
63	OR4275E	5,76
75	OR6325E	9,32

Junta tórica en EPDM.

Posición 6.



d	Ref.	€
16	OR3062F	4,93
20	OR4081F	15,16
25	OR4112F	2,85
32	OR4131F	8,05
40	OR0150F	15,87
50	OR4200F	12,39
63	OR4275F	19,70
75	OR6325F	31,61

Junta tórica en FKM.

Posición 6.

No se trata solo de lo que hacemos, sino de **cómo lo hacemos**. Desde la **sostenibilidad y el compromiso social**, compartimos un mismo propósito de generar un impacto positivo en el mundo.

Transformando comunidades a través de soluciones innovadoras

Reducimos el impacto en nuestro entorno a través de **prácticas responsables y respetuosas** con el medio ambiente.

Nuestro proyecto de desarrollo sostenible



Contribuimos con los siguientes Objetivos de Desarrollo Sostenible:



AENOR
Confía

Certificado del
Sistema de Gestión de la Calidad



ER-0288/1996

AENOR certifica que la organización

ALIAXIS IBERIA, S.A.U.

dispone de un sistema de gestión de la calidad conforme con la Norma ISO 9001:2015

para las actividades: A) La producción de tuberías de polietileno entre 20 mm. y 1000 mm. de diámetro. La producción de Push-Fast y accesorios manipulados para tuberías de polietileno. La comercialización de tubos, accesorios para tubería y valvulería. B) Comercialización y postventa de máquinas electrosoldables y de herramientas relacionadas con la electrosoldadura.

que se realizan en: A) PI ZUDIBIARTE, S/N - PABELLONES A y C. 01409-OKONDO (ARABA/ALAVA) B) ANABEL SEGURA 11, EDIFICIO A 1º 3. 28108 - MADRID C) CL.SALAS BARBADILLO, 12 LOCAL E. 28017 - MADRID

Fecha de primera emisión: 1996-06-24
Fecha de última emisión: 2021-10-07
Fecha de expiración: 2024-10-07

Rafael GARCÍA MEIRO
Director General

AENOR INTERNACIONAL S.A.U.
Génova, 6. 28004 Madrid, España
Tel. 91 432 60 00 - www.aenor.com



THE INTERNATIONAL CERTIFICATION NETWORK

CERTIFICATE

AENOR has issued an IQNet recognized certificate that the organization:

ALIAXIS IBERIA, S.A.U.

A) PI ZUDIBIARTE, S/N - PABELLONES A y C. 01409 - OKONDO (ARABA/ALAVA) B) ANABEL SEGURA 11, EDIFICIO A 1º 3. 28108 - MADRID C) CL.SALAS BARBADILLO, 12 LOCAL E. 28017 - MADRID

has implemented and maintains a

Quality Management System

for the following scope:

A) Production of polyethylene pipes diameters from 20 mm. up to 1000 mm. Production of Push-Fast and fabricated fittings for PE pipes. Bought in pipes, fittings and valves activity. B) Trading and after sales service of electrofusion machines and other electrofusion related toolings.

which fulfills the requirements of the following standard

ISO 9001:2015

First issued on: 1999-08-01 Last issued: 2021-10-07 Validity date: 2024-10-07

This attestation is directly linked to the IQNet Partner's original certificate and shall not be used as a stand-alone document

Registration Number: ES-0288/1996



Alex Stokichitua
President of IQNet

Rafael GARCÍA MEIRO
Chief Executive Officer

AENOR

IQNet Partners:
AENOR Spain, AFNOR Certification France, APCER Portugal, CCC Cyprus, CSQ Italy, CQC China, CQM China, CQS Czech Republic, Cst Cert Canada, DQS Holding GmbH Germany, EAGLE & CO Certification Group USA, FCSI Brazil, FONCER, GIRA, Venetia, KORYTEC Colombia, Inspiree Certification Oy Finland, ISTECO Costa Rica, IRAM Argentina, JQA Japan, KPC Korea, METREC Greece, MIZT Hungary, Nivalis AS Norway, NTAI Ireland, NVIS-SDS Mexico, PSC, Pirena, Quality Austria Austria, RQI Pakistan, SII Israel, SQA Slovenia, SUREX-QAS International Malaysia, SGS Switzerland, SRAC Romania, TSETI SA Petersburg Russia, TSE Turkey, YUQS Serbia

* The list of IQNet partners is valid at the time of issue of this certificate. Updated information is available under www.iqnet-certification.com

AENOR
Confía

Certificado del
Sistema de Gestión Ambiental



GA-2005/0349

AENOR certifica que la organización

ALIAXIS IBERIA S.A.U

dispone de un sistema de gestión ambiental conforme con la Norma ISO 14001:2015

para las actividades: La producción de tuberías de polietileno entre 20 mm. y 1000 mm. de diámetro. La producción de Push-Fast y accesorios manipulados para tuberías de polietileno. La comercialización de tubos, accesorios para tubería y valvulería.

que se realiza en: PI ZUDIBIARTE, S/N PABELLONES A, C y D. 01409-OKONDO (ARABA/ALAVA)

Primera emisión: 2005-08-02
Expiración: 2024-08-02
Última emisión: 2023-08-02

Rafael GARCÍA MEIRO
CEO

AENOR INTERNACIONAL S.A.U.
Génova, 6. 28004 Madrid, España
Tel. 91 432 60 00 - www.aenor.com



AENOR INTERNACIONAL S.A.U.
Génova, 6. 28004 Madrid, España
Tel. 91 432 60 00 - www.aenor.com



Building trust together.

Certificate

AENOR has issued an IQNET recognized certificate that the organization:

ALIAXIS IBERIA S.A.U

PI ZUDIBIARTE, S/N PABELLONES A, C y D. 01409 OKONDO (ARABA/ALAVA)

has implemented and maintains a/an
Environmental Management System

for the following scope:

Production of polyethylene pipes diameters from 20 mm. up to 1000 mm. Production of Push-Fast and fabricated fittings for PE pipes. Bought in pipes, fittings and valves activity.

which fulfills the requirements of the following standard

ISO 14001:2015

First issued on: 2005-08-02 Last issued: 2023-08-02 Validity date: 2024-08-02

Registration Number: ES-2005/0349

Alex Saichitlalu
President of IQNET

Rafael GARCÍA MEIRO
CEO

AENOR

This attestation is directly linked to the IQNET member's original certificate and shall not be used as a stand-alone document

IQNET Members:
AENOR Spain, AFNOR Certification France, APCER Portugal, CCC Cyprus, CSQ Italy, CQC China, COM China, CQS Czech Republic, Cst Cert Canada, DQS Holding GmbH Germany, EAGLE Certification Group USA, FCSI Brazil, FONCER, GIRA, Venetia, KORYTEC Colombia, KCS Bolivia and Paraguay, Inspiree Certification Oy Finland, ISTECO Costa Rica, IRAM Argentina, JQA Japan, KPC Korea, LGSA Uruguay, METREC Greece, MIZT Hungary, Nivalis AS Norway, NTAI Ireland, NVIS-SDS Mexico, PSC, Pirena, Quality Austria Austria, RQI Pakistan, SII Israel, SQA Slovenia, SUREX-QAS International Malaysia, SGS Switzerland, SRAC Romania, TSETI SA Petersburg Russia, TSE Turkey, YUQS Serbia

* The list of IQNET Members is valid at the time of issue of this certificate. Updated information is available under www.iqnet-certification.com

NOTA: Los datos facilitados en este catálogo, como consecuencia de la constante mejora y evolución de nuestros productos, pueden variar sin previo aviso.

Este catálogo no tiene carácter contractual, y toda la información se da de buena fe.

Declinamos cualquier responsabilidad derivada de la aplicación de los mismos.

La versión más actualizada de este catálogo la encontrará disponible en nuestra página web.

Normas Generales

PRECIOS: Los precios son de VENTA AL PÚBLICO (Recomendados) y pueden ser modificados sin previo aviso. Los precios no incluyen IVA.

EXPEDICIONES Y PEDIDOS: Para importes inferiores a 300€ se cobrará una tasa administrativa de 8€. La mercancía viaja siempre por cuenta y riesgo del comprador. Los pedidos serán siempre de cajas o camiones completos, en función de la naturaleza del producto y acuerdos comerciales. Las unidades mínimas de venta recogidas en la presente tarifa son de obligado cumplimiento, así como la venta por múltiplos de esta, conforme a los acuerdos comerciales en vigor. En caso que ALIAXIS IBERIA S.A.U. autorice enviar unidades sueltas, tendrán un recargo del 20% en concepto de manipulación.

PORTES: Los pedidos superiores a 600€, dentro de la Península disfrutarán de portes gratuitos. En el caso de Canarias los pedidos superiores a 1.500€ estarán igualmente exentos de cargo de portes.

Puede consultar los cargos por portes en el siguiente link: www.aliaxis.es/condicionescomerciales.

ALIAXIS IBERIA S.A.U. gestionará los envíos a las direcciones correspondientes al domicilio habitual del comprador. En caso, de necesitar un envío a la dirección de un tercero, se aplicará el correspondiente cargo por portes a terceros. Este importe puede consultarse en el siguiente enlace: www.aliaxis.es/condicionescomerciales

ANULACIONES DE PEDIDOS: No se admiten anulaciones de pedidos que ya estén fabricados, en curso de fabricación o sobre los que ya se haya emitido albarán para su envío y por tanto estén en transporte.

DEVOLUCIONES DE MATERIAL: No se admiten devoluciones de material, salvo por defecto imputable a la fabricación o a la gestión del transporte, en este último caso el comprador deberá inspeccionar las mercancías de forma inmediata tras su recepción. Cualquier desperfecto reconocible en el transcurso de la inspección rutinaria y que sea asumible por el transporte, deberá notificarse a ALIAXIS IBERIA S.A.U. por email en un plazo máximo de 3 días laborables tras su recepción, no pudiendo ser atendidas las reclamaciones que excedan ese periodo.

CONDICIONES DE ENTREGA: Los pedidos podrán ser suministrados y facturados en parte sin que ello suponga la anulación de los mismos.

CALIDAD Y GARANTÍA: La garantía de nuestros materiales queda limitada a la reposición del producto, modelo o pieza que sea reconocida como defectuosa. Igualmente cubre todos los daños a terceros mediante póliza de responsabilidad civil, siempre y cuando se hayan observado las especificaciones y prescripciones para su uso correcto e instalación descritas en la documentación técnica del producto. Dado las características de los materiales cualquier reclamación de calidad, deberá plantearse dentro de los 15 días naturales siguientes a la entrega del material. Cualquier utilización o uso de nuestros materiales para fines distintos a los que fueron fabricados eximirá de cualquier tipo de responsabilidad.

PAGOS: Los precios de la tarifa están considerados para pagos al contado. No obstante, previa clasificación del comprador, se podrá optar a otras condiciones de mercado en el marco de las normas vigentes, entre ellas la Ley 15/2010 de medidas contra la morosidad en las operaciones comerciales. Los pagares y cheques tan solo se consideran aceptados por ALIAXIS IBERIA S.A.U. en el momento en el que se hagan efectivos, no constituyendo en ningún caso la entrega de los mismos el cumplimiento de la obligación correspondiente.

Anexo 1: En caso de que la mora, la insolvencia o las deudas por parte del comprador hagan peligrar la solvencia de ALIAXIS IBERIA S.A.U. estará facultada para exigir de forma inmediata la liquidación de todas las cantidades adeudadas o la provisión de garantías, tanto en ese momento como en futuros. ALIAXIS IBERIA S.A.U. podrá realizar únicamente las entregas pendientes en caso de que estas se hayan abonado por adelantado o se hayan presentado las garantías suficientes. En caso de que el comprador no pueda cumplir lo anterior en un periodo razonable de tiempo ALIAXIS IBERIA S.A.U. podrá rescindir el contrato de venta.

COMERCIALIZACIÓN: El comprador se compromete a no vender, transferir, transbordar o disponer de ninguna otra manera de los Productos (i) a individuos y/o entidades objeto de sanciones financieras o económicas; y/o (ii) con conocimiento o razón para creer que el comprador y/o usuario final puede utilizar los productos para cualquier uso final prohibido (como en relación con armas nucleares, químicas o biológicas o misiles, cualquier otro uso final militar en un país sujeto a un embargo de armas o como piezas para artículos militares). Además, el comprador se compromete a proporcionar a ALIAXIS IBERIA S.A.U. cualquier información necesaria para cumplir con las leyes y regulaciones de control y/o sanciones de exportación.

RESERVA DE PROPIEDAD: ALIAXIS IBERIA S.A.U. conservará la propiedad de las mercancías suministradas hasta que se abone el pago total del correspondiente precio de compra y se liquiden la totalidad de las deudas pendientes por parte del comprador a ALIAXIS IBERIA S.A.U. En los casos especificados en el Anexo 1, ALIAXIS IBERIA S.A.U. también podrá impedir la tramitación y la reventa de la mercancía entregada con efectos inmediatos. Una declaración de rescisión del contrato por parte de ALIAXIS IBERIA S.A.U. también se considerará una anulación de la autorización para revender y cobrar los derechos de reventa. En estos, caso ALIAXIS IBERIA S.A.U. también podrá exigir la devolución inmediata de las mercancías entregadas por cuenta del comprador.

PROHIBICIÓN DE CESIÓN: El comprador tan solo podrá ceder los derechos y las deudas dimanantes de contratos de venta a terceros con el consentimiento previo de ALIAXIS IBERIA S.A.U.

RESERVA: Nos reservamos el derecho a introducir modificaciones de diseño, medidas y unidades de embalaje en nuestros fabricados sin previo aviso.

COMPETENCIA JUDICIAL: Para resolver las cuestiones que puedan derivarse de la aplicación de estas Normas, tanto ALIAXIS IBERIA S.A.U. como comprador, convienen someterse a los Juzgados y Tribunales pertinentes renunciando a su propio fuero si fuese otro.

LIMITACIONES: Queda prohibida la reproducción total o parcial de esta tarifa sin la autorización expresa de ALIAXIS IBERIA S.A.U. Esta tarifa está sujeta a modificación sin previo aviso, todos los datos y especificaciones técnicas expresadas, se dan de buena fe y no tienen carácter contractual. Declinamos cualquier responsabilidad derivada de la aplicación de los mismos.

Somos la fuerza de todas nuestras marcas locales y un equipo global



Aliaxis Iberia, S.A.U.

C/ del Yen, s/n - Pol. Las Atalayas
03114 Alicante, España
+34 965 109 044

alixis.es

Empresa registrada según normas



Encuentra aquí nuestra
tarifa actualizada

